

***trans*-1,2-Disiloxybenzocyclobutene + O<sub>2</sub>  
&  
pseudopotentials for hybridized carbon atoms**

Yannick Carissan

***trans*-1,2-Disiloxybenzocyclobutene + O<sub>2</sub>**

## Secondary reaction in lactonamycinone synthesis

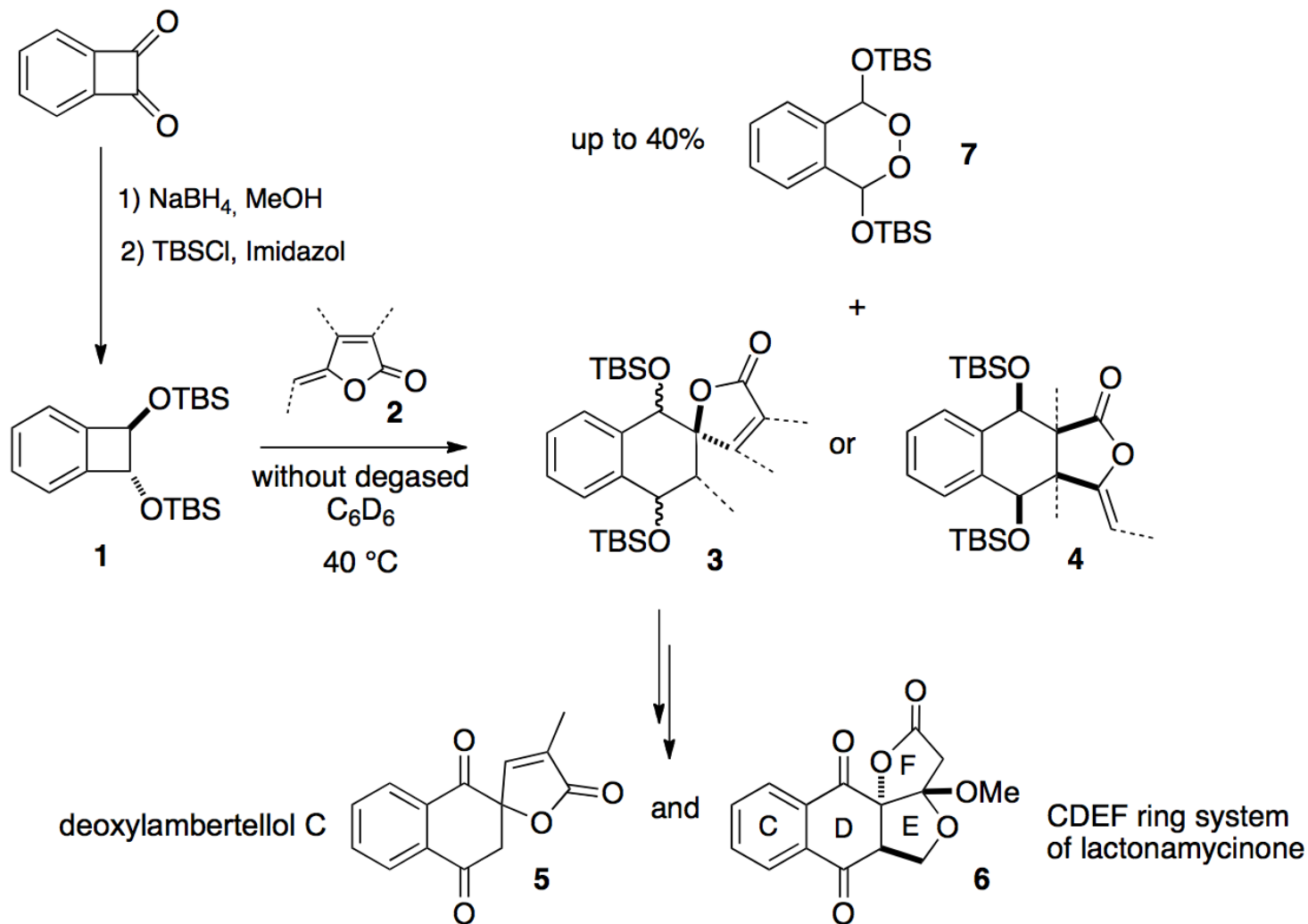

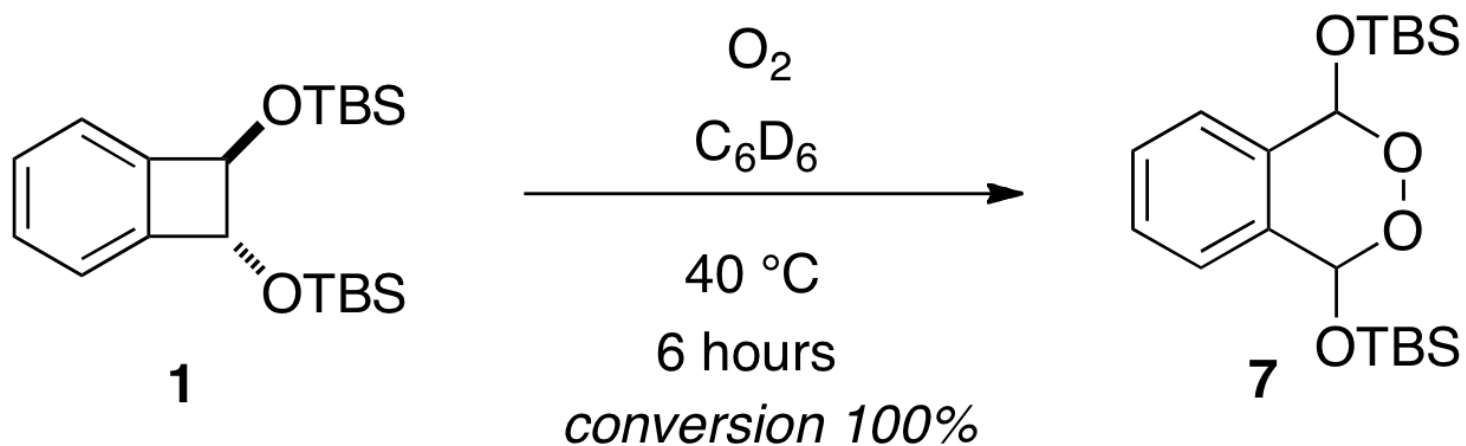
Reaction with O<sub>2</sub>

With benzocyclobutene same reaction at 190-240 °C. <sup>[1]</sup>

[1]. W. R. Roth, T. Ebbrecht, A. Breit *Chem.Ber.* **1988** *121*, 1357-1358

## Suggested pathway

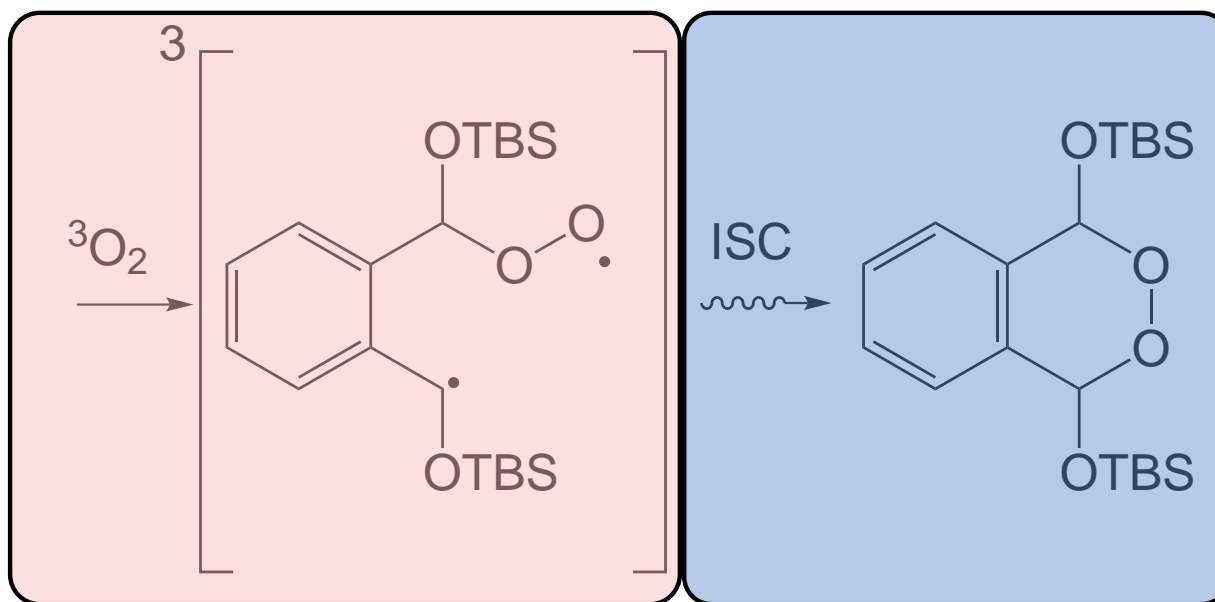
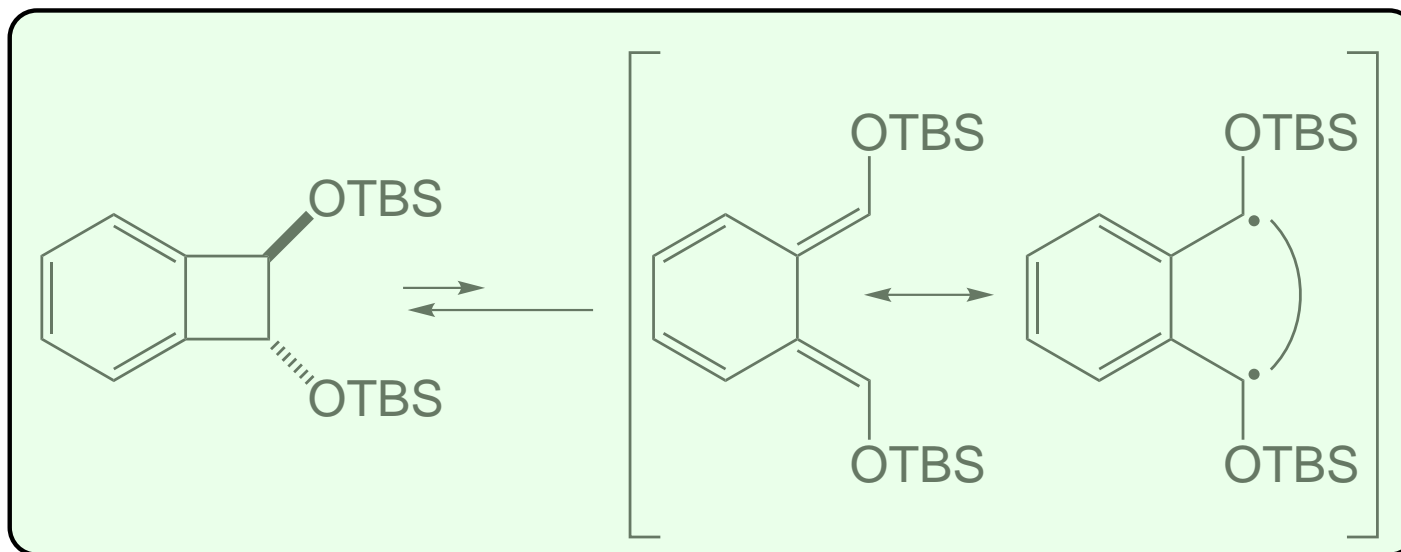

## Theory : opening and color



-20 °C



T amb.

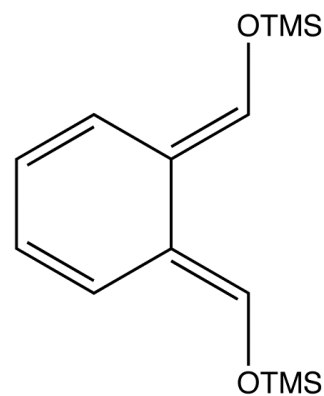
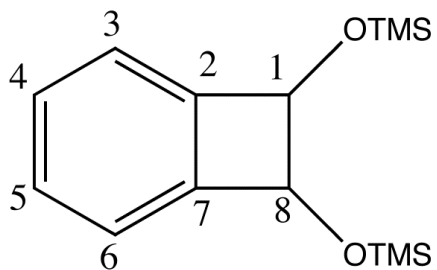

Ground and first excited state :

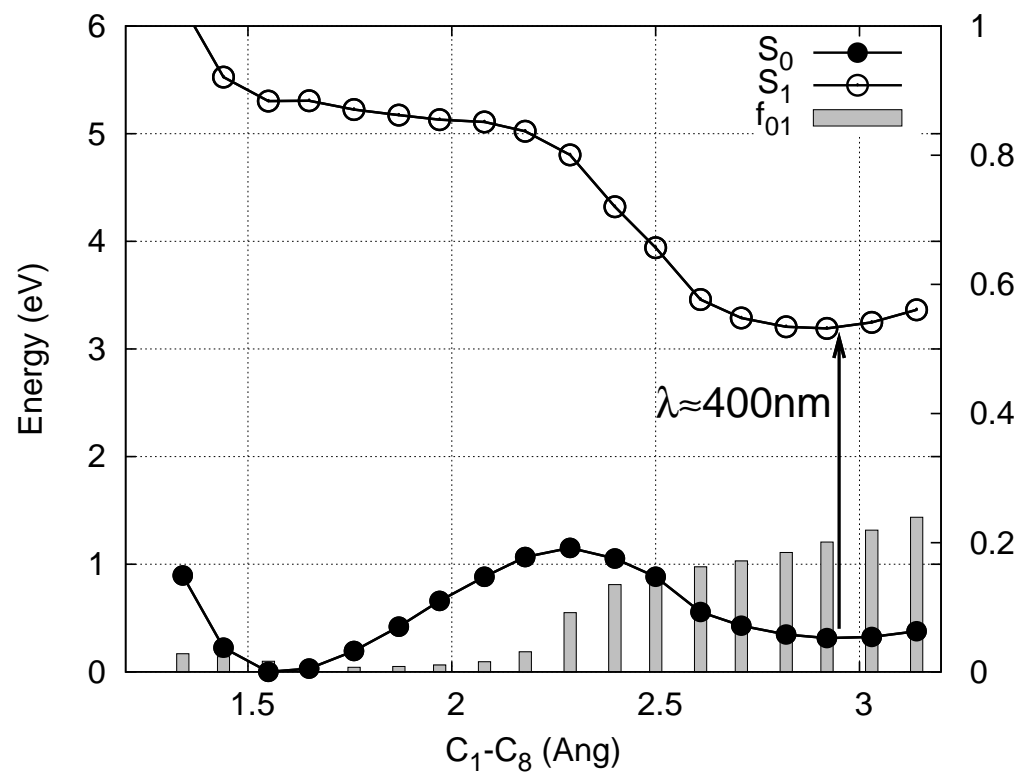

Absorbs blue : appears yellow

Exp : UV analysis

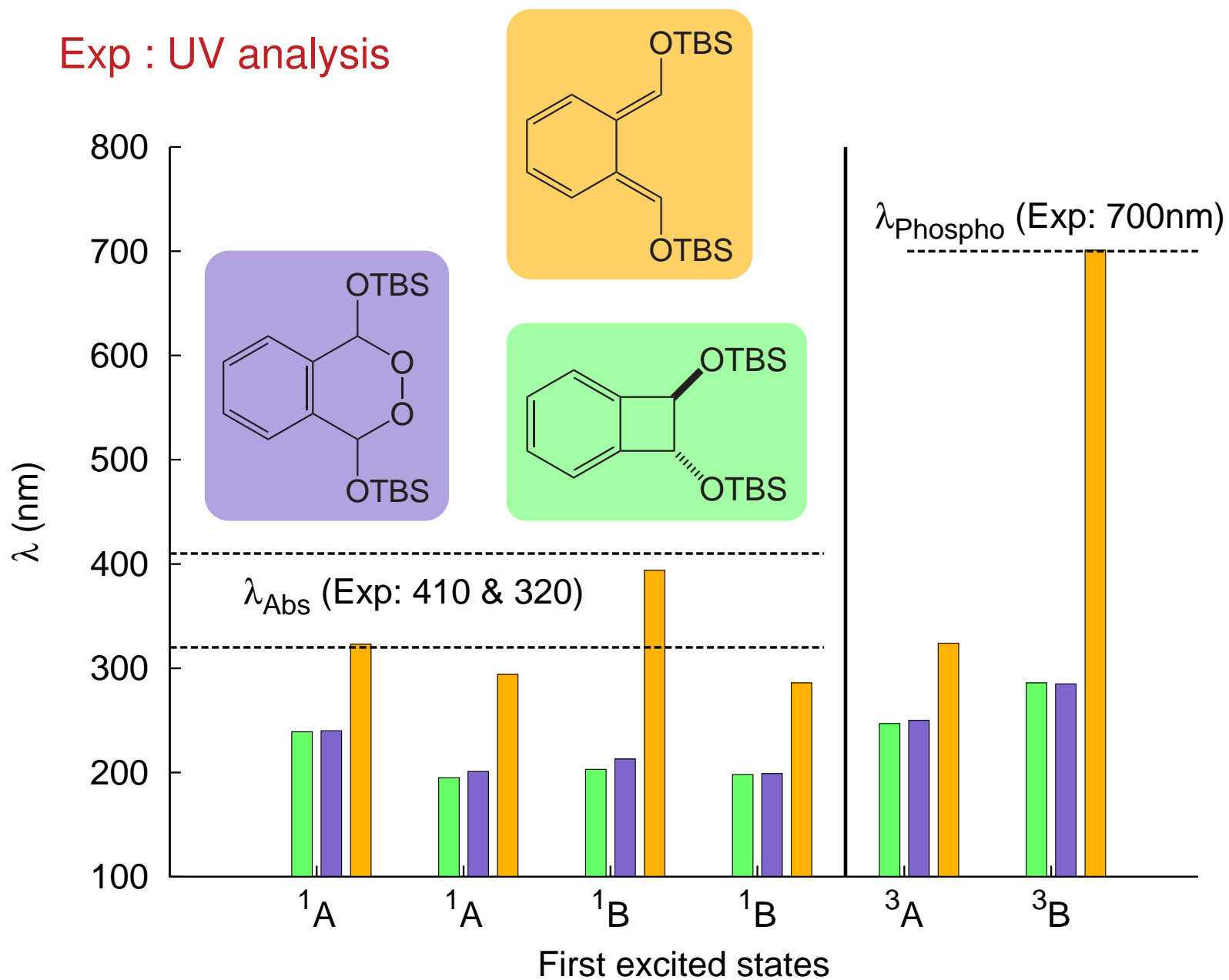

## Suggested pathway

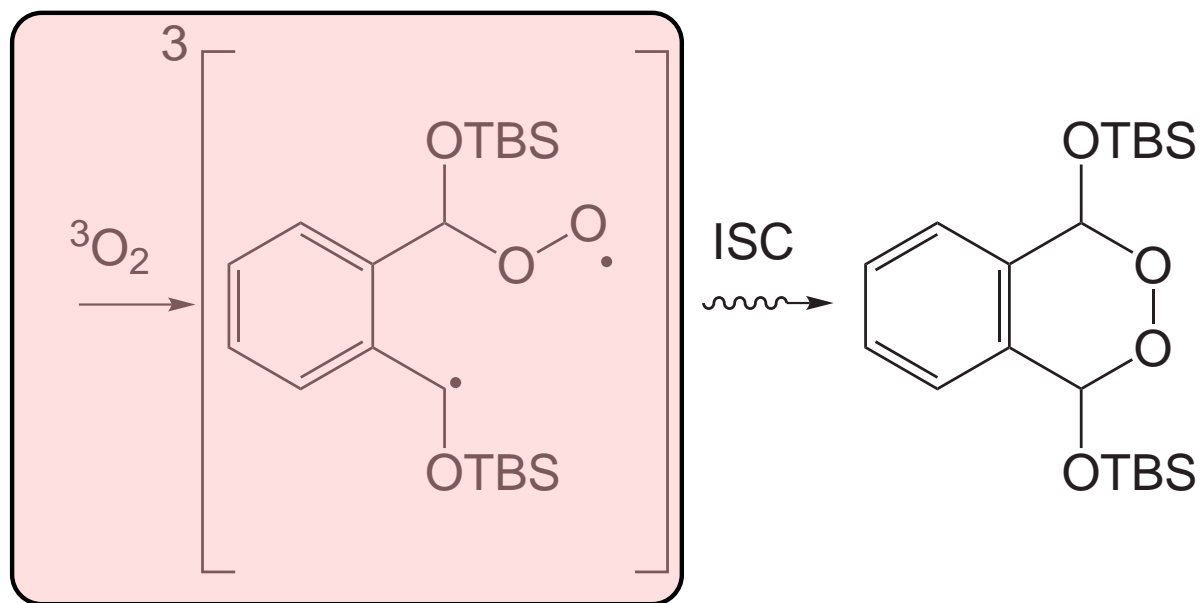
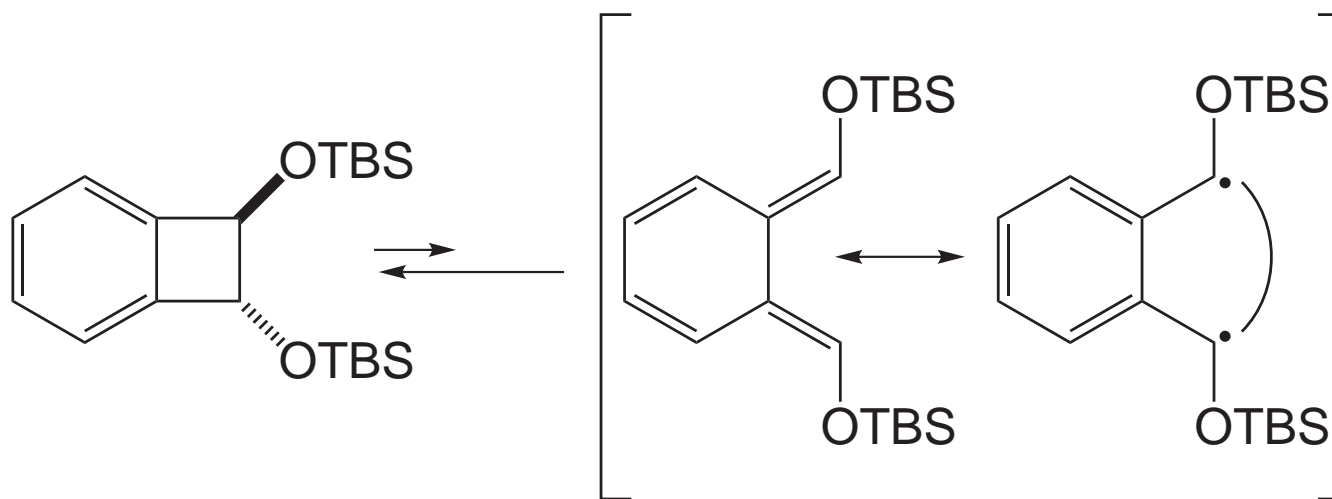



Intermediate exists

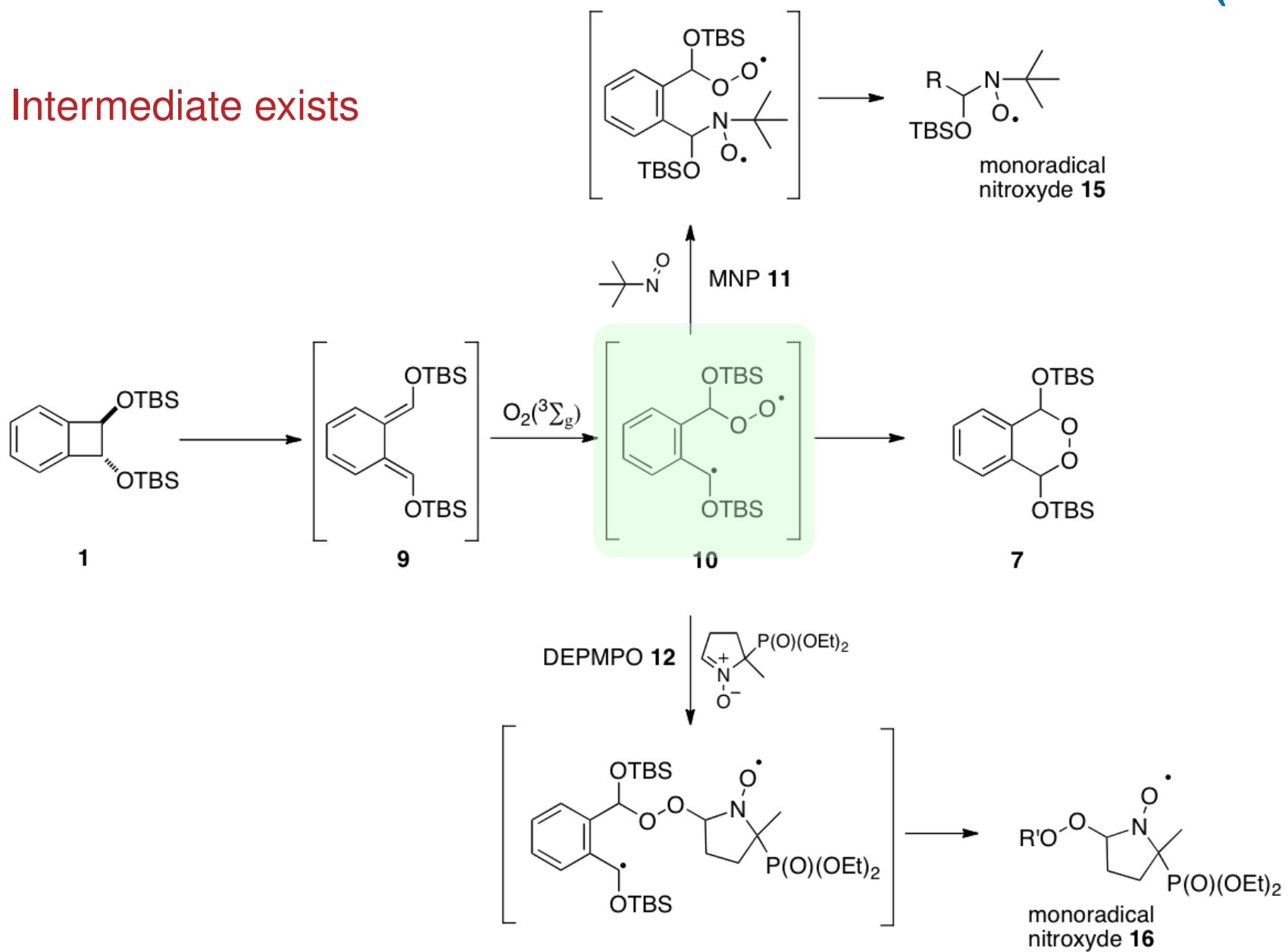

## Intermediate : proof of existence

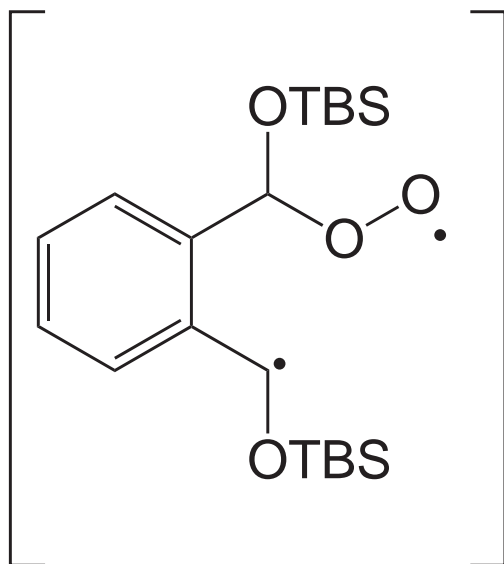

Energy	kJ/mol	cm <sup>-1</sup>
singlet	0.35	30
triplet	0	0

Transition state of O<sub>2</sub> approach at 15kcal/mol.

Spin trapping : the two radical centers are characterized.

Theory : Singlet and triplet states are quasi degenerated.

## Suggested pathway

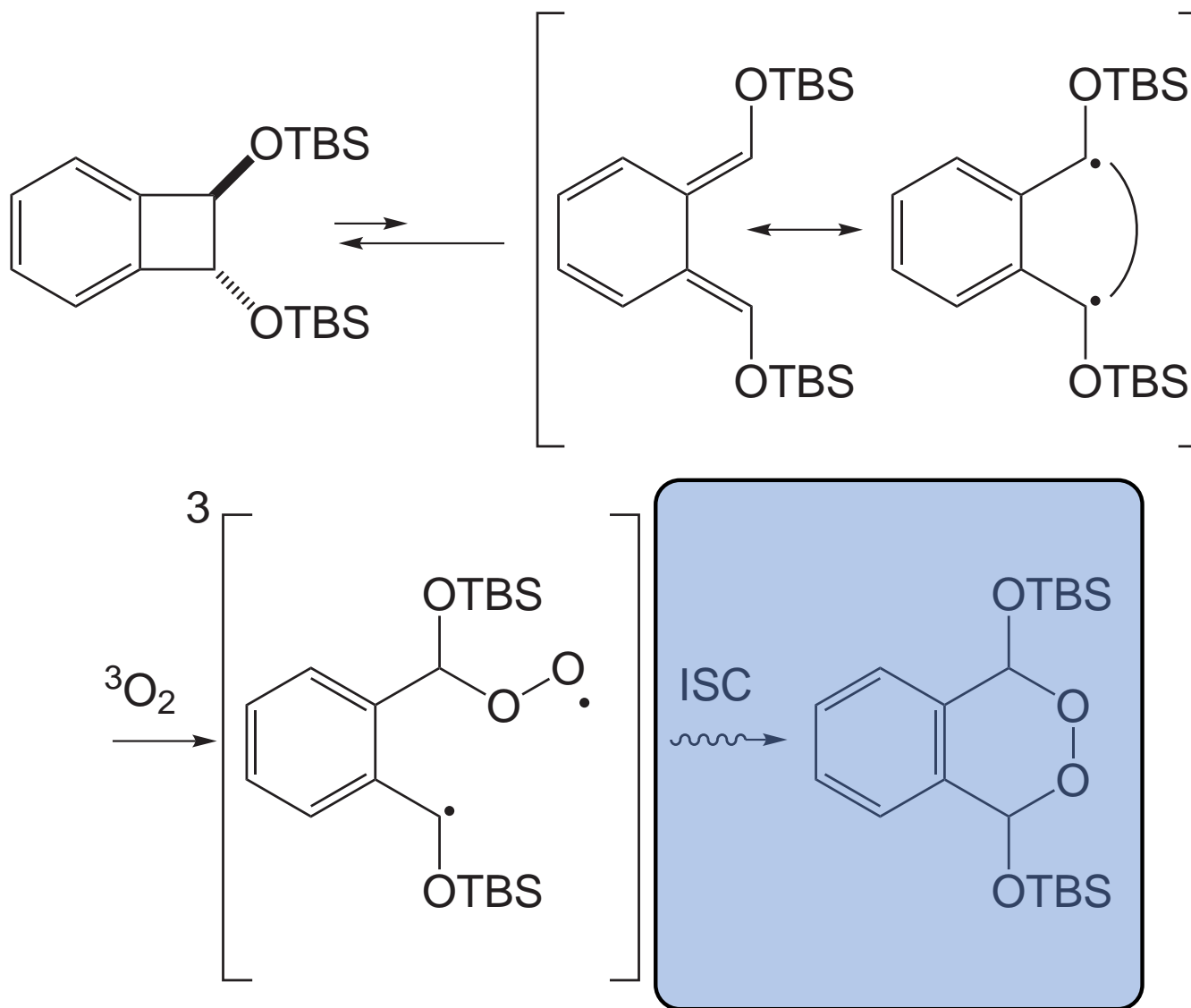

# ISC

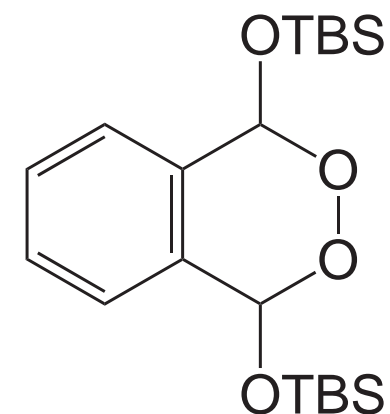
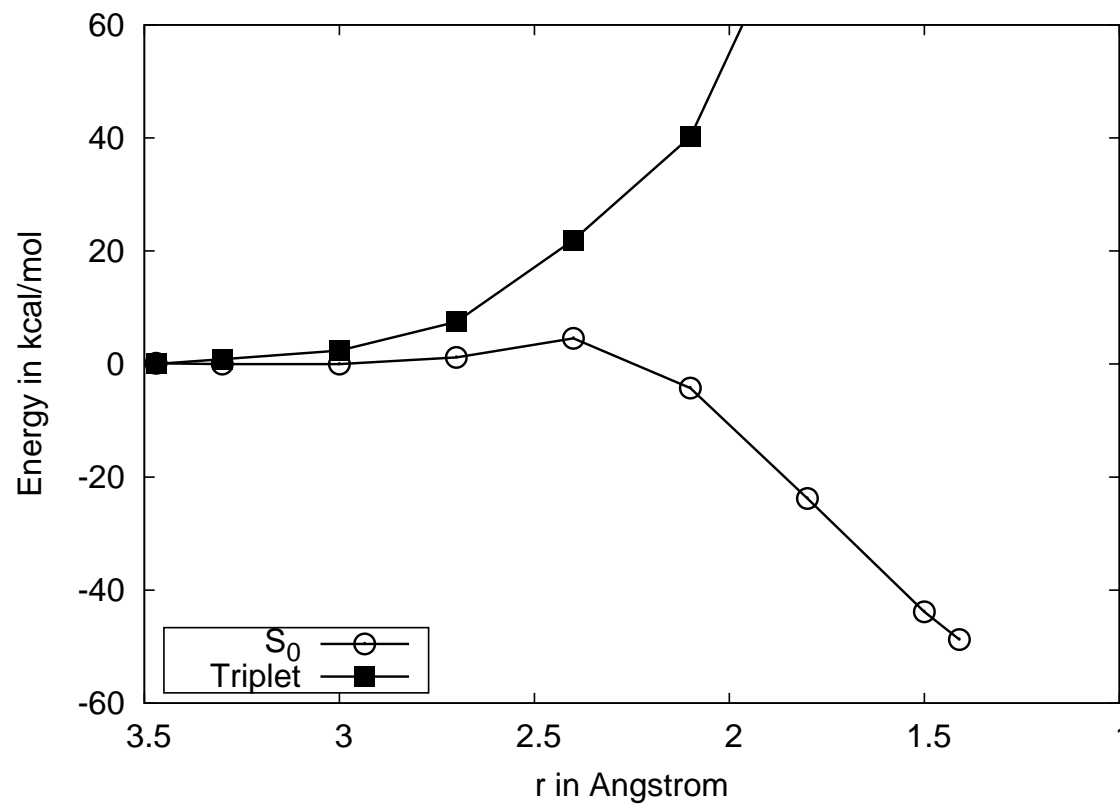
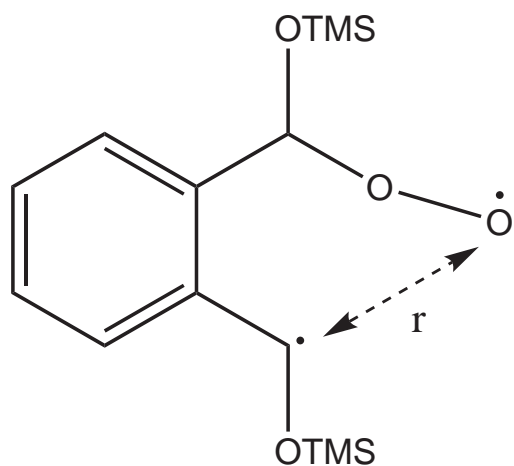

CAS(8,8) + CISD along the closing of C-O.

## Complete pathway

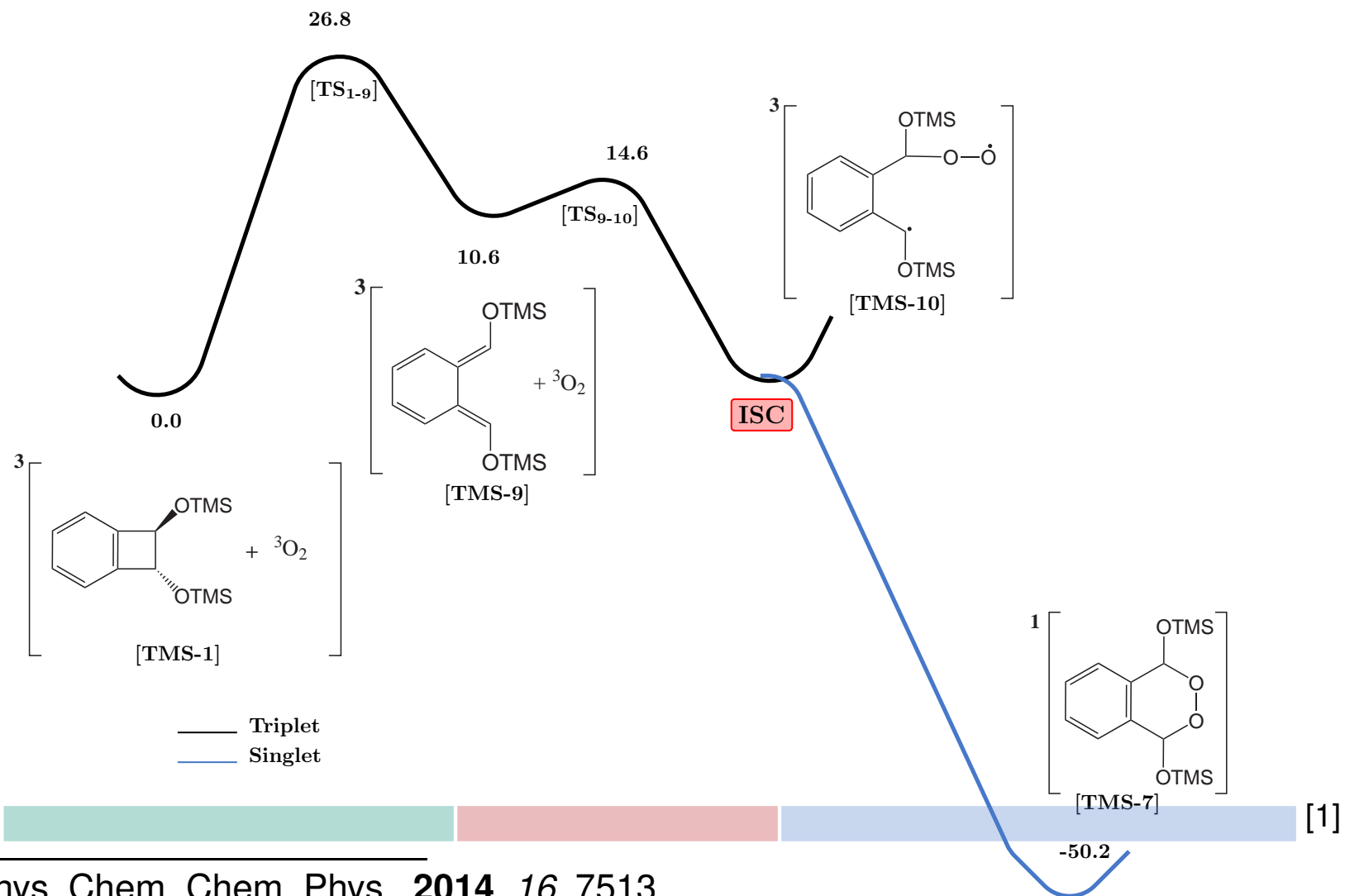

## Photoactivation

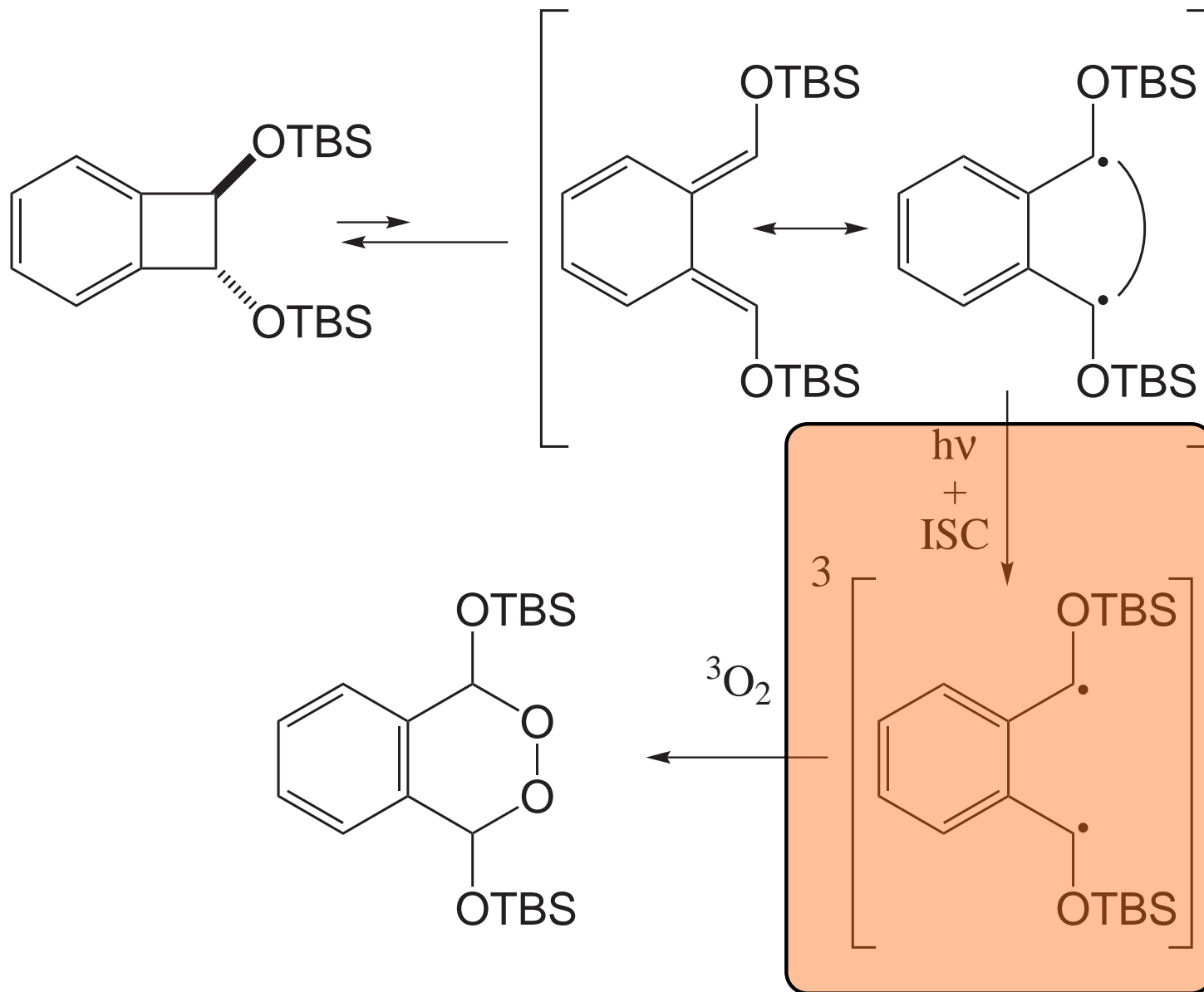

# Photoactivation

Theory

Experiment

Emission with excitation at 400nm

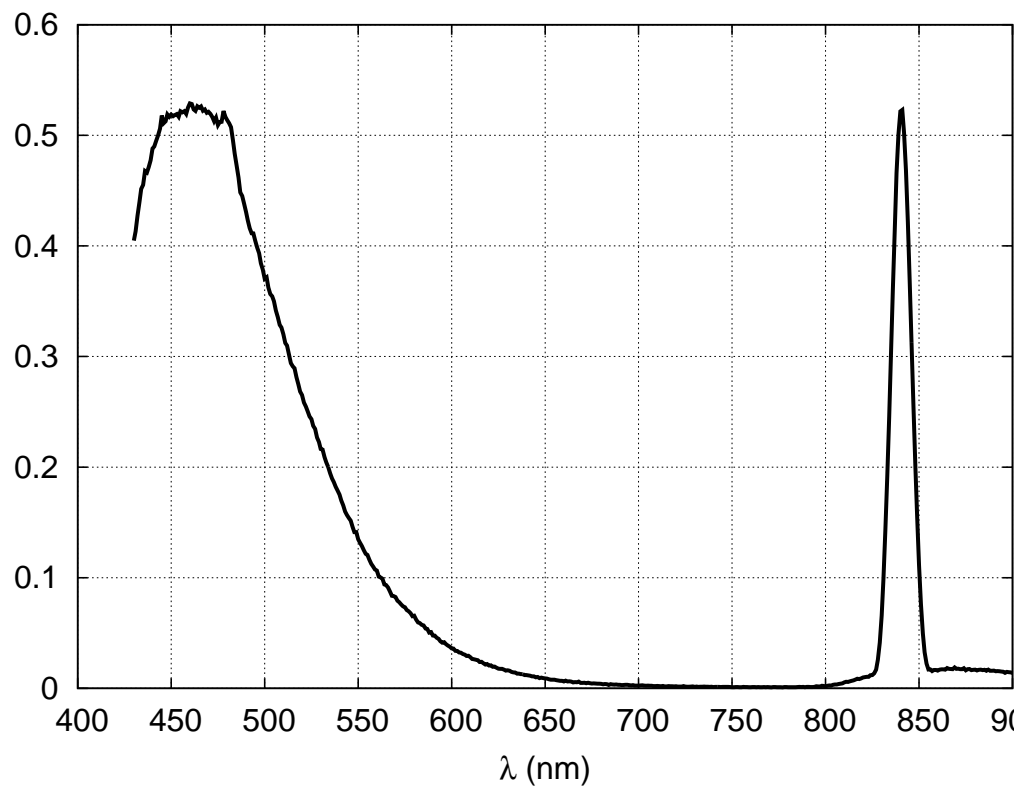
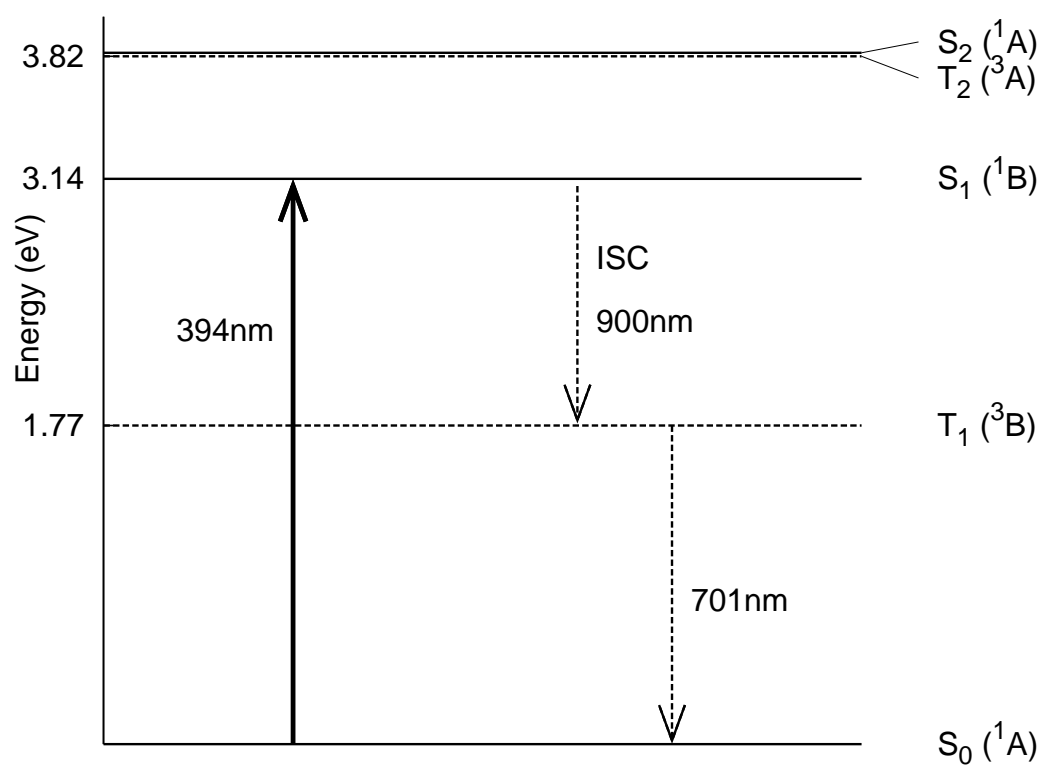

# Photoactivation

Theory

Experiment

Emission with excitation at 312nm

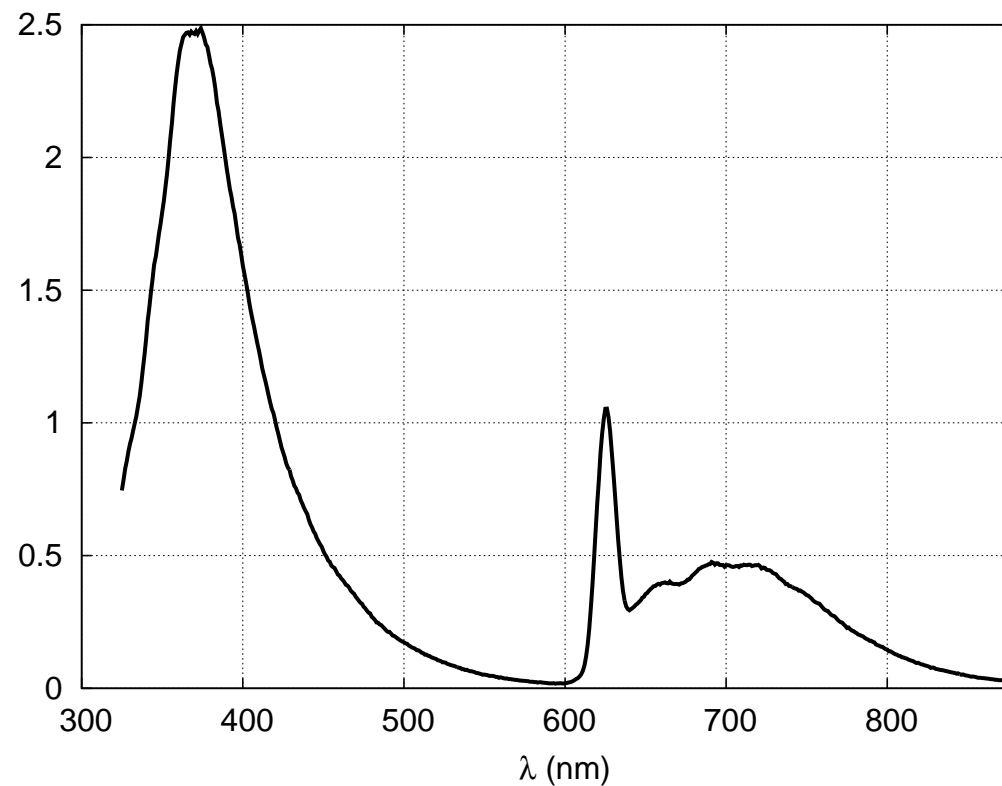
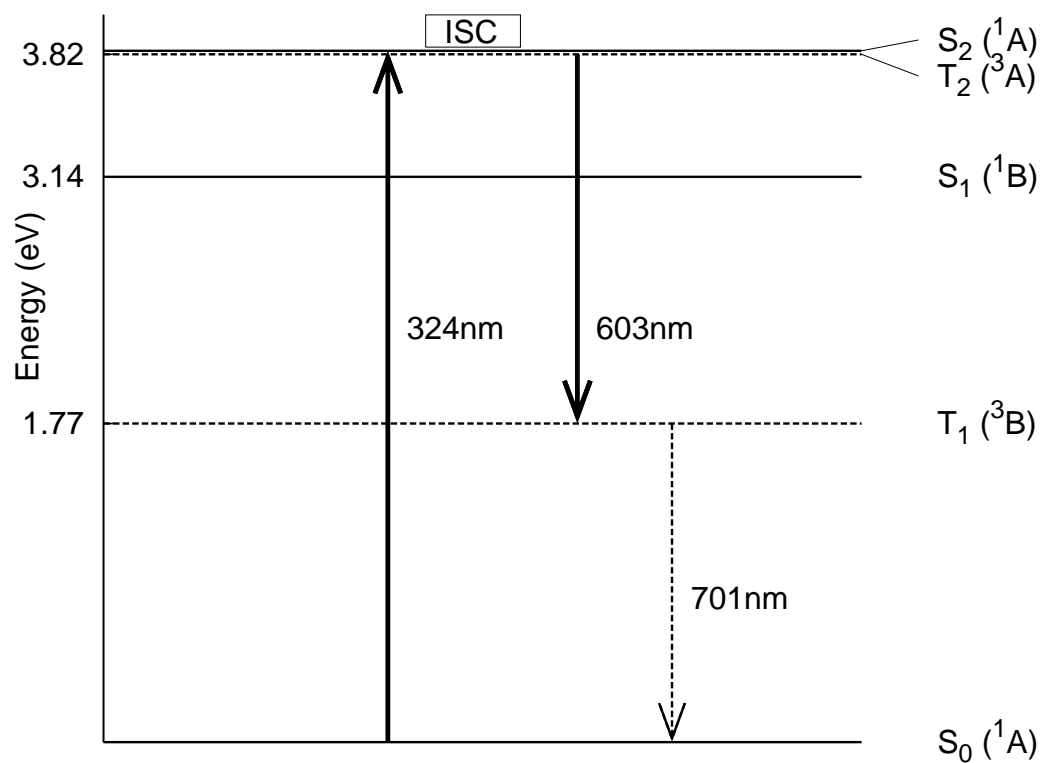



# Photoactivation

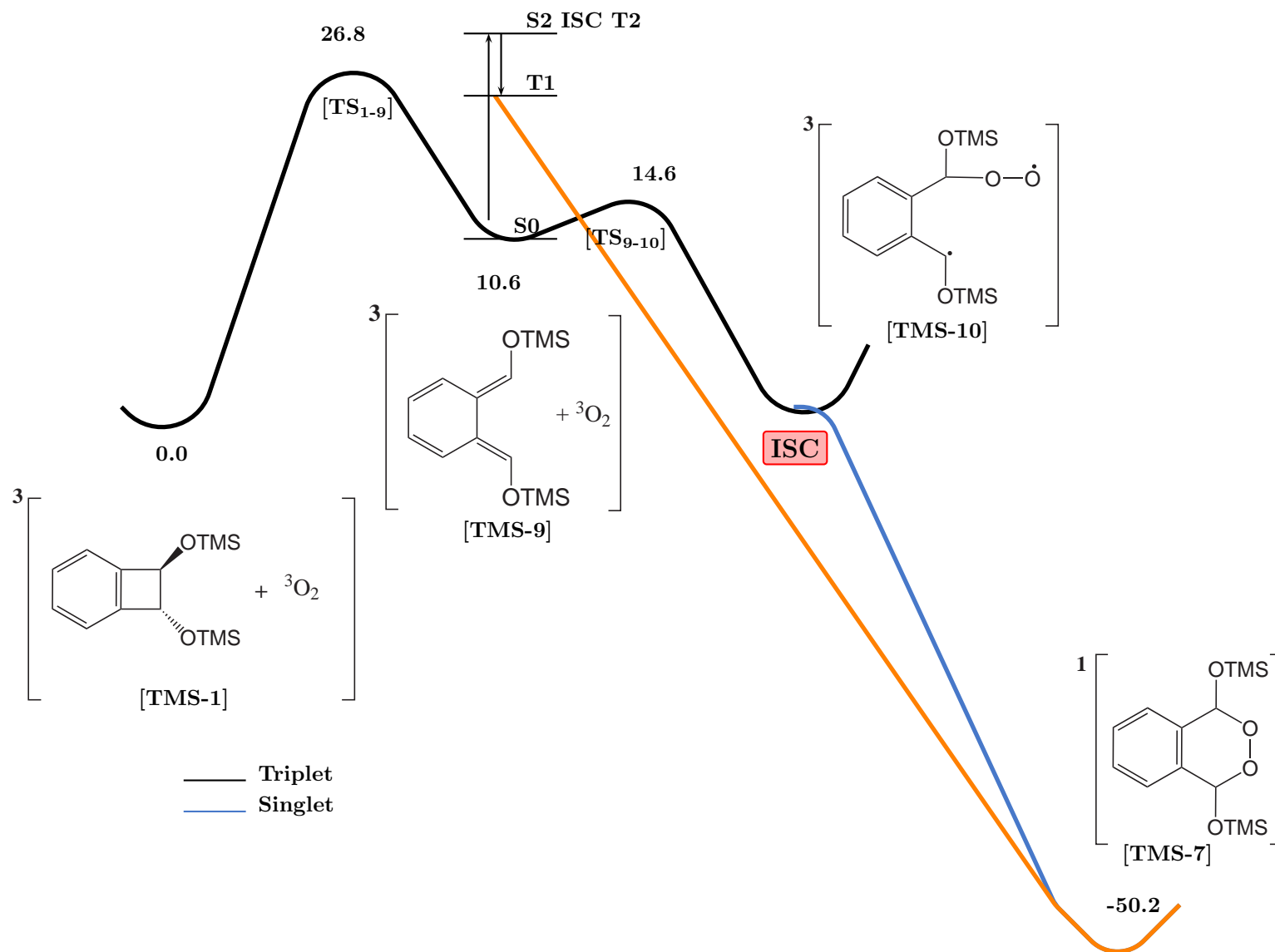

## Pseudopotentials for hybridized carbon atoms

## General aim

- A new model :
  - Treat explicitly electrons of interest only ( $\pi$ )
  - Replace part of a molecule by a simpler object
- Constraint :
  - Use any quantum chemistry package
  - Use any quantum chemistry method

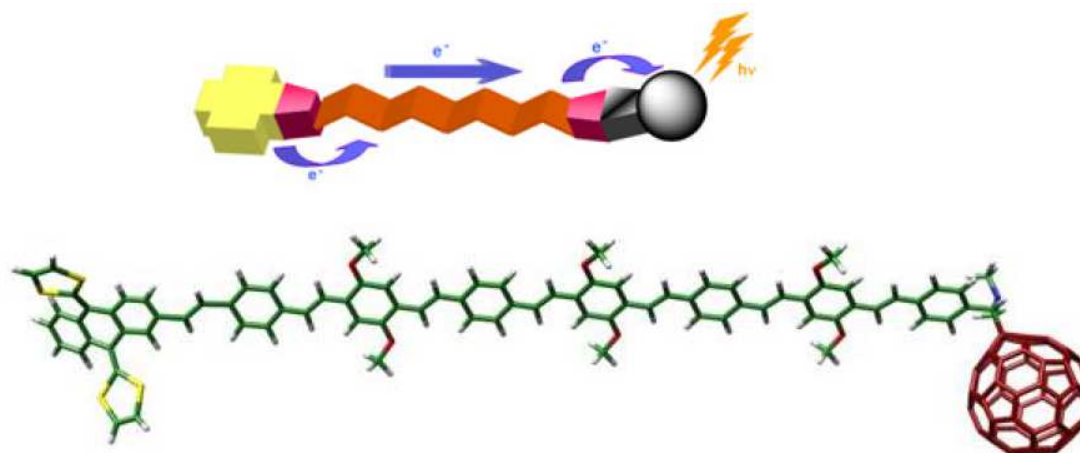

J. Am. Chem. Soc. 2009, 131, 12218-12229

## Atomic pseudopotentials

A non local atomic pseudopotential reads :

$$\hat{P} = a|\varphi\rangle\langle\varphi| \quad (1)$$

$$\text{with } \varphi = R(r)Y_m^l(\theta, \phi) \quad (2)$$

$\hat{P}$  is a shift operator on orbital  $\varphi$  : it modifies  $\epsilon_\varphi$ .

$R(r)$  is usually a gaussian function  $\exp(-\alpha r^2)$ .

$Y_m^l$  defines the angular momentum influenced by the potential.

## Atomic pseudopotentials : Perturbation analysis

$$\hat{F}^{(0)} \Phi_n^{(0)} = \epsilon_n^{(0)} \Phi_n^{(0)} \quad (3)$$

$$\hat{F} = \hat{F}^{(0)} + a|\varphi\rangle\langle\varphi| \quad (4)$$

$$\epsilon_n = \underbrace{\langle\Phi_n^{(0)}|\hat{F}^{(0)}|\Phi_n^{(0)}\rangle}_{\epsilon_n^{(0)}} + \underbrace{\langle\Phi_n^{(0)}|a|\varphi\rangle\langle\varphi|\Phi_n^{(0)}\rangle}_{\Delta\epsilon_n} \quad (5)$$

$$\Delta\epsilon_n = a\langle\varphi|\Phi_n^{(0)}\rangle^2 \quad (6)$$

Two parameters to modify the original orbitals :

1.  $a$  (eigenvalue)
2. shape of  $\varphi$  (angular momentum and spatial extent)

## From atomic to molecular shaped pseudopotentials

We aim at treating the  $\pi$  electrons *only*. For carbon atoms :

- 1 electron in 1  $p_z$  atomic orbital ;
- effective atomic charge  $Z=1$ .

Ring a bell ?

—————→ Complexity



Hückel

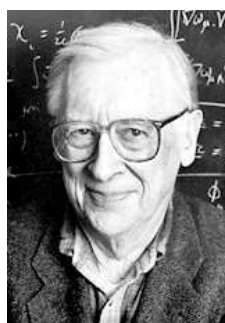

PPP

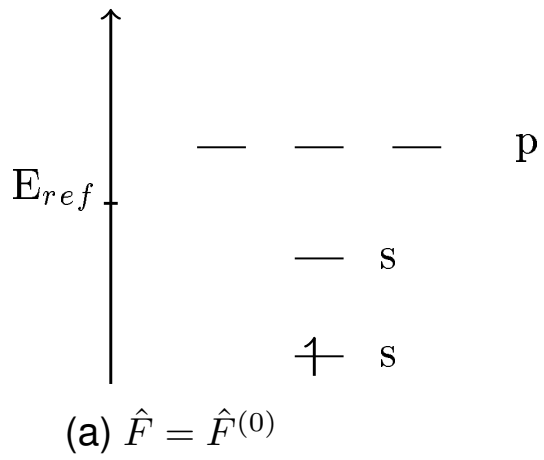
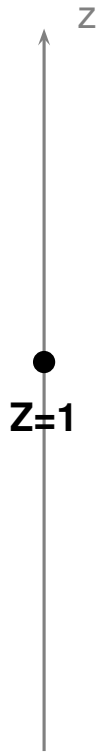

(a)  $\hat{F} = \hat{F}^{(0)}$

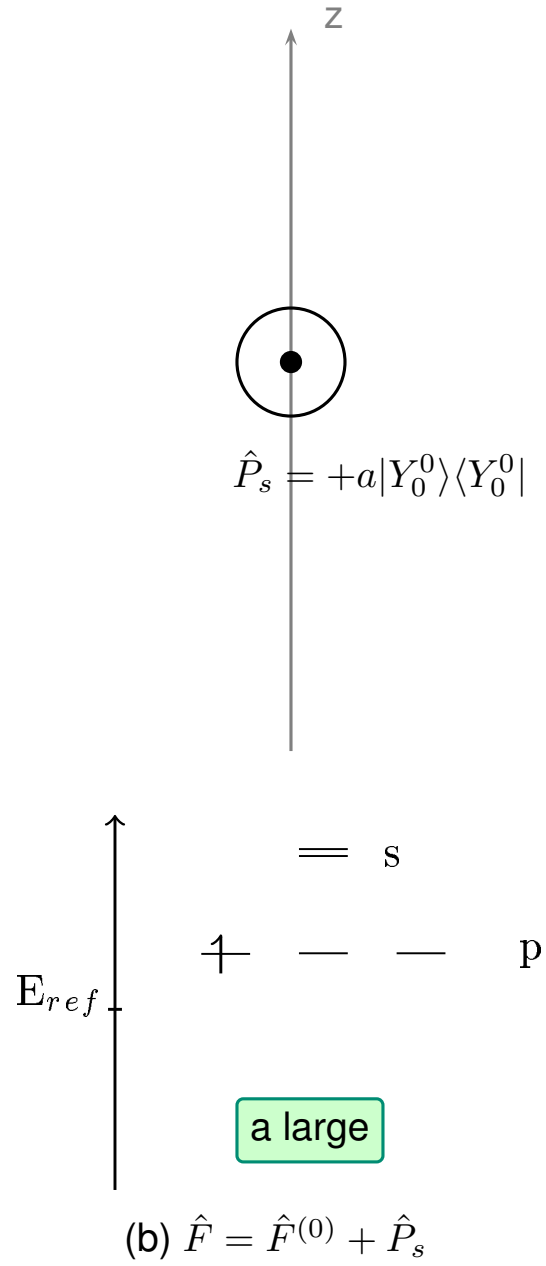
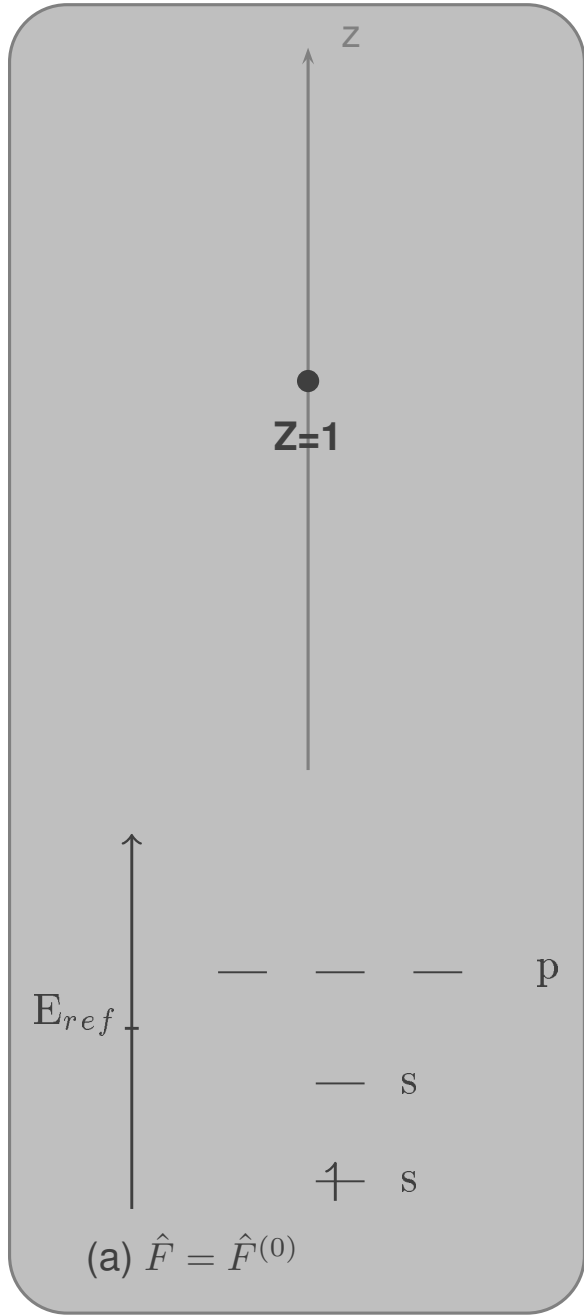



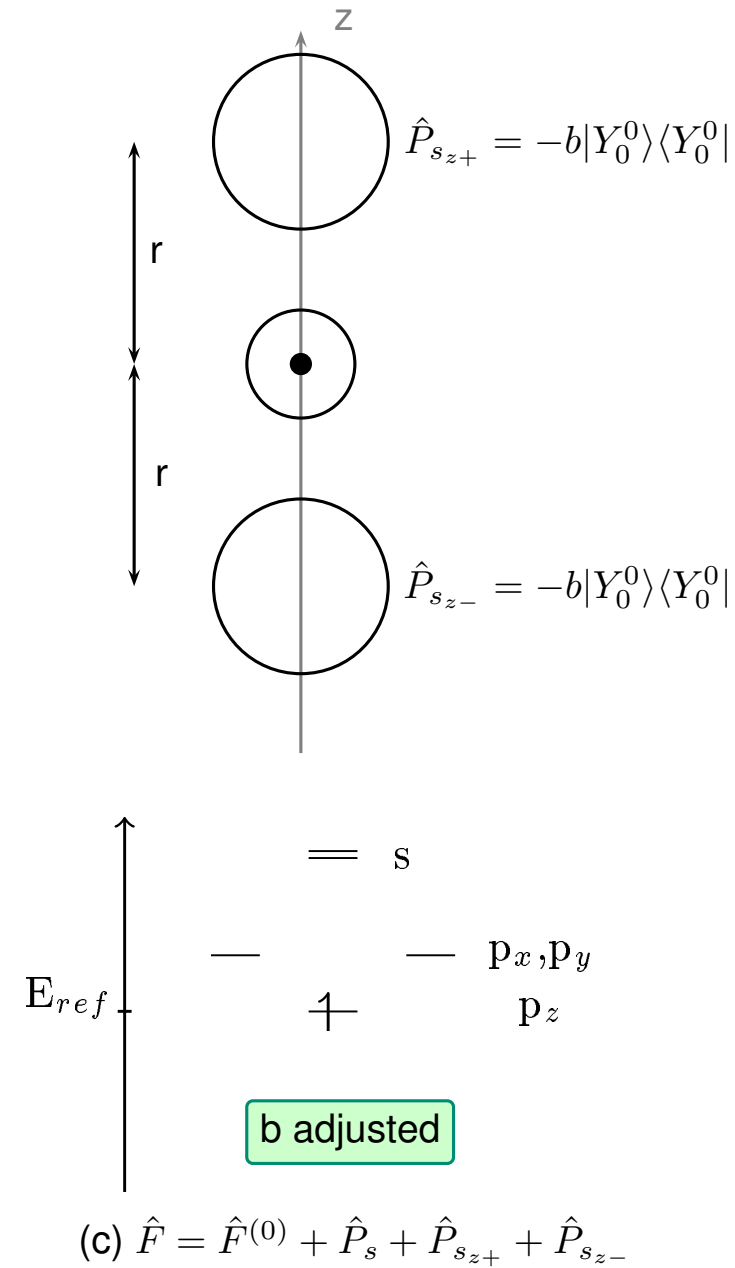
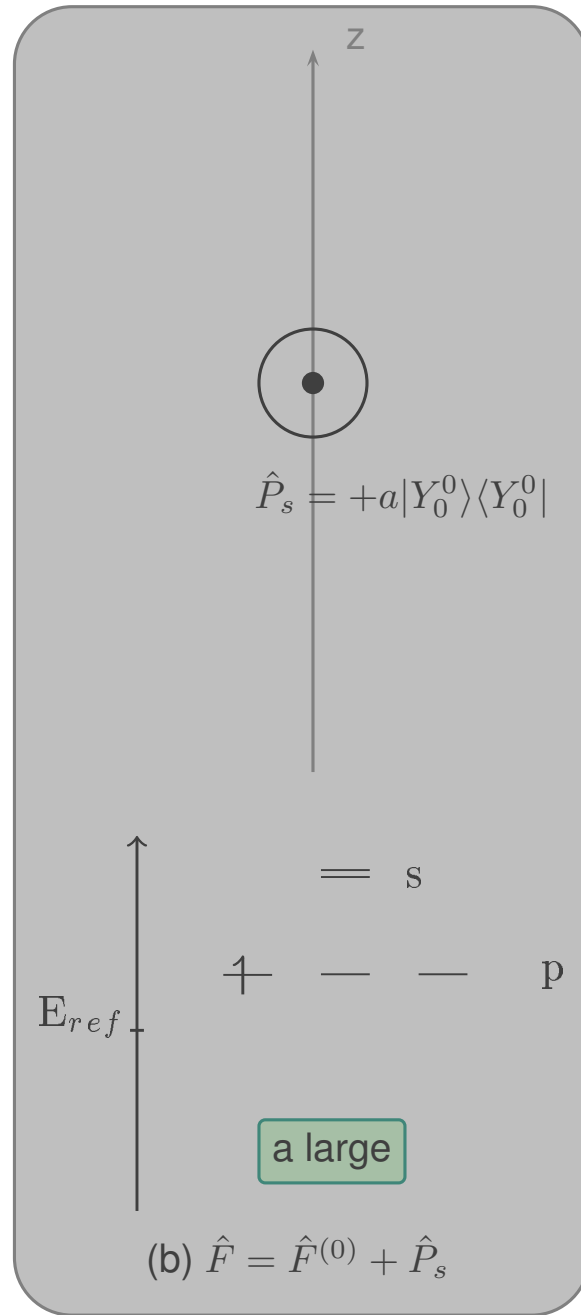
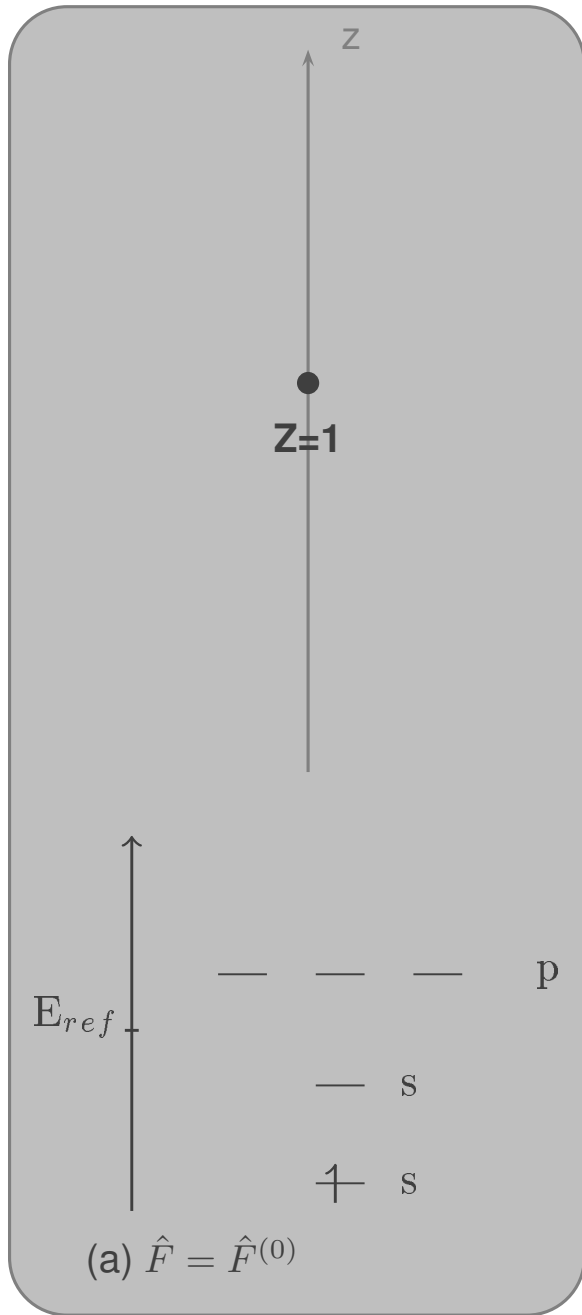

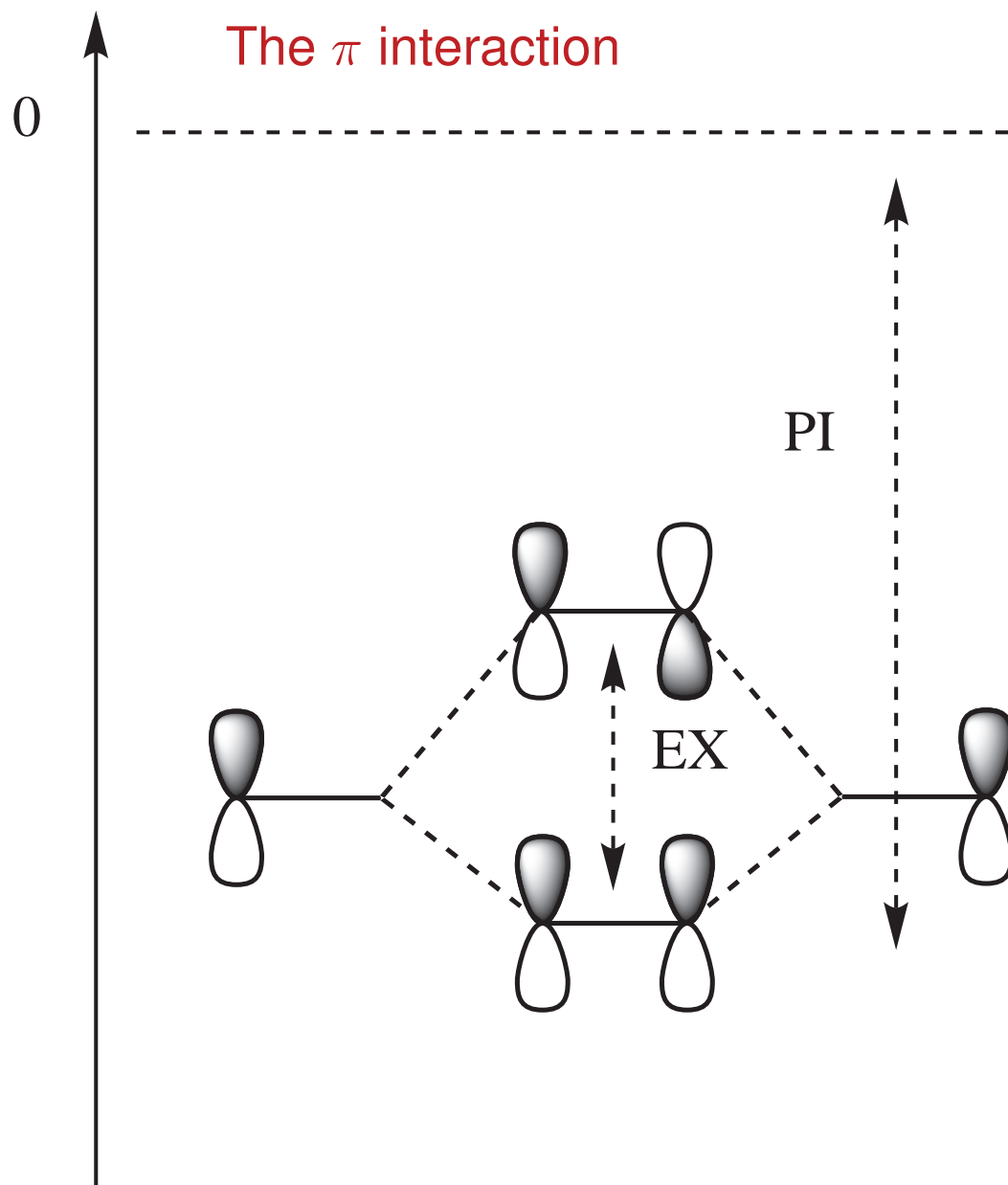

- Shape of orbitals OK
- Excitation energy WRONG
- Ionization potential WRONG

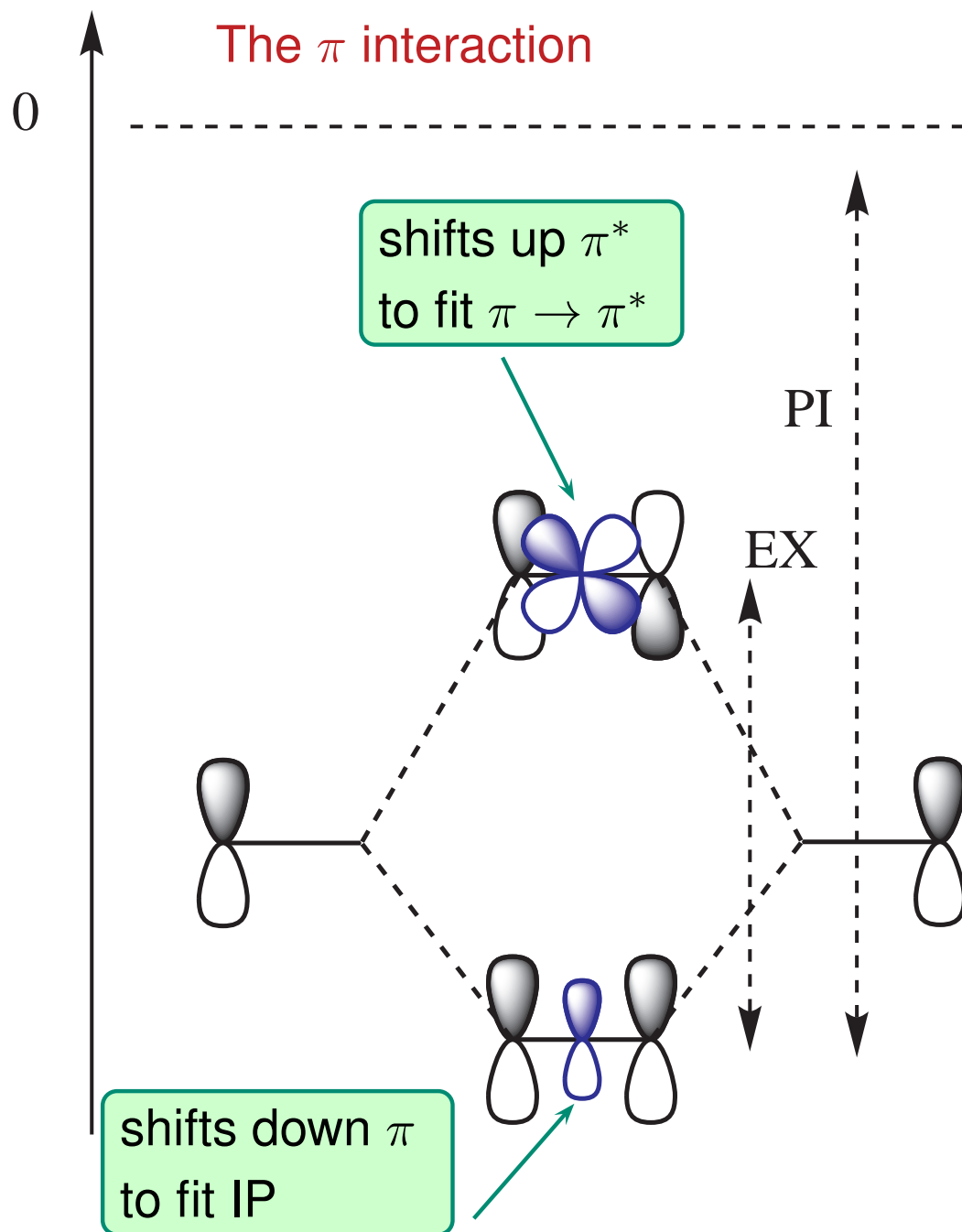

- Shape of orbitals OK
- Excitation energy OK
- Ionization potential OK

## Combination of CC bonds : all trans even polyenes

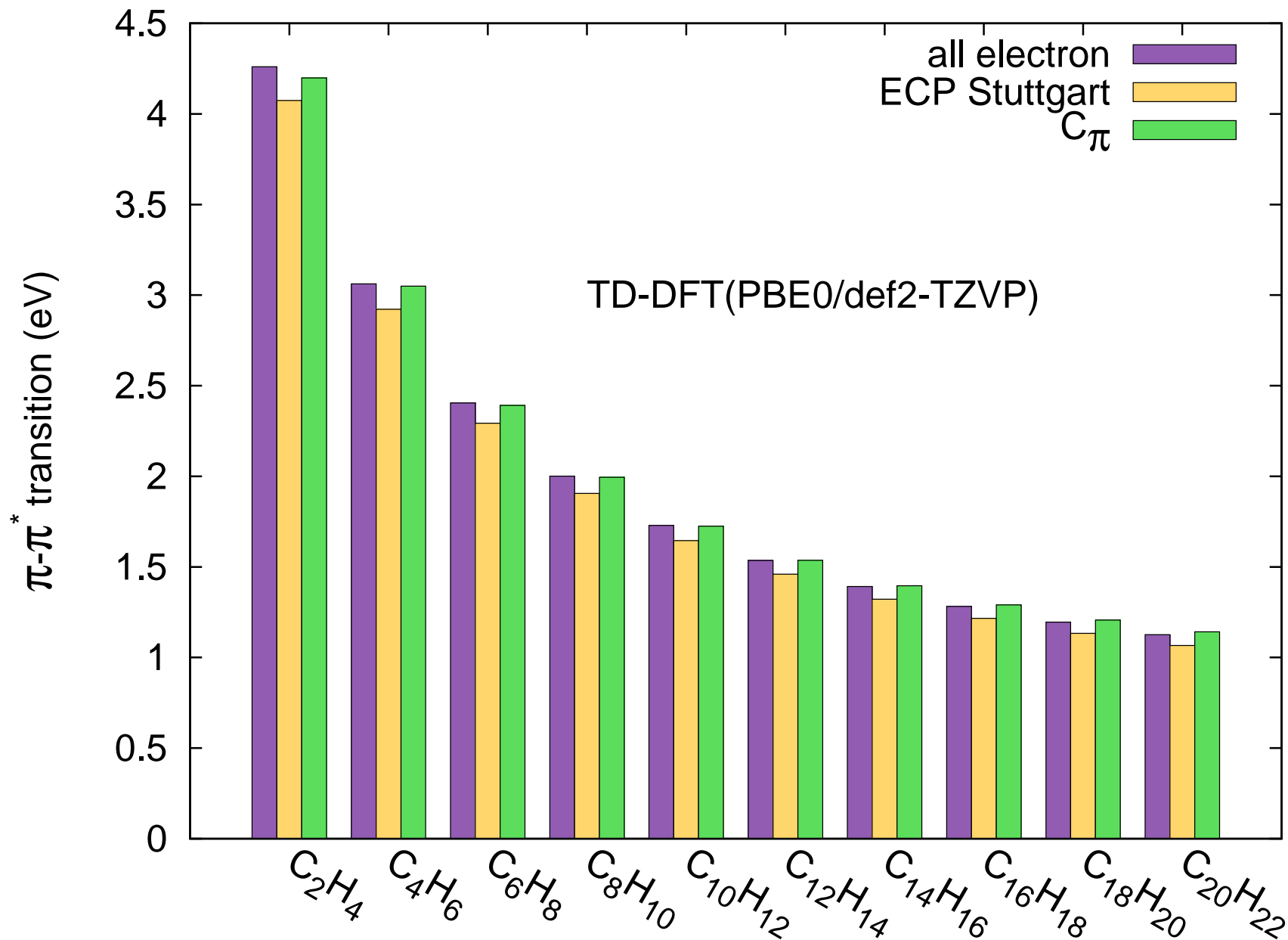

## Fused rings

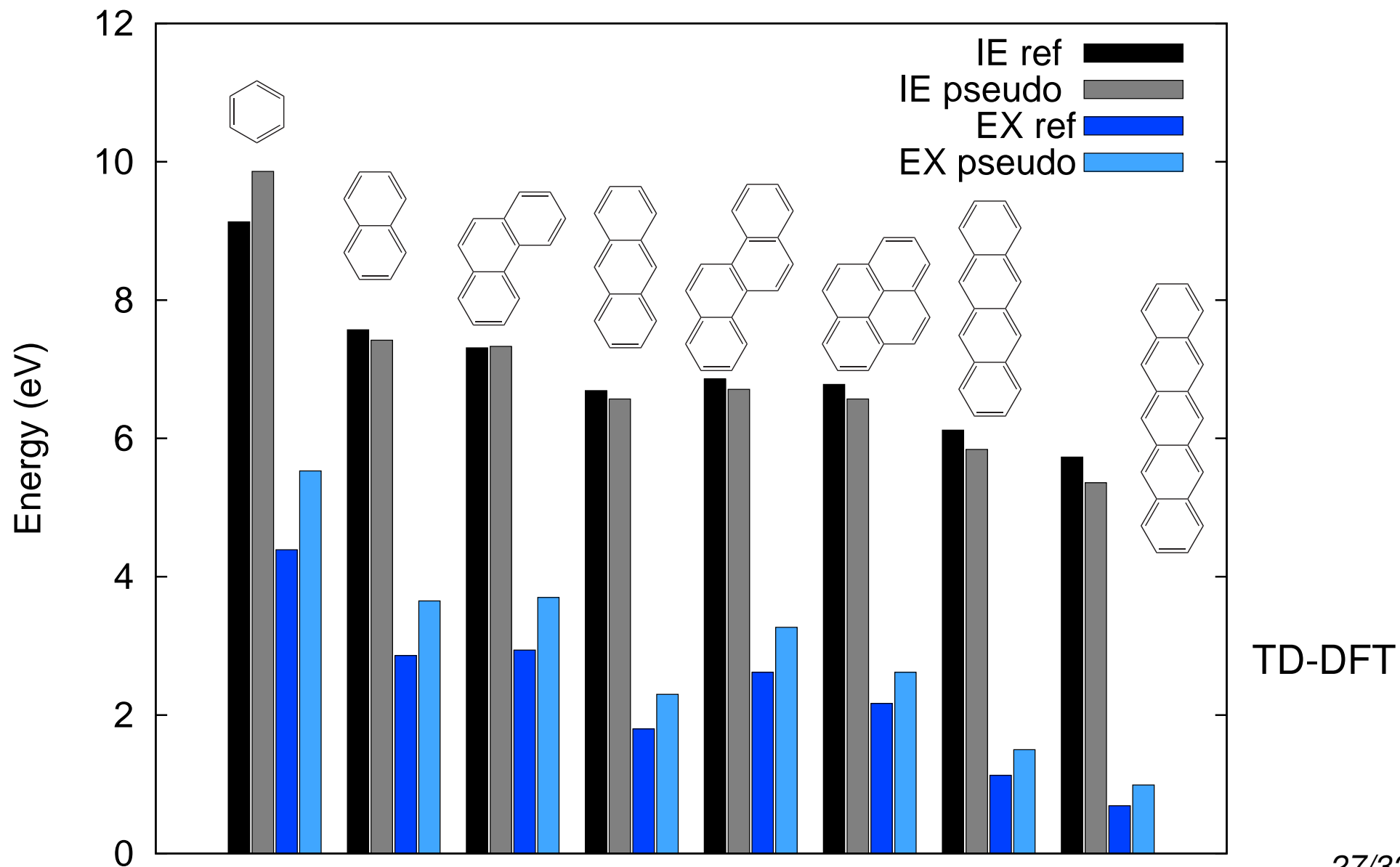

$\sigma$  bond

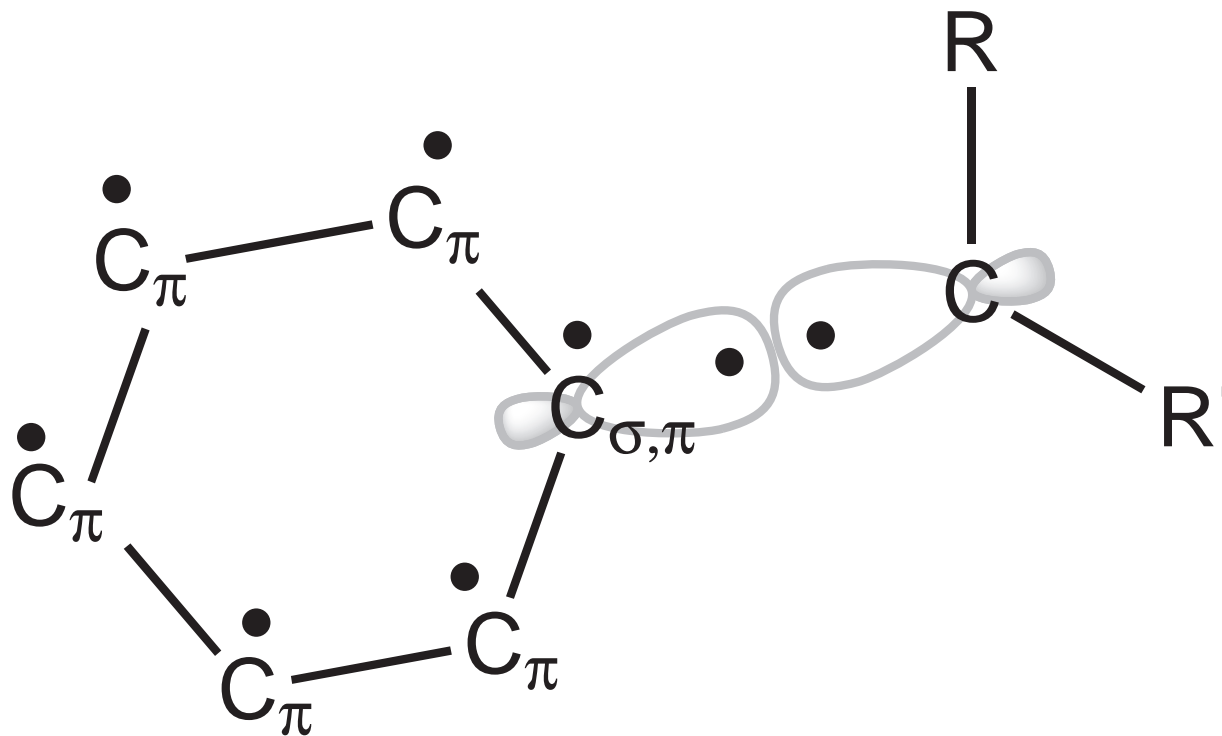

Extraction of  $C_{\sigma,\pi}$  :

- $Z=2$
- 1 electron in  $p_z$  and 1 electron in  $sp$

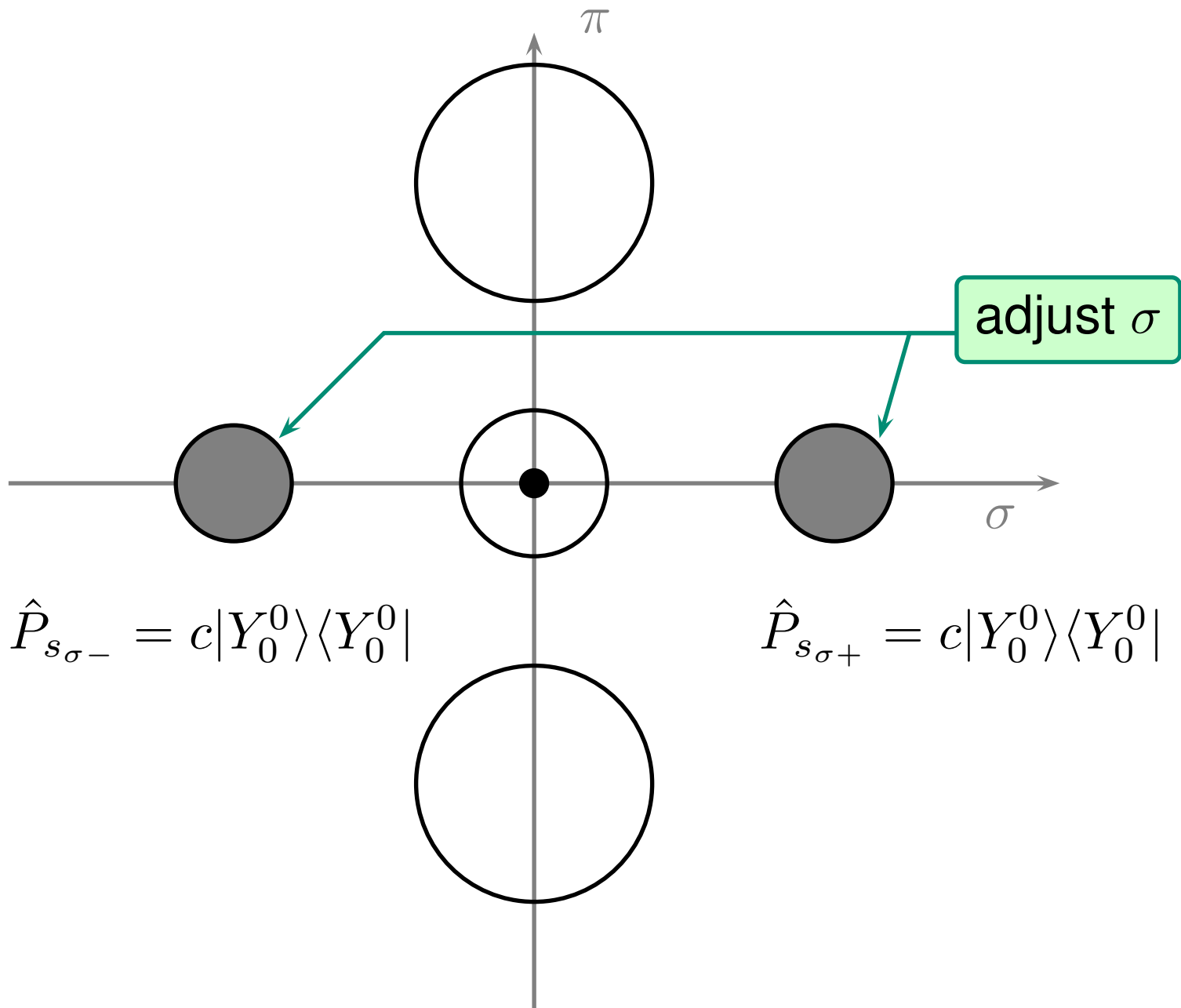

## Bonding to an active part

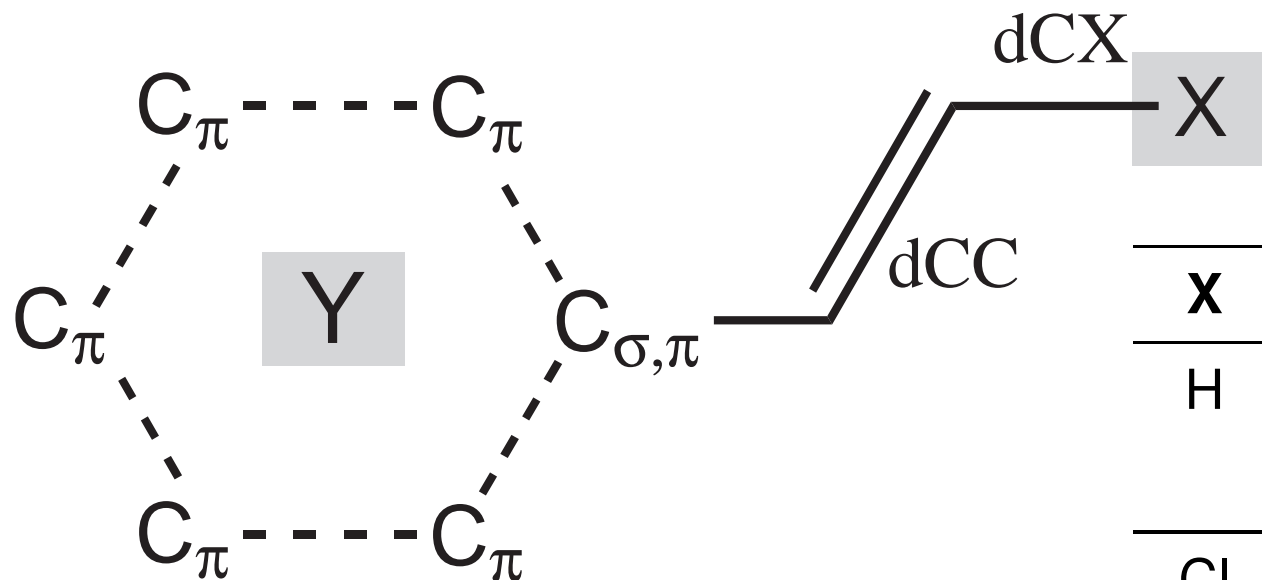

X	Y	dCC	dCX
H	$C_6H_5$	133.1	107.2
	$(C)_5C_{\sigma,\pi}$	132.0	107.3
Cl	$C_6H_5$	132.2	180.7
	$(C)_5C_{\sigma,\pi}$	131.6	181.1
Br	$C_6H_5$	132.4	193.2
	$(C)_5C_{\sigma,\pi}$	131.7	193.5
Me	$C_6H_5$	133.2	150.9
	$(C)_5C_{\sigma,\pi}$	132.4	151.1



## Conclusion

- We could create pseudopotentials for hybridized carbon atoms
- Use any QC package and any QC method
- Spectroscopy and geometry optimization
- Extension to other atoms with  $\pi$  electrons
- Other kind of hybridization tricky ( $\sigma$   $\pi$  orthogonality used)

## Merci

- UV analysis
  - Jalila Simaan
  - Bruno Faure
- Co-workers
  - Béatrice Tuccio
  - Laurent Commeiras
  - Jean-Luc Parrain
- iSm2
  - The logo for Aix\*Marseille université, featuring a blue curved line on the left, the text 'Aix\*Marseille' in black, and 'université' in blue below it.
- You for your attention