

***trans*-1,2-Disiloxybenzocyclobutene + O₂
&
pseudopotentials for hybridized carbon atoms**

***trans*-1,2-Disiloxybenzocyclobutene + O₂**

Secondary reaction in lactonamycinone synthesis

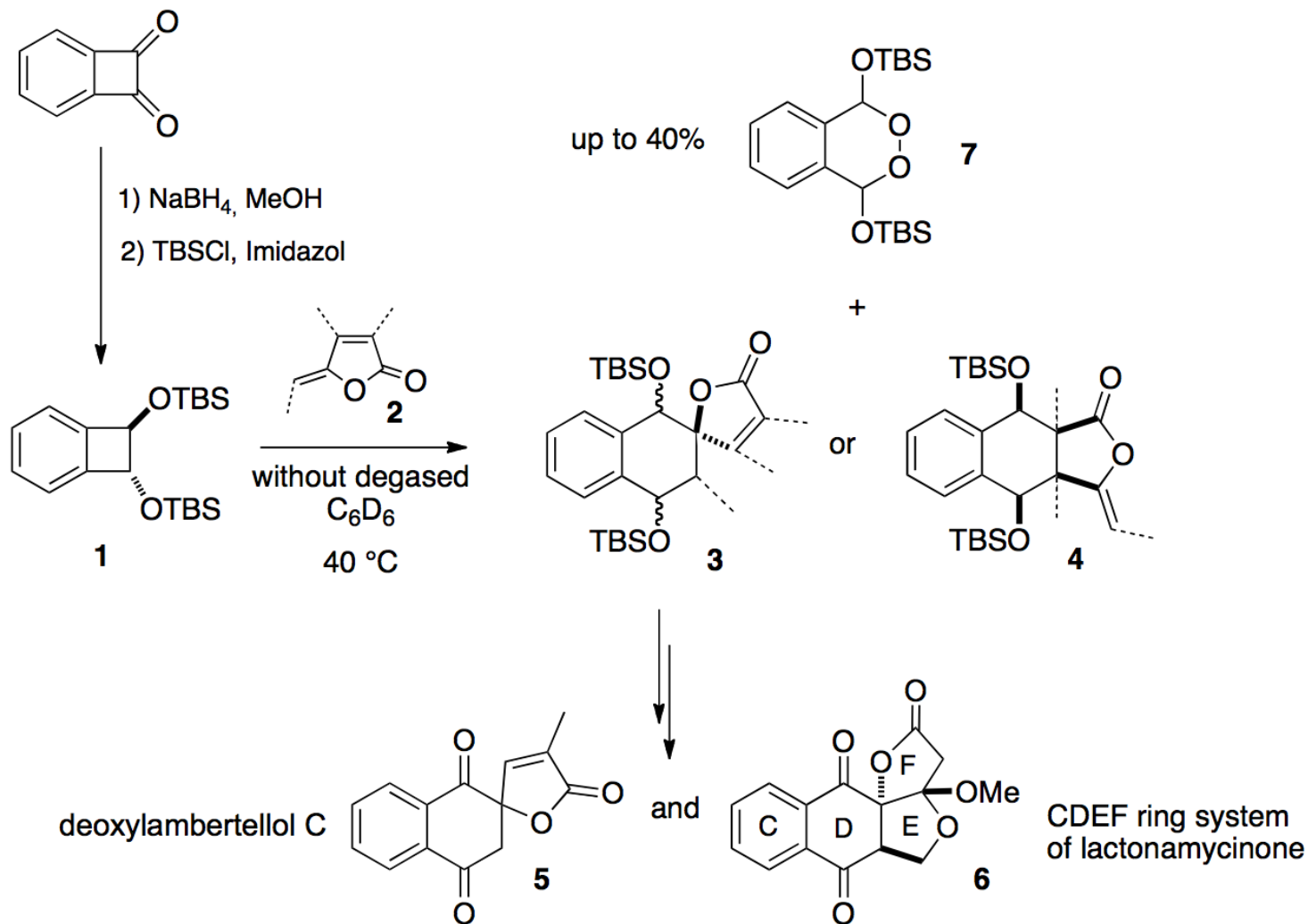
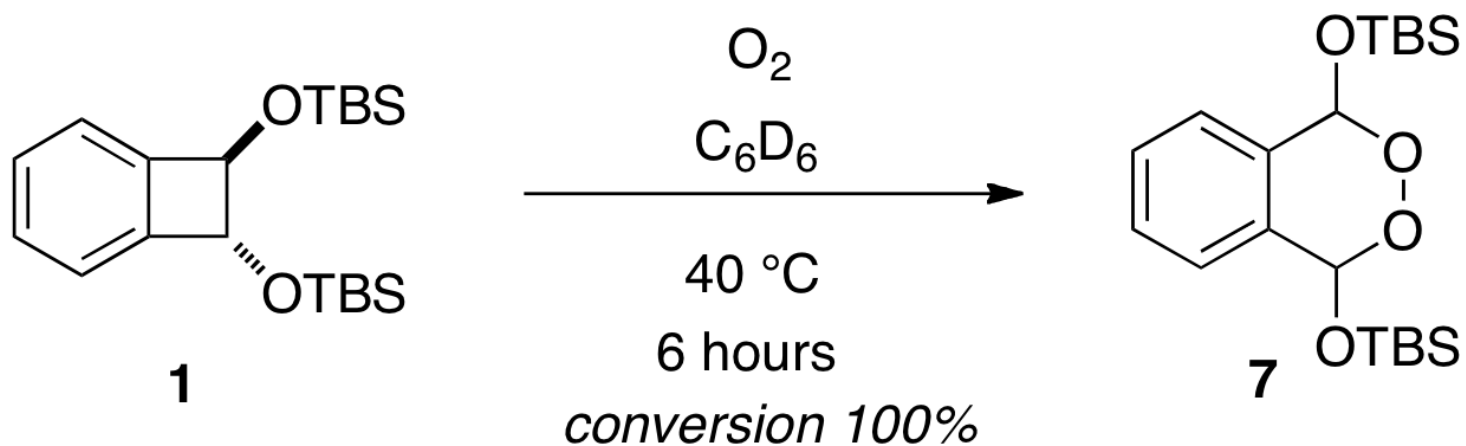

Reaction with O₂

With benzocyclobutene same reaction at 190-240 °C. ^[1]

[1]. W. R. Roth, T. Ebbrecht, A. Breitat *Chem.Ber.* **1988** *121*, 1357-1358

Suggested pathway

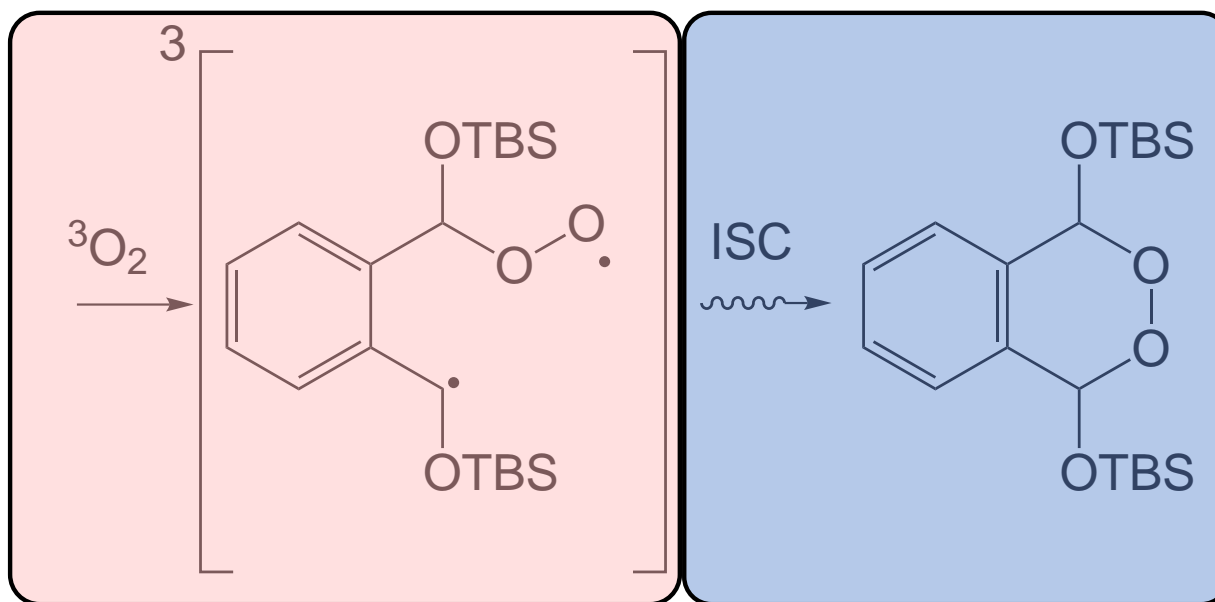
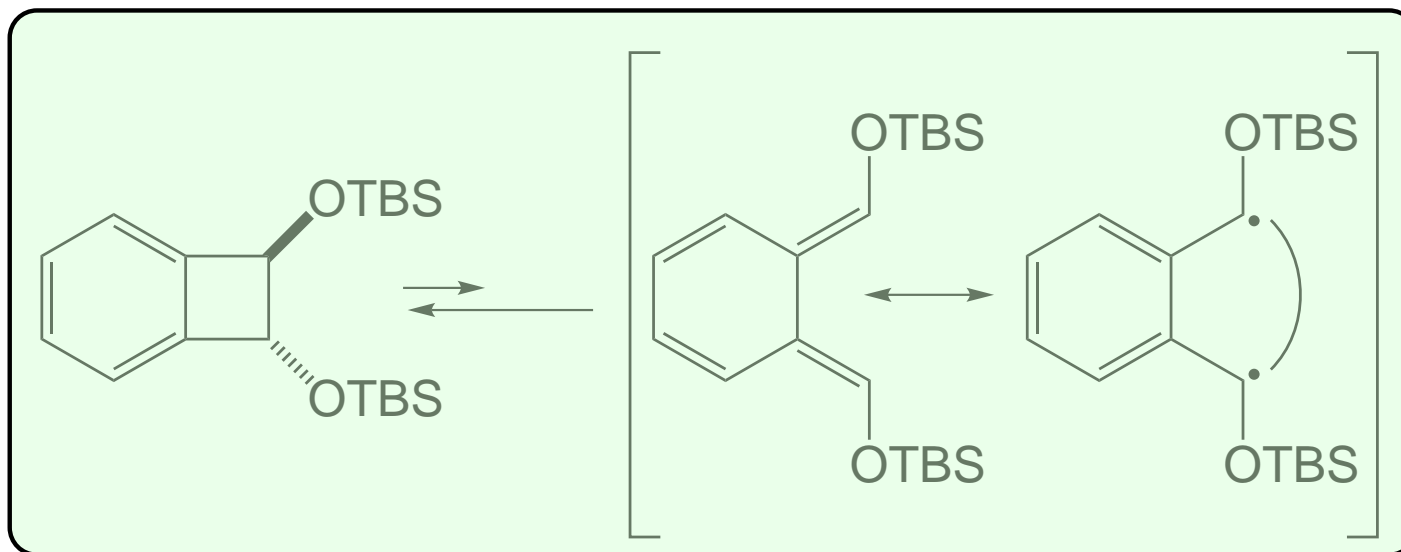

Theory : opening and color



-20 °C



T amb.

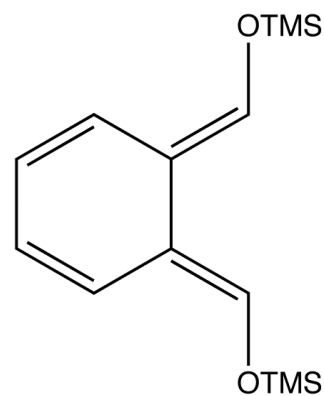
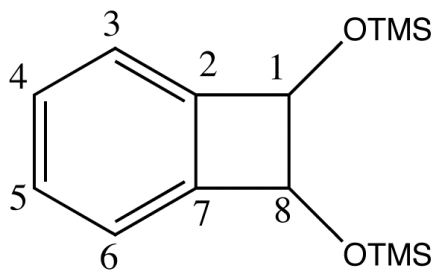

Ground and first excited state :

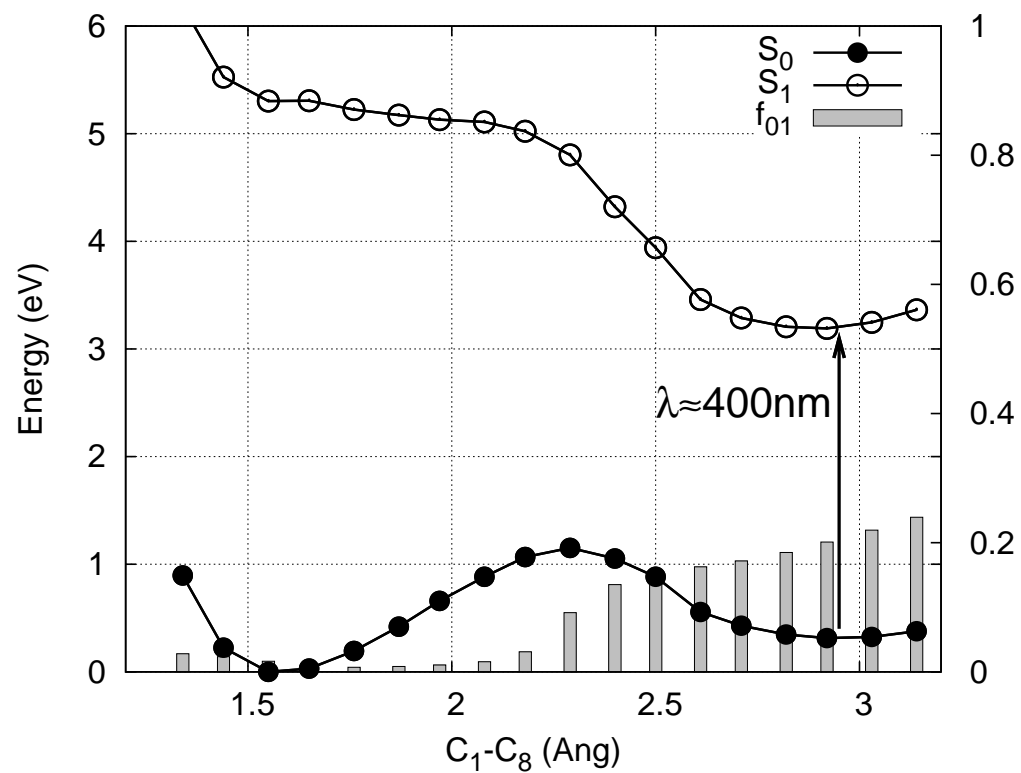

Absorbs blue : appears yellow

Exp : UV analysis

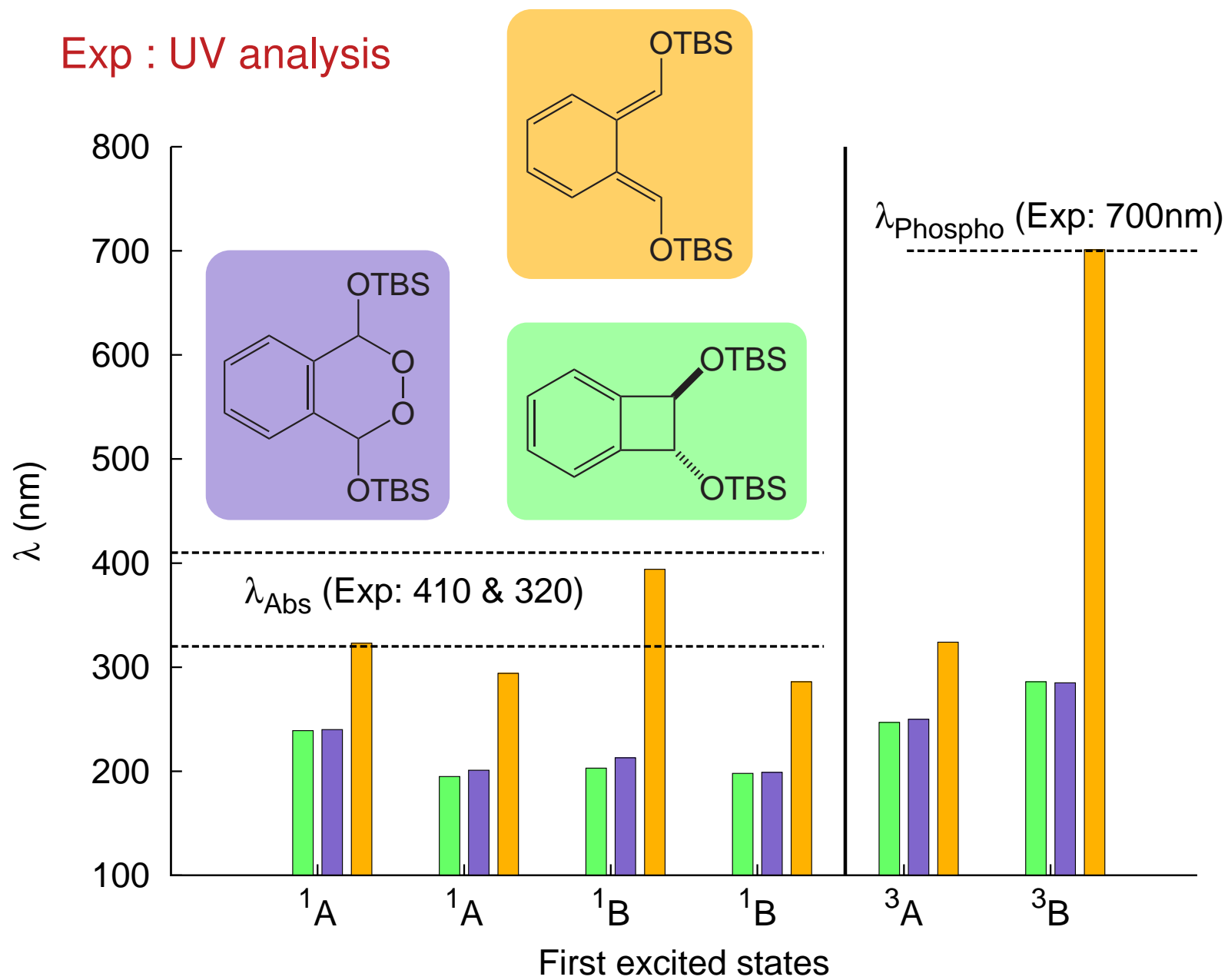

Suggested pathway

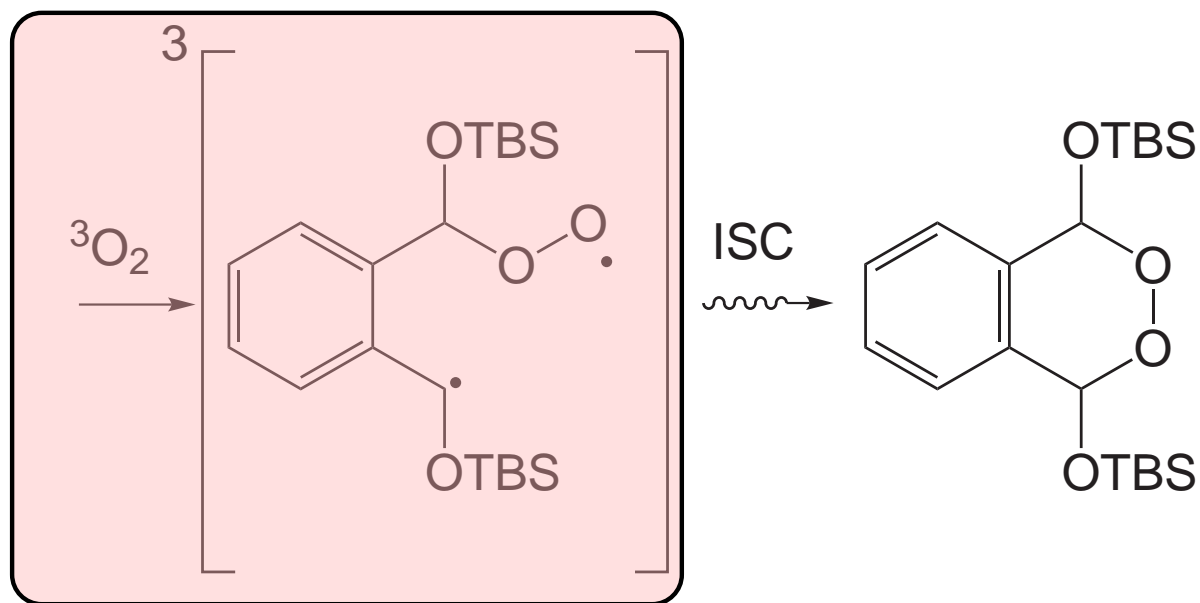
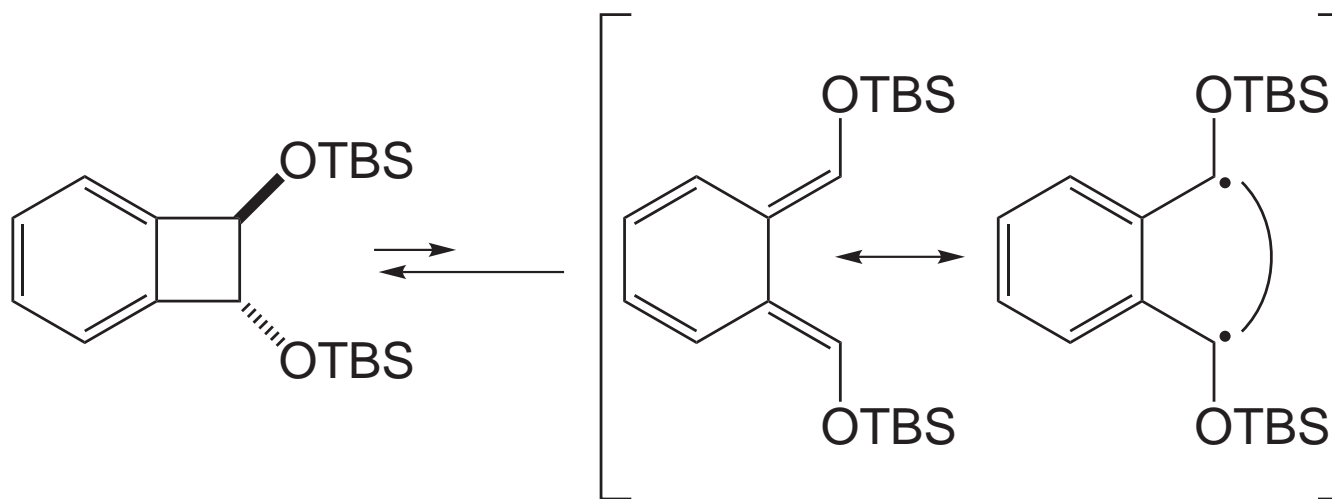

Intermediate exists

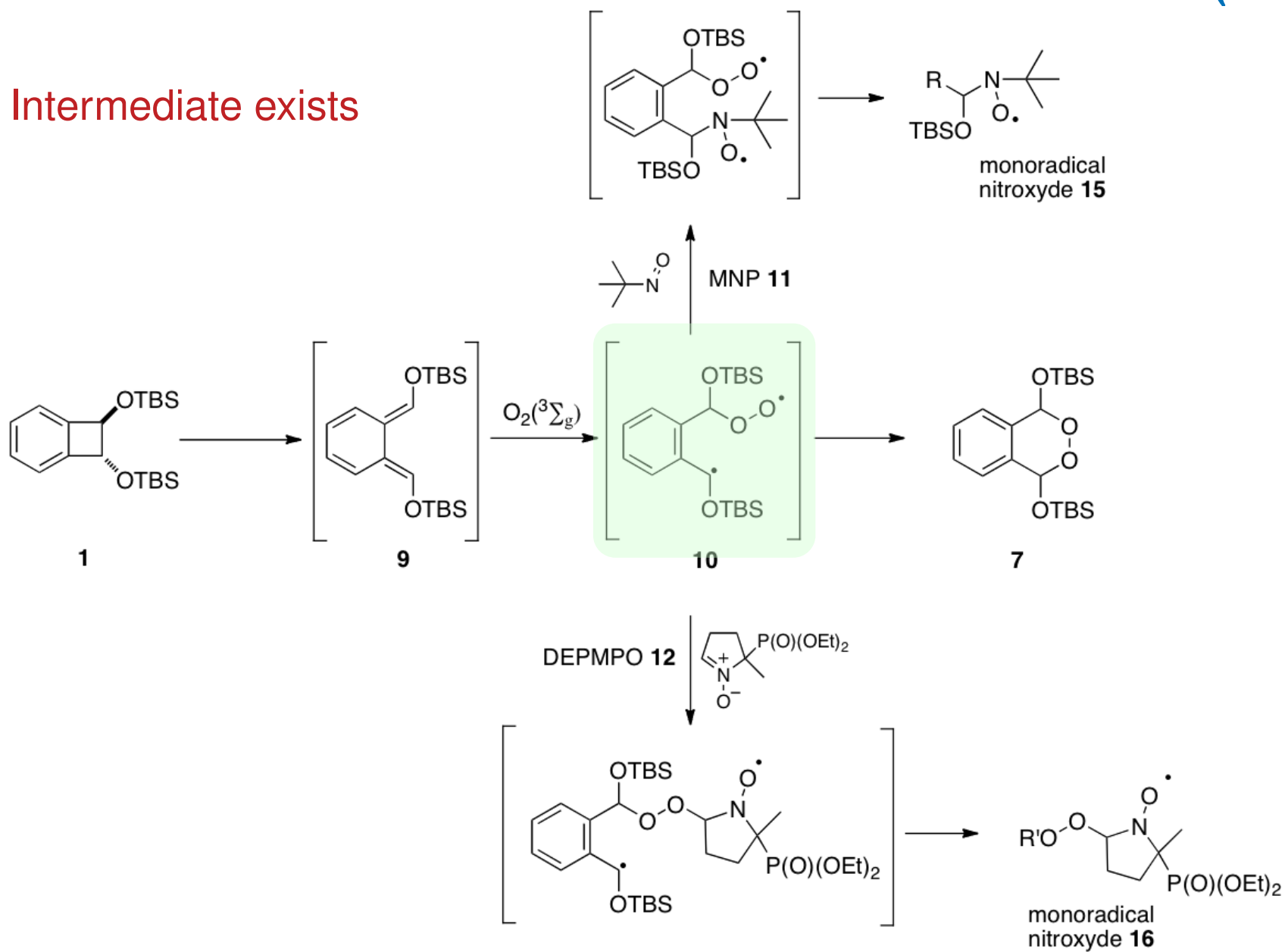

Intermediate : proof of existence

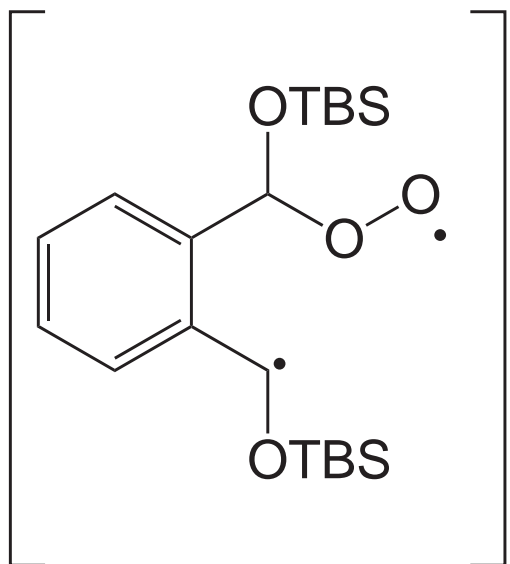

Energy	kJ/mol	cm ⁻¹
singlet	0.35	30
triplet	0	0

Transition state of O₂ approach at 15kcal/mol.

Spin trapping : the two radical centers are characterized.

Theory : Singlet and triplet states are quasi degenerated.

Suggested pathway

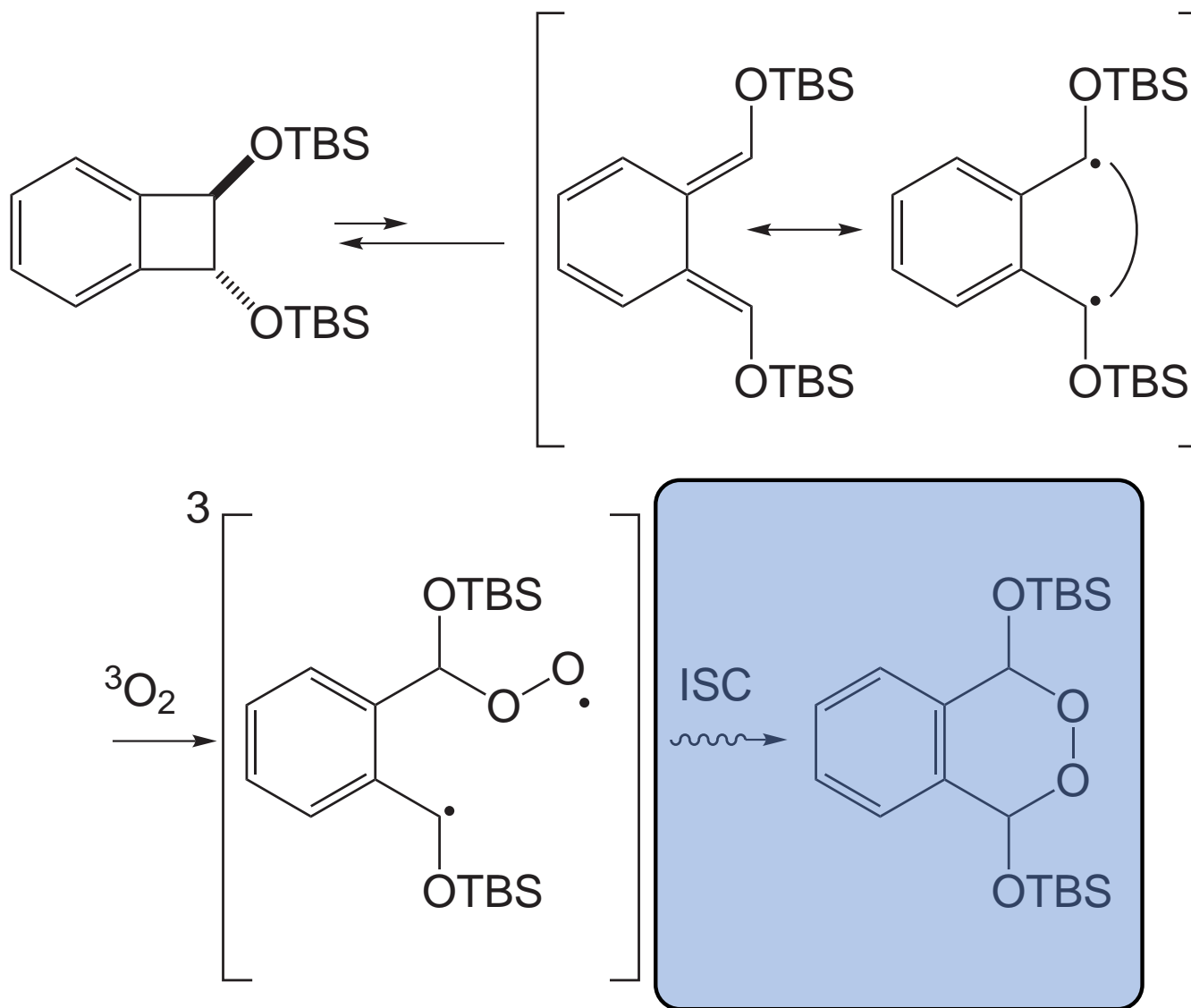

ISC

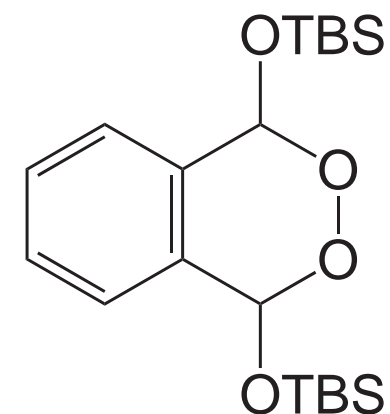
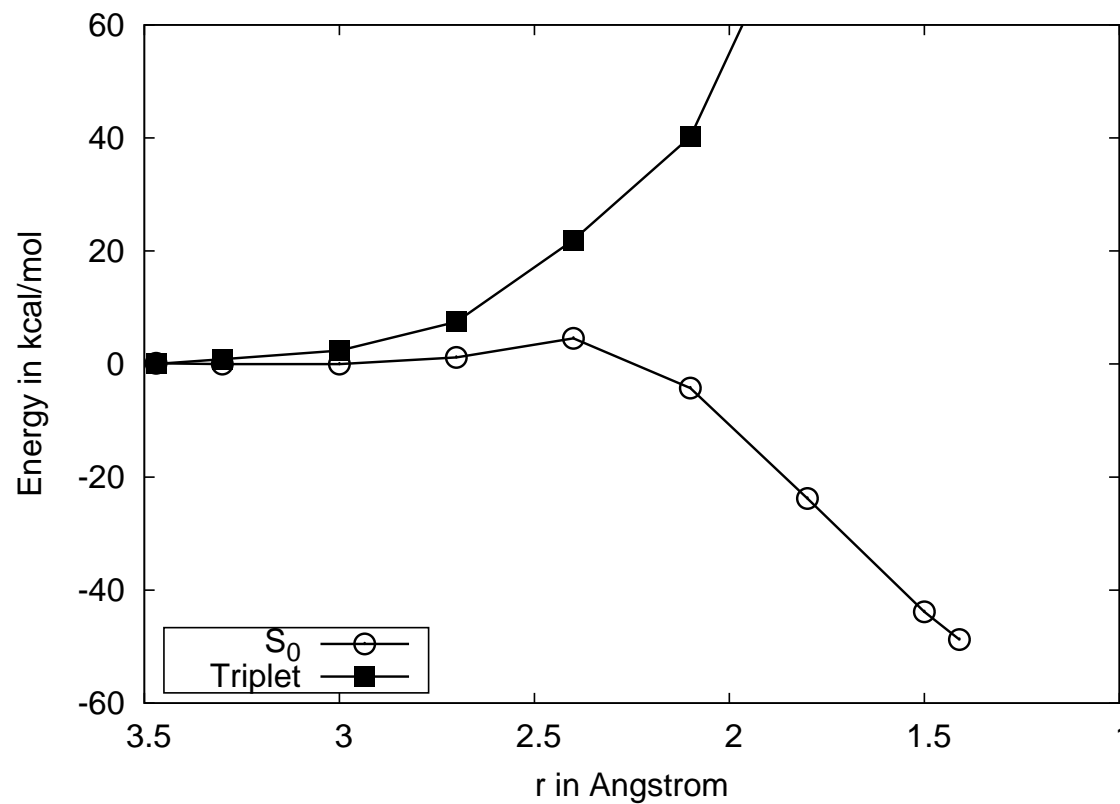
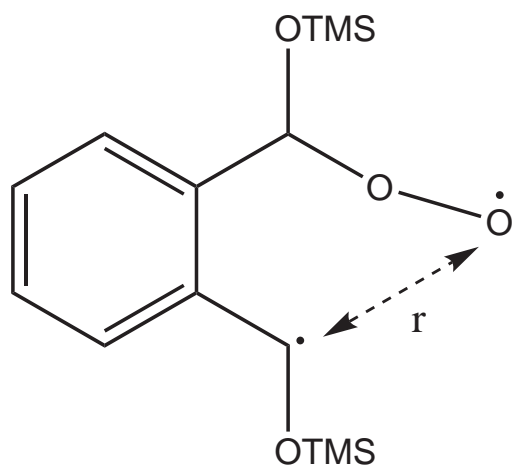

CAS(8,8) + CISD along the closing of C-O.

Complete pathway

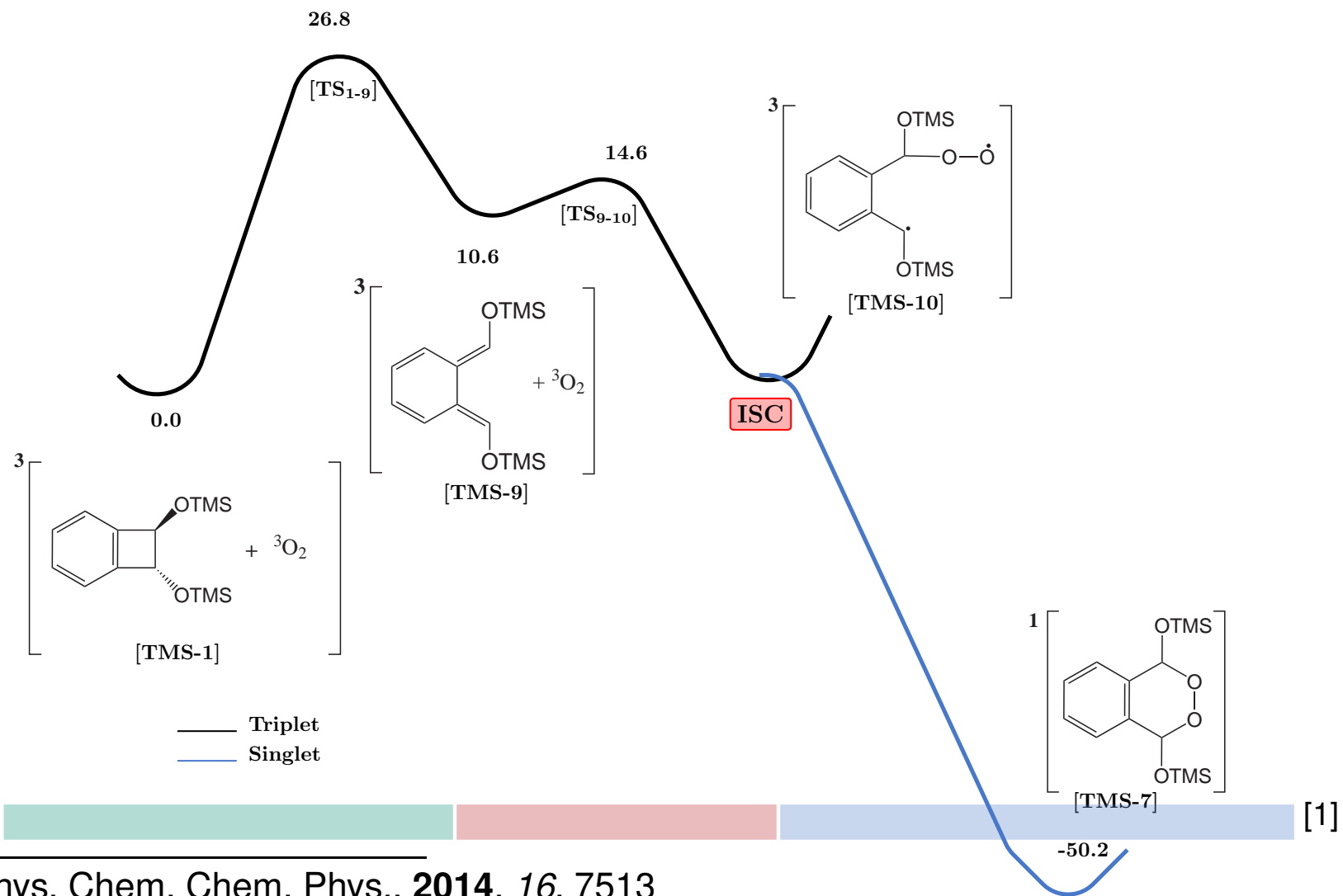

Photoactivation

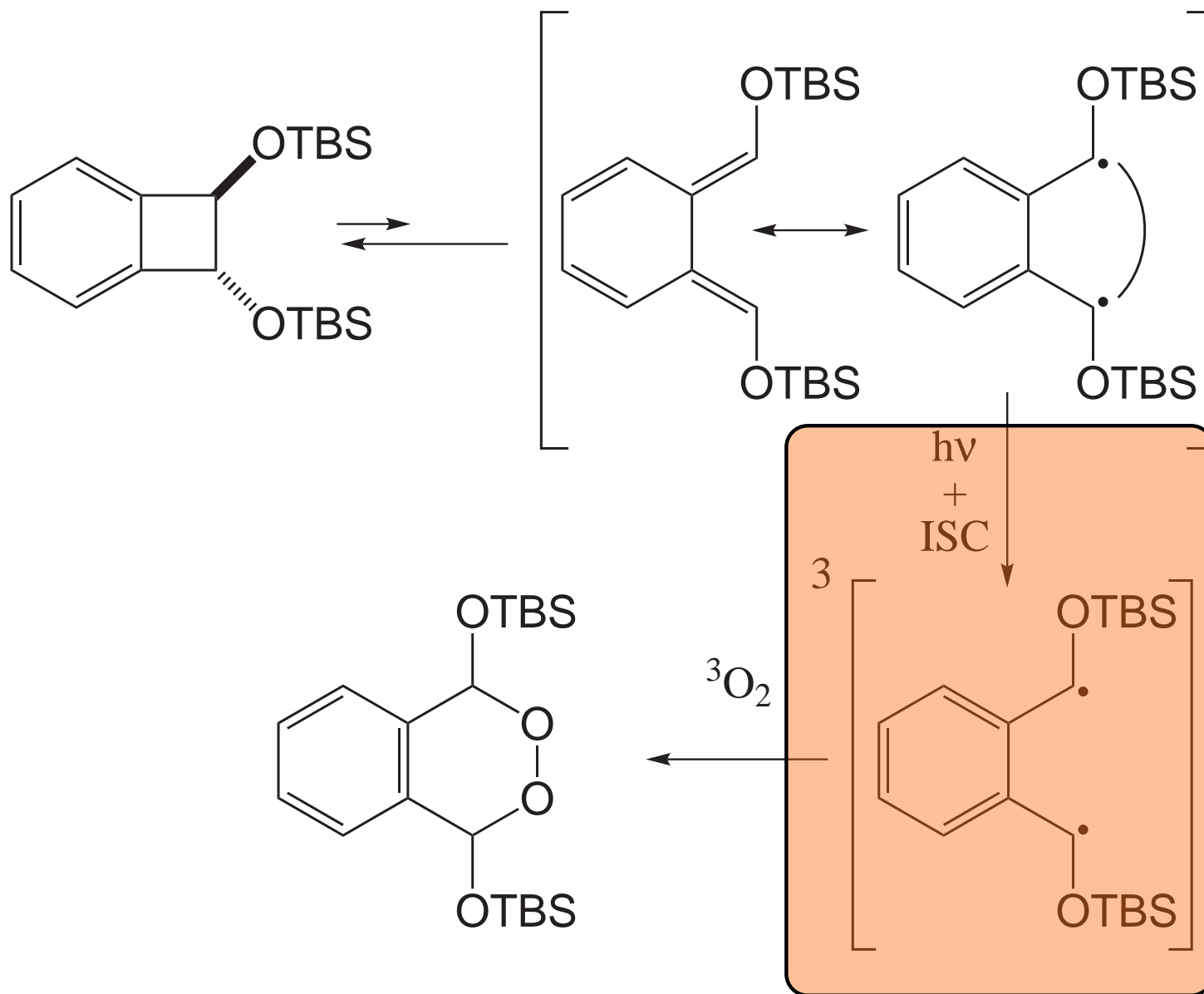

Photoactivation

Theory

Experiment

Emission with excitation at 400nm

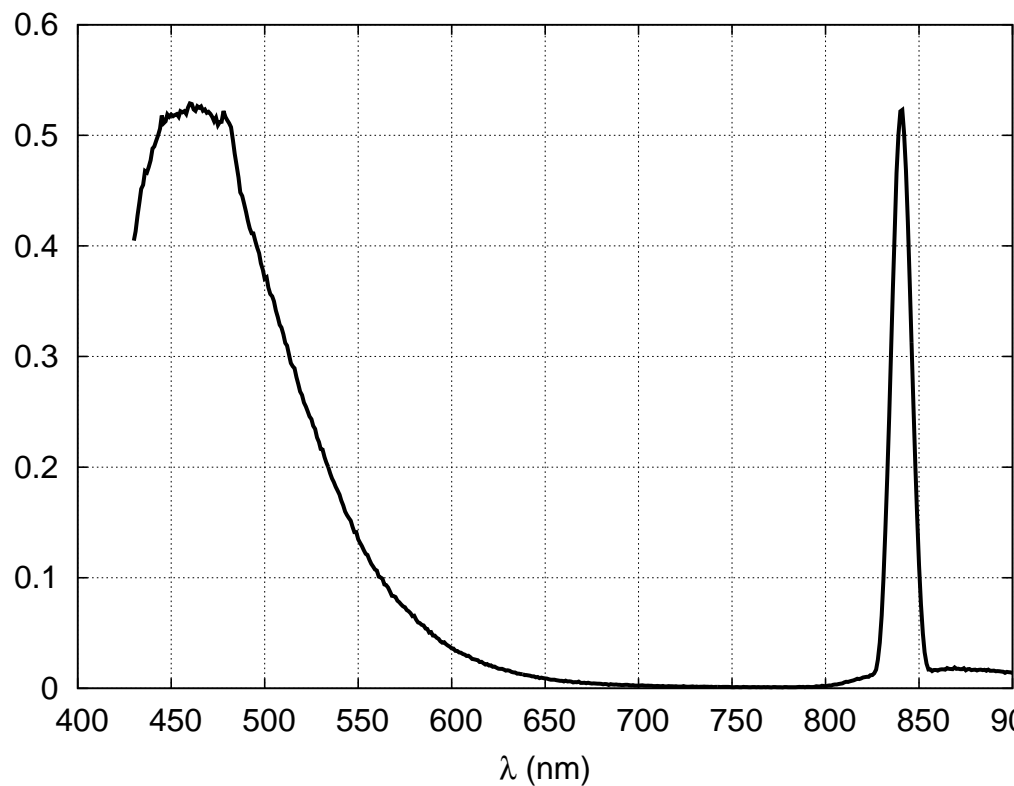
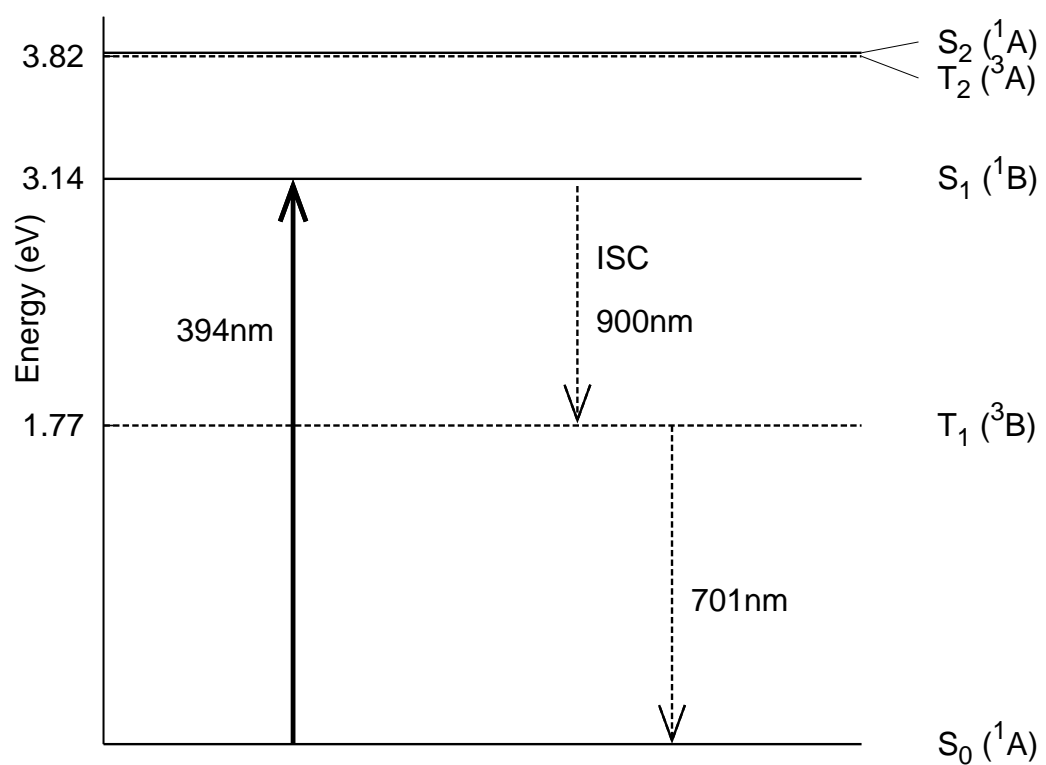

Photoactivation

Theory

Experiment

Emission with excitation at 312nm

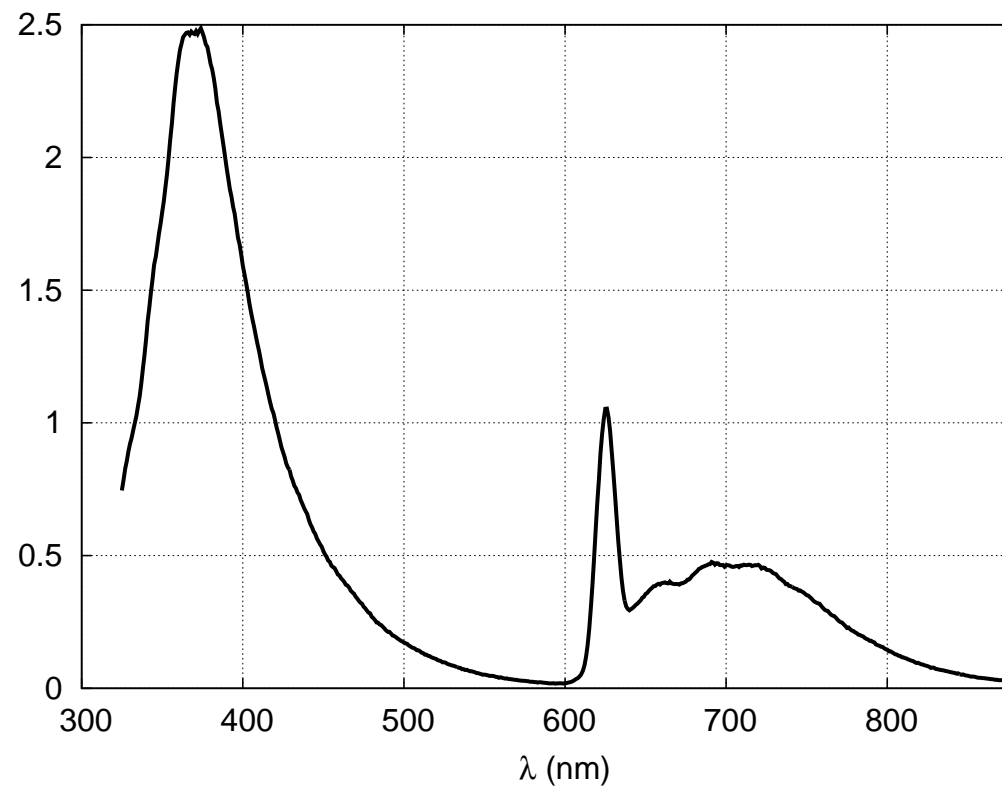
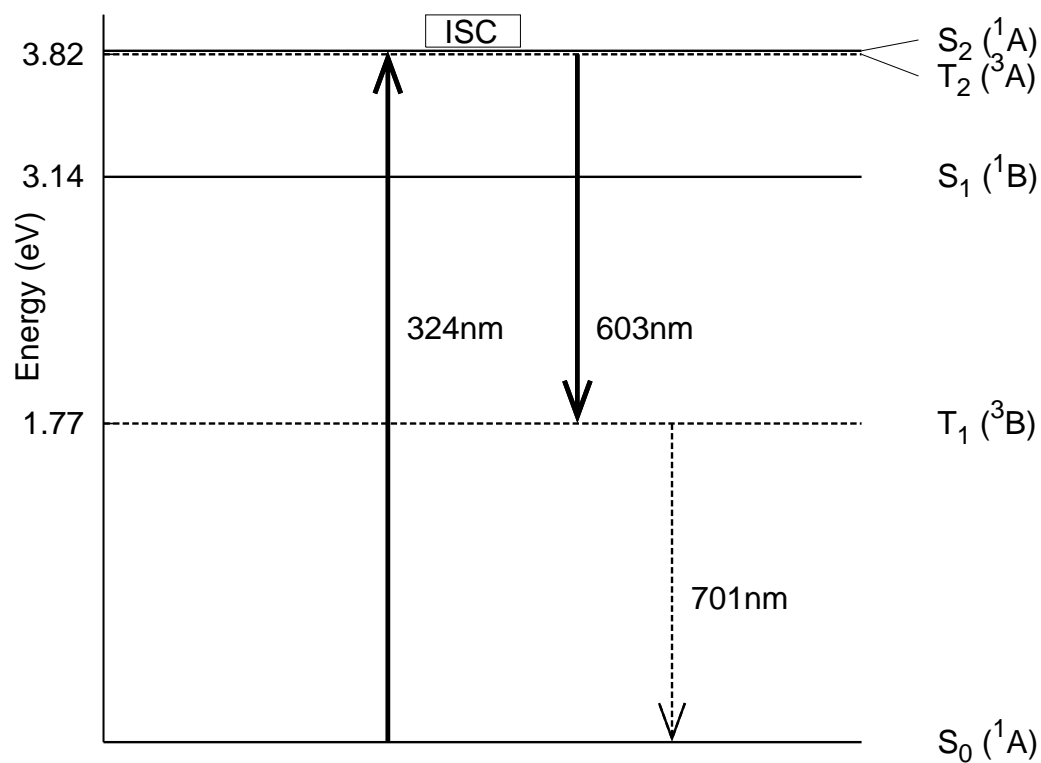

Photoactivation

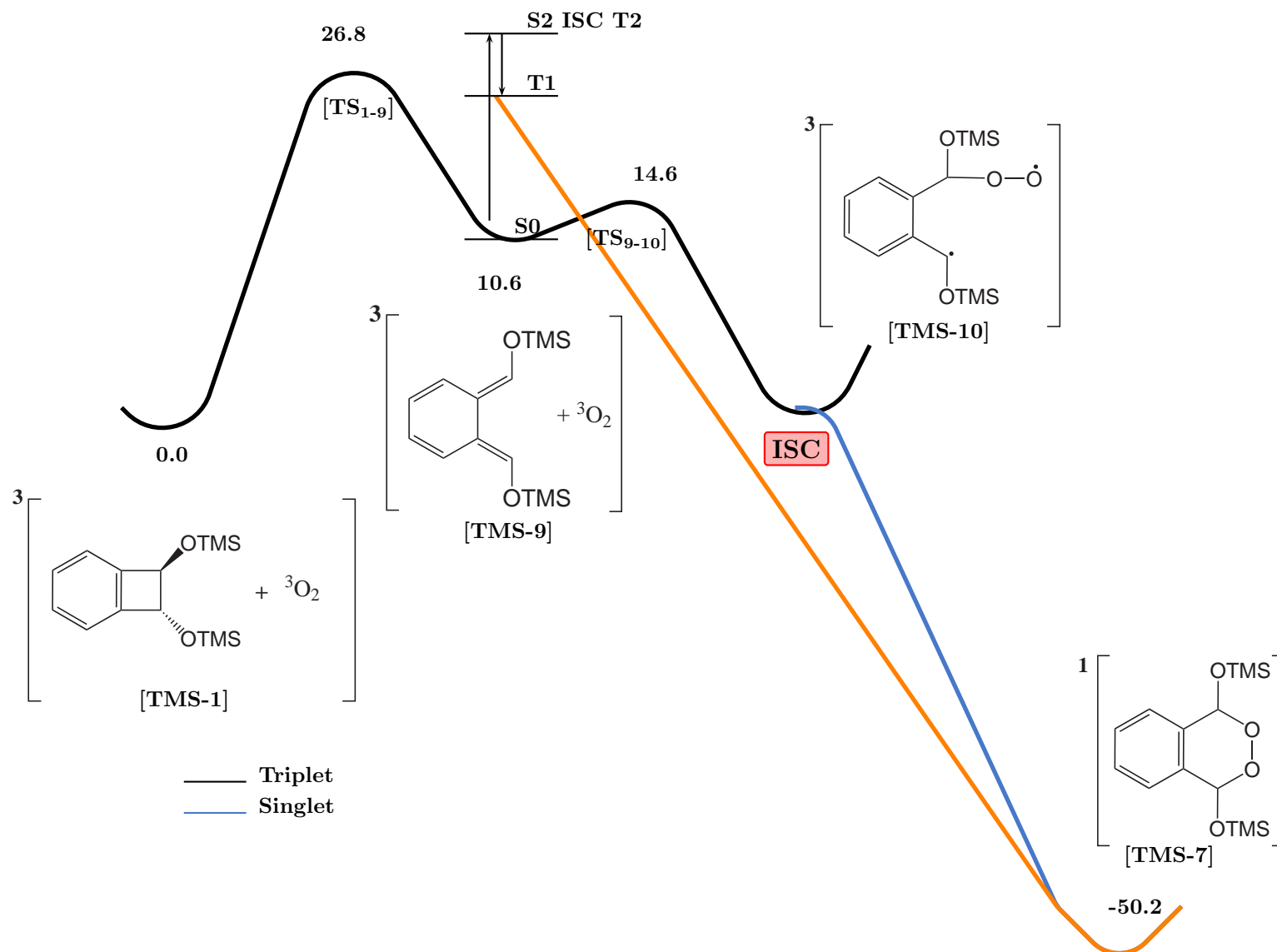

Pseudopotentials for hybridized carbon atoms

General aim

- A new model :
 - Treat explicitly electrons of interest only (π)
 - Replace part of a molecule by a simpler object
- Constraint :
 - Use any quantum chemistry package
 - Use any quantum chemistry method

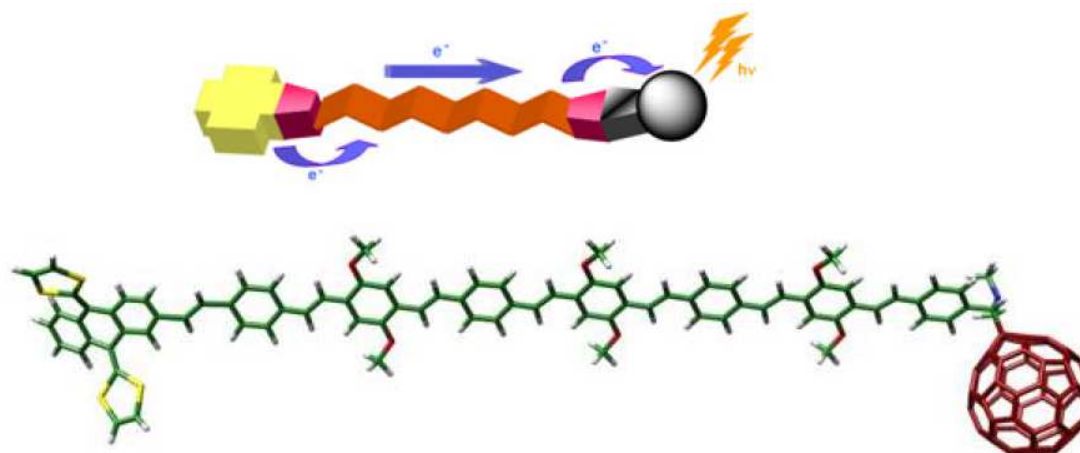

J. Am. Chem. Soc. 2009, 131, 12218-12229

Atomic pseudopotentials

A non local atomic pseudopotential reads :

$$\hat{P} = a|\varphi\rangle\langle\varphi| \quad (1)$$

$$\text{with } \varphi = R(r)Y_m^l(\theta, \phi) \quad (2)$$

\hat{P} is a shift operator on orbital φ : it modifies ϵ_φ .

$R(r)$ is usually a gaussian function $\exp(-\alpha r^2)$.

Y_m^l defines the angular momentum influenced by the potential.

Atomic pseudopotentials : Perturbation analysis

$$\hat{F}^{(0)} \Phi_n^{(0)} = \epsilon_n^{(0)} \Phi_n^{(0)} \quad (3)$$

$$\hat{F} = \hat{F}^{(0)} + a|\varphi\rangle\langle\varphi| \quad (4)$$

$$\epsilon_n = \underbrace{\langle\Phi_n^{(0)}|\hat{F}^{(0)}|\Phi_n^{(0)}\rangle}_{\epsilon_n^{(0)}} + \underbrace{\langle\Phi_n^{(0)}|a|\varphi\rangle\langle\varphi|\Phi_n^{(0)}\rangle}_{\Delta\epsilon_n} \quad (5)$$

$$\Delta\epsilon_n = a\langle\varphi|\Phi_n^{(0)}\rangle^2 \quad (6)$$

Two parameters to modify the original orbitals :

1. a (eigenvalue)
2. shape of φ (angular momentum and spatial extent)

From atomic to molecular shaped pseudopotentials

We aim at treating the π electrons *only*. For carbon atoms :

- 1 electron in 1 p_z atomic orbital ;
- effective atomic charge $Z=1$.

Ring a bell ?

—————→ Complexity



Hückel

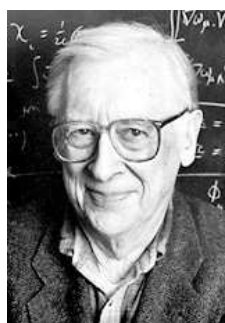

PPP

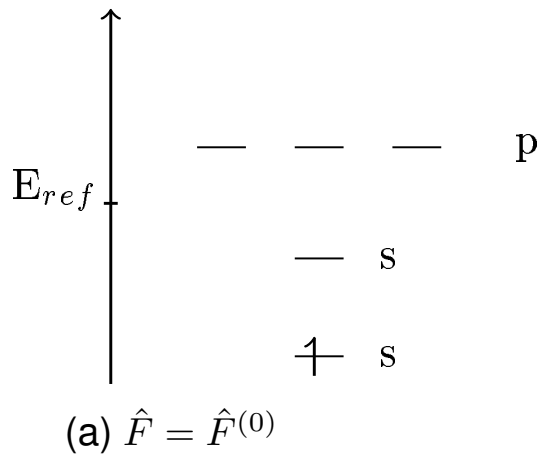
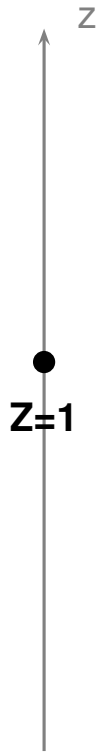

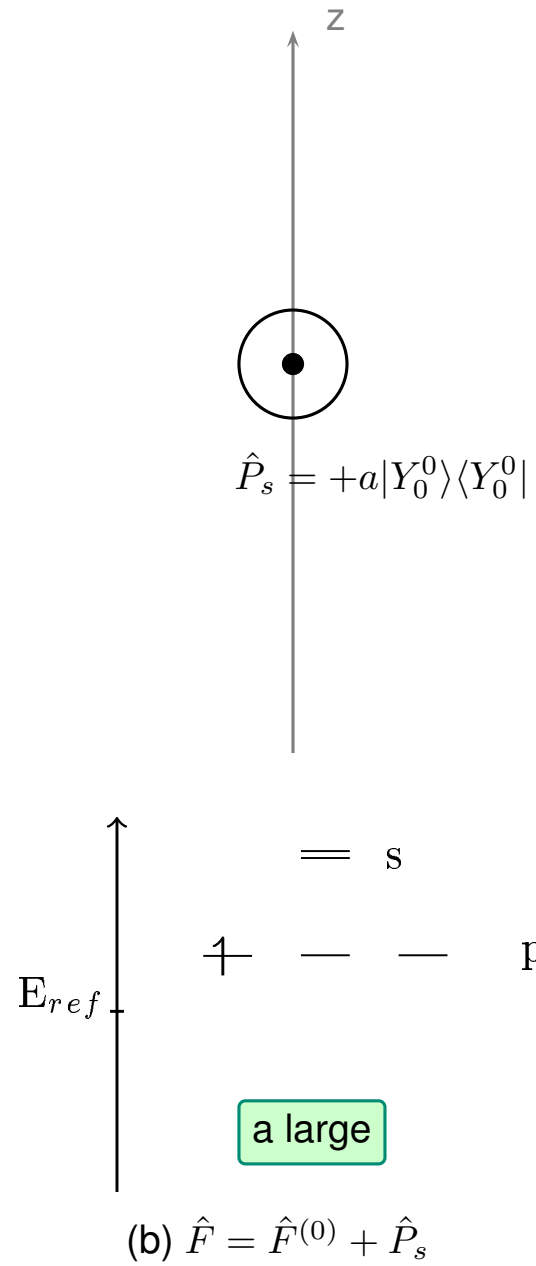
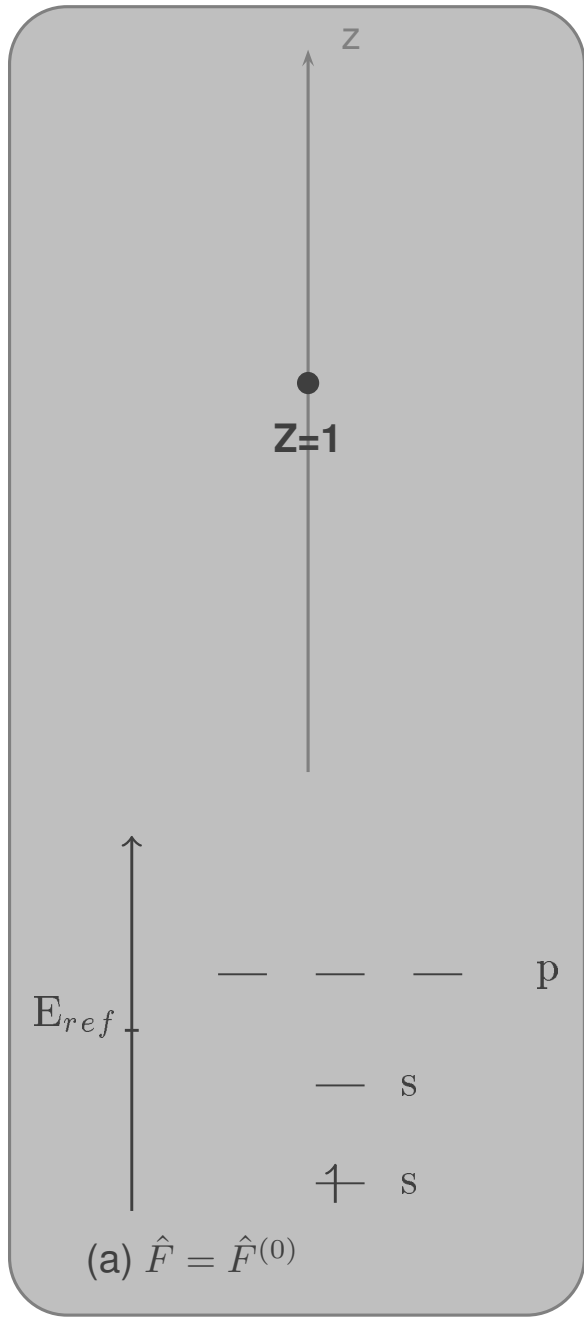

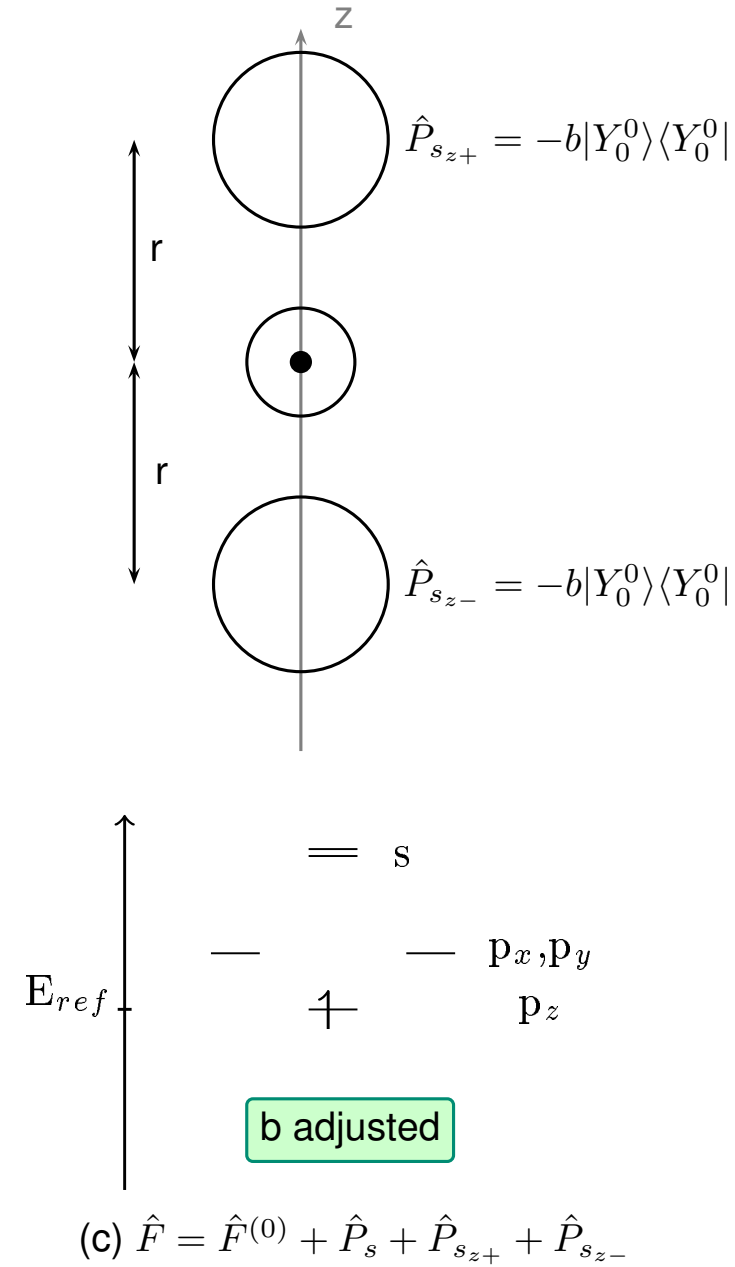
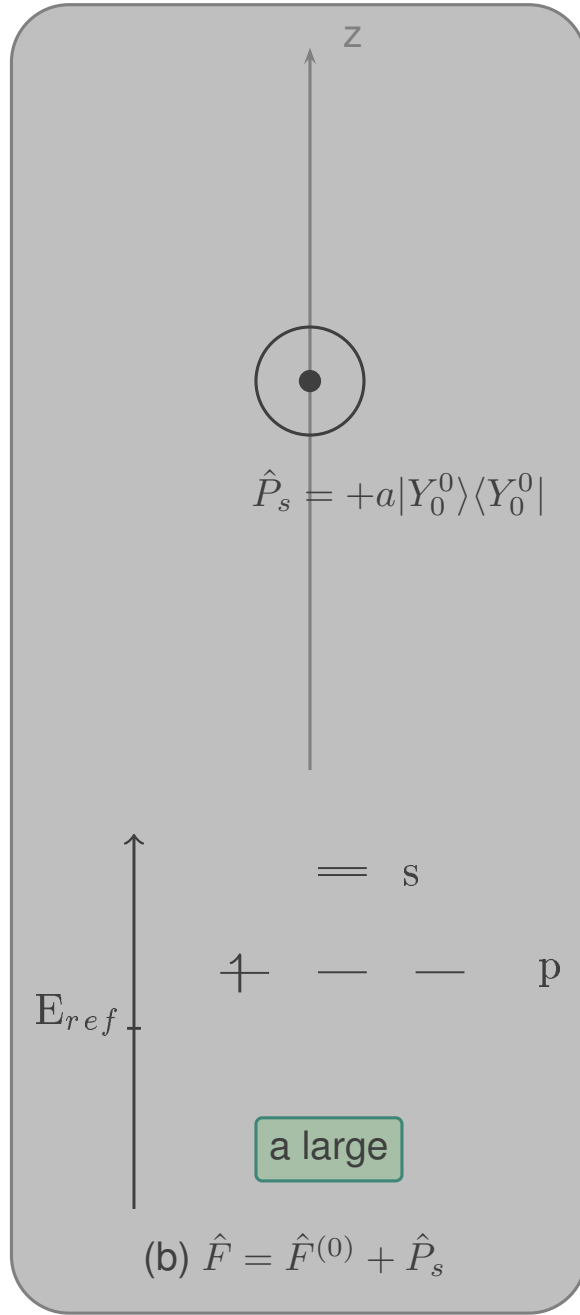
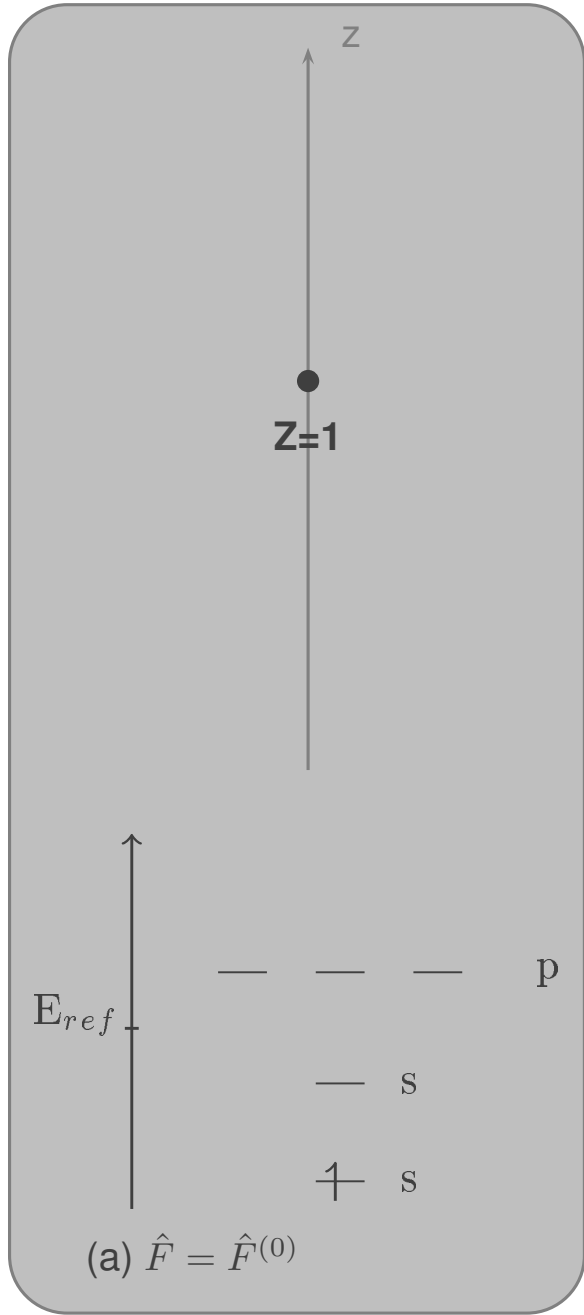

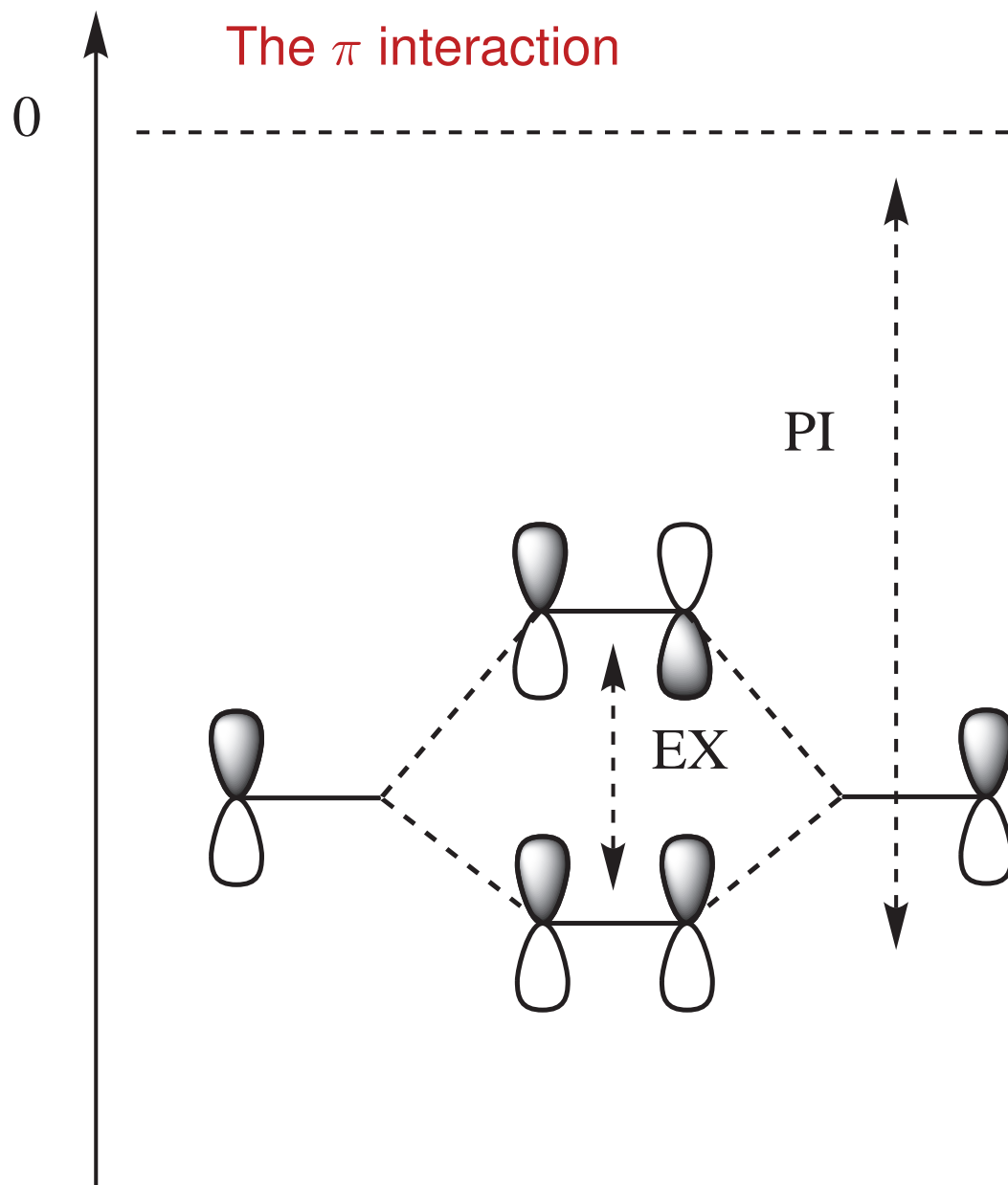

- Shape of orbitals OK
- Excitation energy WRONG
- Ionization potential WRONG

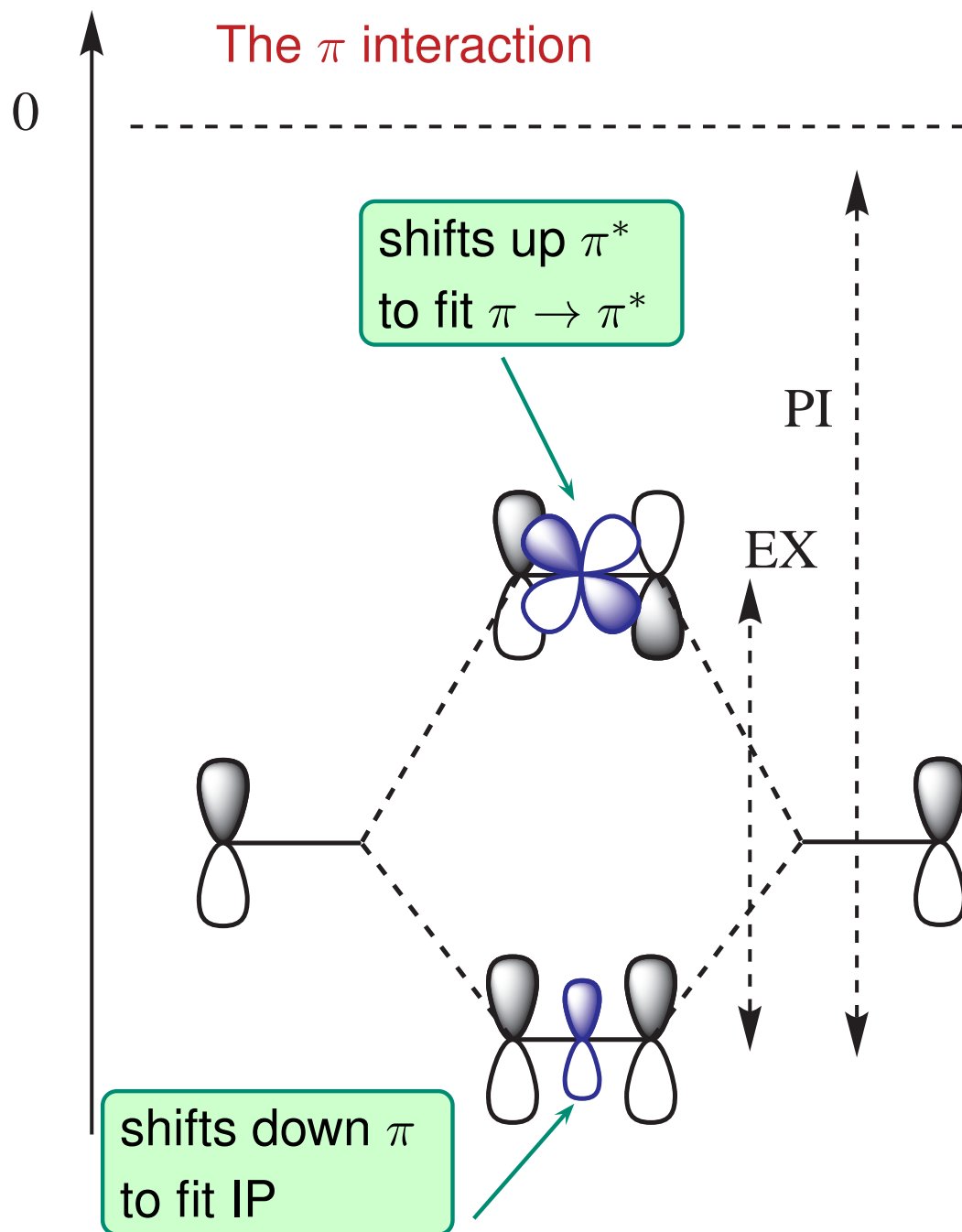

- Shape of orbitals OK
- Excitation energy OK
- Ionization potential OK

Combination of CC bonds : all trans even polyenes

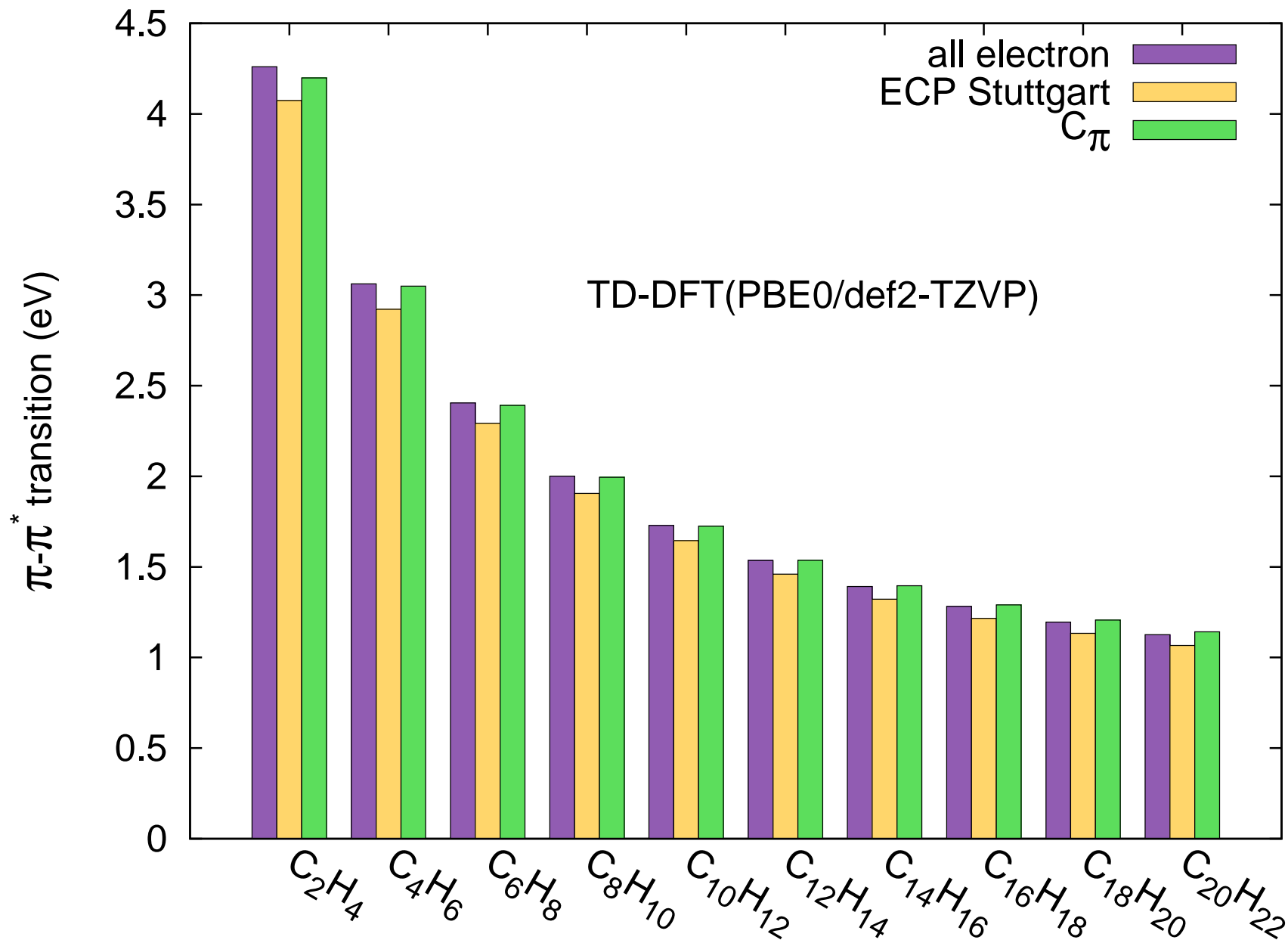

Fused rings

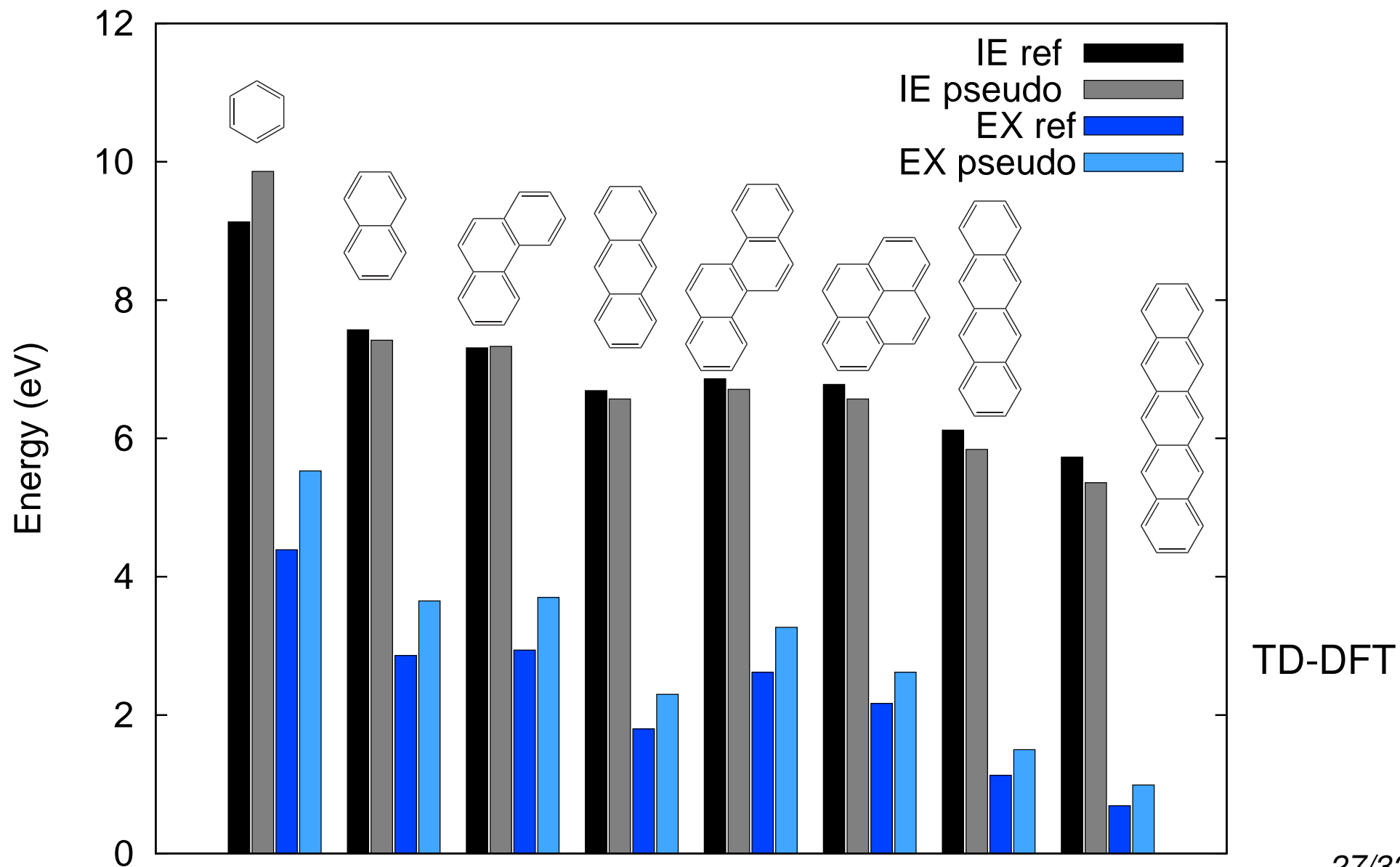

σ bond

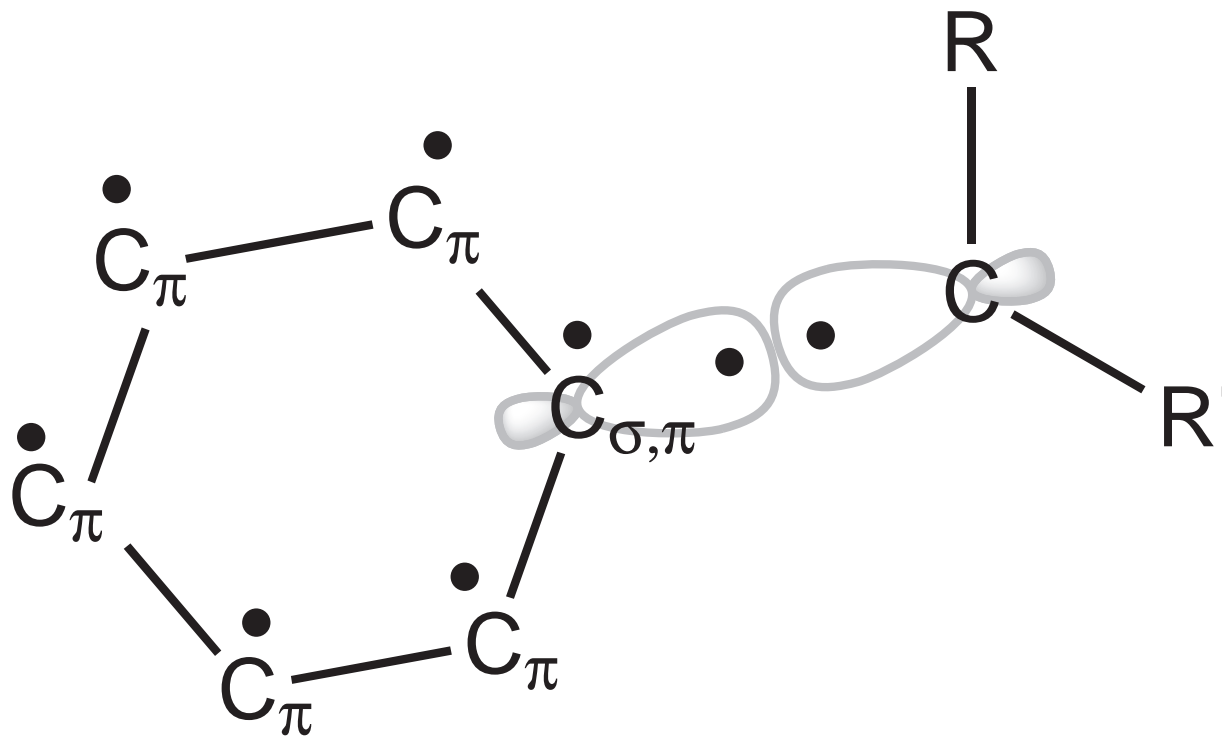

Extraction of $C_{\sigma,\pi}$:

- $Z=2$
- 1 electron in p_z and 1 electron in sp

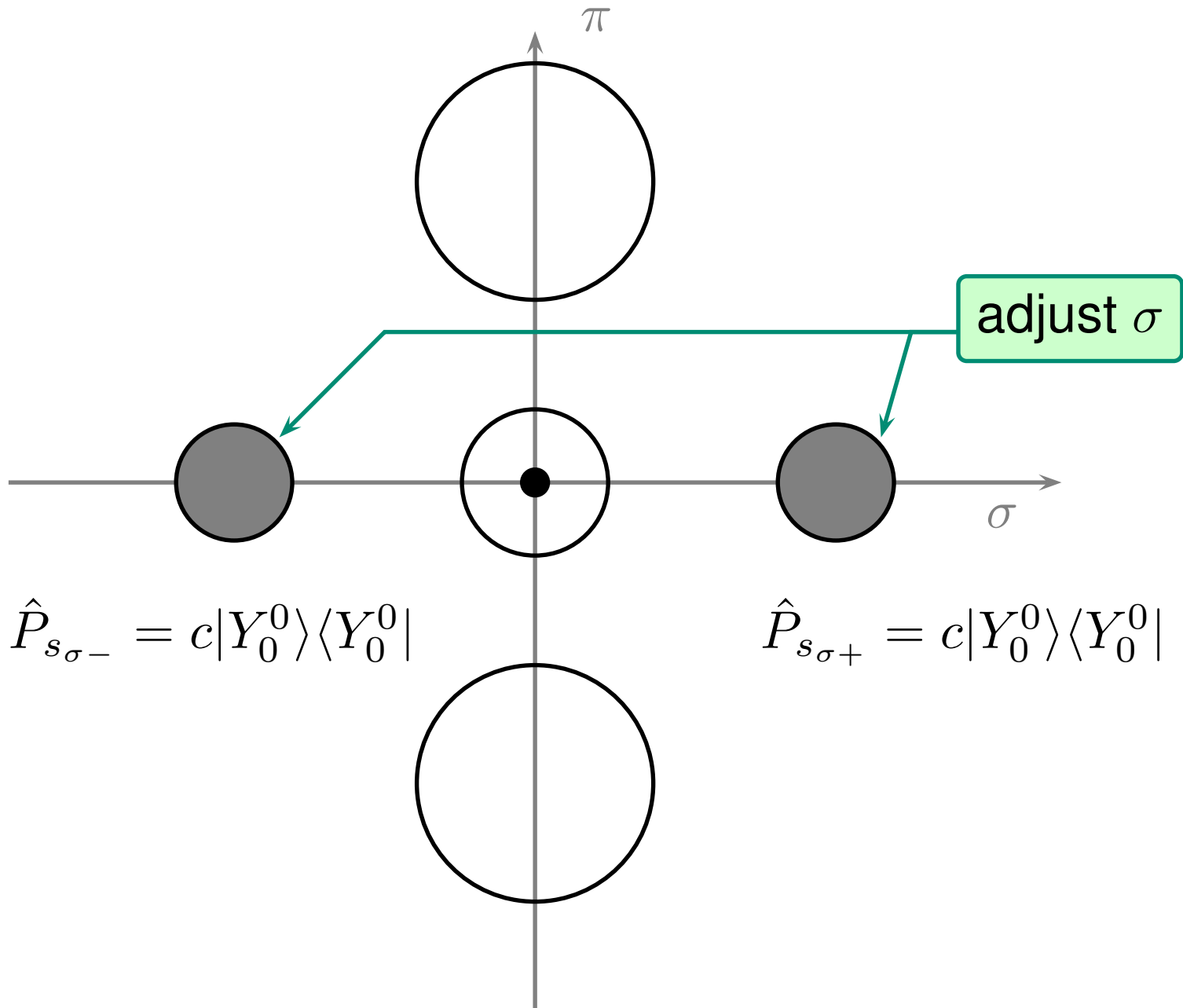

Bonding to an active part

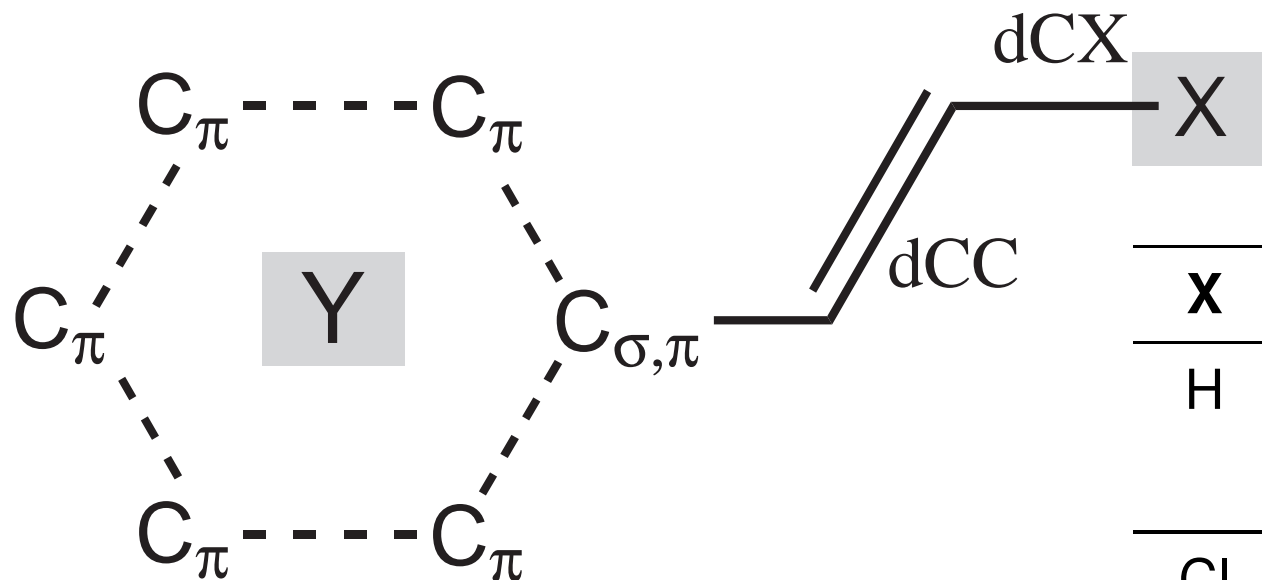

X	Y	dCC	dCX
H	C_6H_5	133.1	107.2
	$(C)_5C_{\sigma,\pi}$	132.0	107.3
Cl	C_6H_5	132.2	180.7
	$(C)_5C_{\sigma,\pi}$	131.6	181.1
Br	C_6H_5	132.4	193.2
	$(C)_5C_{\sigma,\pi}$	131.7	193.5
Me	C_6H_5	133.2	150.9
	$(C)_5C_{\sigma,\pi}$	132.4	151.1

Conclusion

- We could create pseudopotentials for hybridized carbon atoms
- Use any QC package and any QC method
- Spectroscopy and geometry optimization
- Extension to other atoms with π electrons
- Other kind of hybridization tricky (σ π orthogonality used)

Merci

- UV analysis
 - Jalila Simaan
 - Bruno Faure
- Co-workers
 - Béatrice Tuccio
 - Laurent Commeiras
 - Jean-Luc Parrain
- iSm2
 - The logo for Aix*Marseille université, featuring a blue curved line on the left, the text 'Aix*Marseille' in black, and 'université' in blue below it.
- You for your attention