



HAL
open science

Uncertainties in CMM Measurements, Control of ISO Specifications

J. Sprael, J. Linares, J. Bachmann, P. Bourdet

► **To cite this version:**

J. Sprael, J. Linares, J. Bachmann, P. Bourdet. Uncertainties in CMM Measurements, Control of ISO Specifications. CIRP Annals - Manufacturing Technology, 2003, 52 (1), pp.423-426. 10.1016/S0007-8506(07)60616-7. hal-01408960

HAL Id: hal-01408960

<https://amu.hal.science/hal-01408960>

Submitted on 5 Dec 2016

HAL is a multi-disciplinary open access archive for the deposit and dissemination of scientific research documents, whether they are published or not. The documents may come from teaching and research institutions in France or abroad, or from public or private research centers.

L'archive ouverte pluridisciplinaire **HAL**, est destinée au dépôt et à la diffusion de documents scientifiques de niveau recherche, publiés ou non, émanant des établissements d'enseignement et de recherche français ou étrangers, des laboratoires publics ou privés.

Uncertainties In CMM Measurements, Control of ISO Specifications

J.M. Sprauel¹, J.M. Linares¹, J. Bachmann¹, P. Bourdet² (1)

¹ EA(MS)², I.U.T., Avenue Gaston Berger, 13625 Aix en Provence cedex 1, France

² E.N.S Cachan, 61 Avenue Président Wilson, 94230 Cachan, France

Abstract

In the scope of quality control, accurate evaluation of measurement uncertainties is a real challenge to improve the use of Coordinate Measuring Machines (CMM). In our work, a new method, based on a statistical approach of the problem, was therefore developed, to deduce instantaneous measurement uncertainties directly from the set of acquired coordinates. The covariance matrix of the intrinsic parameters which characterize each analyzed surface is also evaluated, thus allowing an accurate propagation of the measurement uncertainties to the ISO specifications to be controlled. The experiments carried out in our study illustrate this new statistical approach and demonstrate its relevance.

Keywords:

Coordinate measuring machine, Uncertainty, Statistical

1 INTRODUCTION

Coordinate measuring machines are now widely used to qualify industrial workpieces. Nevertheless, the actual CMM software is usually restricted to the determination of mean values. This is the case for both the characterization of individual surfaces and for the determination of geometric deviations. However, in accordance with quality standards, the uncertainty of each measurement should also be specified [1]. This becomes increasingly important in industrial routine. For simple processes, like calliper or micrometer measurements, the evaluation of uncertainties by a conventional method as recommended by the GUM [2] is straightforward. However, this procedure becomes extremely tedious or even impossible for coordinate measurements.

Actually, the uncertainties of such measurements are therefore either deduced from repeated expensive experiments or estimated through numerical simulations [3,4]. The latter methods require however to decompose the measurement process into a set of elementary functions and to identify all the associated independent random variables. In addition, the intrinsic parameters of the analyzed surfaces are then assumed to be independent one of the other, thus leading to a wrong determination of the error bars of the ISO specifications to be qualified. Moreover, these methods do not account for uncontrolled events and resulting perturbations which may occur during the acquisition.

Another way to evaluate the uncertainties of CMM measurements is to use a statistical approach of the problem. In fact, the set of digitized coordinates forms a statistical sampling of the true analyzed surface. It contains therefore some mixed information about the distribution of the material around the ideal geometric element and about the quality of the measurement. This property has already been pointed out by different authors [5,6,7], but has not yet been used to evaluate the uncertainties of CMM measurements. A new method was therefore developed in our laboratory, to deduce instantaneous measurement uncertainties directly from the set of acquired coordinates [8]. The covariance matrix of the intrinsic parameters which characterize each analyzed surface is also evaluated, thus allowing an

accurate propagation of the measurement uncertainties to the ISO specifications to be controlled. The experiments carried out in our study will illustrate this new statistical approach and will demonstrate the relevance of the methods developed in our work.

2 PRINCIPLE OF THE METHOD

2.1 Fitting of elementary surfaces

The first step required in the treatment of coordinate measurements is the description of each digitized surface by an ideal feature. Each geometric entity is characterized by a set of p intrinsic parameters a_i : coordinates of the centre of the measured surface, cosines of the normal to a plane or of the direction vector of an axis, radius, angle of a cone, etc. The fitting of the acquired data comes thus to the optimization of these parameters a_i in order to obtain the best layout of the measured coordinates around the ideal feature. It is usually based on the minimization of the distance d_k between N acquired points M_k and the associated geometric element. Different procedures are used for that purpose like the classical least squares method or the Tchebychev criterion. In our study, these methods have been extended to a statistical approach of the problem [8].

The distribution of the measured coordinates around the ideal feature is characterized therefore by its probability density function $f(d_k)$. According to the maximum likelihood criterion, the best statistical estimator's \hat{a}_i of the parameters a_i have to maximize the conditional probability ϕ of all the realized independent measurements:

$$\phi = \prod_{k=1}^N f(d_k) \text{ to be maximized } \Rightarrow \frac{\partial \phi}{\partial \hat{a}_i} = 0 \quad (1)$$

We suppose now that all the systematic errors have been corrected in the acquired data. Therefore, the deviations included in the measured coordinates just result from the convolution between statistical perturbations of the coordinate measuring machine and the distribution of the matter around the ideal geometric element. Since the instrument depends on a great number

of uncontrolled parameters, the first deviation is usually associated with a normal law. The second component is more difficult to define. However, for high quality surfaces, measurements carried out on different industrial pieces, have shown that the scattering of the matter around the ideal geometric element can then be reasonably approximated by a Gaussian distribution. This is a first step of our statistical approach, but other distributions will be tested in the near future for rough surfaces. Under these assumptions, the likelihood criterion simplifies to the classical least squares method and the optimization conditions become:

$$\phi = \left(\frac{1}{\sigma\sqrt{2\pi}} \right)^N \text{Exp} \left[-\frac{1}{2} \sum_{k=1}^N \left(\frac{d_k}{\sigma} \right)^2 \right] \Rightarrow \sum_{k=1}^N d_k \frac{\partial d_k}{\partial \hat{a}_i} = 0 \quad (2)$$

If the p parameters a_i of the geometric element associated to the digitized surface were perfectly defined, the standard deviation σ could also be estimated in the same way:

$$\frac{\partial \phi}{\partial \hat{\sigma}} = 0 \Rightarrow \hat{\sigma} = \sqrt{\frac{1}{N} \sum_{k=1}^N d_k^2} \quad (3)$$

However, such estimator would lead to a biased evaluation of σ , because a set of p parameters \hat{a}_i has already been derived from the acquired data. Therefore, the standard deviation of the measurement has to be computed with the following expression, also called residue of the least squares optimization:

$$\hat{\sigma} = \sqrt{\frac{1}{N-p} \sum_{k=1}^N d_k^2} \quad (4)$$

This deviation $\hat{\sigma}$ can be propagated to deduce the covariance matrix of the estimated parameters \hat{a}_i , using equation (2) and the classical differential expressions of the uncertainties [2]. From the diagonal components of the covariance matrix, the error bars of \hat{a}_i are then easily calculated, since the statistical distribution of these random variables corresponds to a Fisher-Student law.

2.2 Uncertainties of ISO 1101 specifications

The covariance matrix determined on each elementary feature can now be used to propagate the standard deviations of the fitted surfaces to any derived geometric element. The uncertainties of the dimensions and geometric deviations to be verified can thus be evaluated. At present, however, our method restricts to the control of ISO 1101 specifications. According to this standard, each dimension and geometric error is then qualified by a distance δ . This distance δ is derived from different geometric constructions and is linked to n of the parameters a_i determined by the fitting of the elementary features. Using a differential formulation of its standard deviation σ_δ it comes:

$$\sigma_\delta^2 = \sum_{i=1}^n \sum_{j=1}^n \frac{\partial \delta}{\partial a_i} \text{Cov}(a_i, a_j) \frac{\partial \delta}{\partial a_j} \quad (5)$$

Introducing the Jacobian matrix J of the distance δ and its transpose J' , this expression can also be rewritten as a matrix product:

$$\sigma_\delta^2 = J C J' \quad , \text{ where } J_i = \frac{\partial \delta}{\partial a_i} \text{ and } C_{ij} = \text{Cov}(a_i, a_j) \quad (6)$$

The evaluation of the standard deviation σ_δ comes thus to the determination of the Jacobian matrix J . For that purpose, a generic algorithm has been developed which allows computing its components whatever geometric construction has been used to derive the distance δ .

3 EXPERIMENTAL APPLICATION

In order to validate our new statistical approach, different experiments have been carried out in our laboratory using a coordinate measuring machine equipped with a touch trigger probe system mounted on an indexing head. All the measurements have been conducted in programmed automatic mode. The acquisition speed was kept constant and set to half the maximum sampling rate of the coordinate-measuring machine.

3.1 Uncertainties of single point measurements

The uncertainties obtained in single point measurements have been characterized first to define the random perturbations of the coordinate measuring machine. A MCG checking gauge was used for that purpose with a pivoting arm of 151 mm (Figure 1).

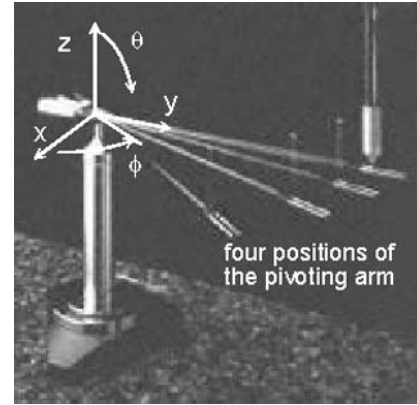

Figure 1: Machine checking gauge system.

Such a system, designed to test the volumetric performance of a coordinate measuring machine, permits analyzing the reference pivoting arm in a great range of (ϕ, θ) inclinations. Single point measurements were thus carried out for 24 evenly distributed directions. The acquisitions were repeated 144 times. This allowed, for each inclination of the system, to compute the covariance matrix of the digitized coordinates, using classical statistical formulae. Since the points were always acquired in the direction normal to the pivoting arm, all the components of this matrix were found of second order, except for the direction of measurement. The standard deviation of the pivoting radius is thus sufficient to characterize the acquisitions. The results are presented in Table 1.

| | θ (°) | | |
|------------|--------------|------|------|
| ϕ (°) | 45 | 90 | 135 |
| 180 | 0,75 | 0,68 | 0,78 |
| 135 | 0,80 | 0,72 | 0,93 |
| 90 | 0,69 | 0,68 | 1,00 |
| 45 | 0,80 | 0,76 | 0,75 |
| 0 | 0,78 | 0,65 | 0,85 |
| -45 | 0,88 | 0,66 | 0,67 |
| -90 | 0,95 | 0,61 | 0,66 |
| -135 | 0,94 | 0,83 | 0,92 |

Table 1: Standard deviations of measurement in μm .

With a confidence level of 99 %, Fisher tests applied to this data demonstrate that the standard deviation can be considered as constant for all the scanned directions. The whole acquired points could therefore be used to characterize the stochastic noise of our coordinate measuring machine. Figure 2 shows the histogram of the deviations measured in this first experiment.

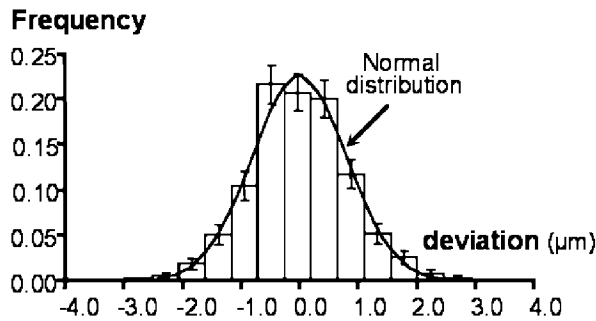

Figure 2: Histogram of the stochastic noise of the CMM. This graph demonstrates that the random perturbations of our machine can be accurately described by a Normal distribution.

3.2 Uncertainties of elementary features

In the second step of our experiments the artifact of Figure 3 was tested to check our new statistical approach.

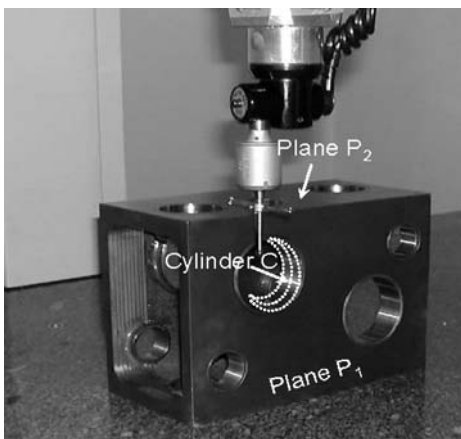

Figure 3: Artifact used in our experiment.

For this sample, all the planes were acquired in 20 evenly distributed points. The cylinders were characterized by three circles defined by 16 points. The measurements were repeated 151 times to allow the standard deviations of the results to be defined in a classical way. Figure 4 shows the results obtained for the testing of Plane P₁ which is a surface of high quality.

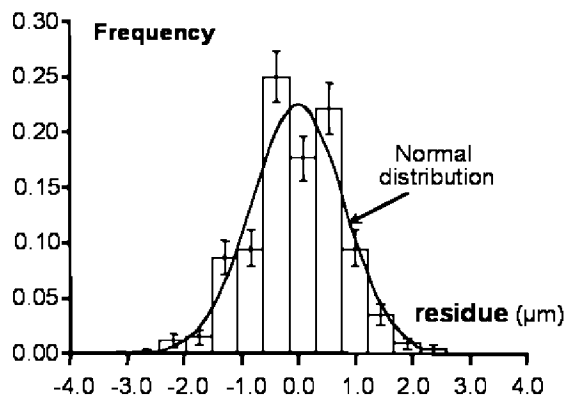

Figure 4: Histogram of the residues of plane P₁.

For this feature, the standard deviations were found to be the same for all the acquired points. The whole 151 x 20 digitized coordinates of the experiment were therefore used to define the histogram of the least squares optimization residues. This result has been compared to the data obtained for single point acquisitions (Figure 5).

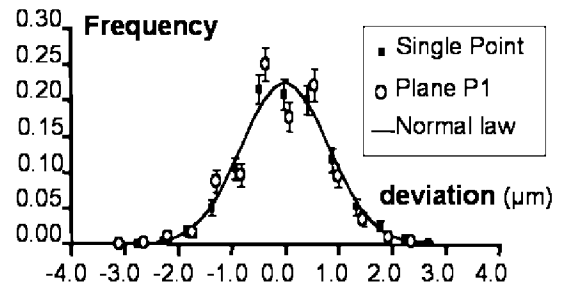

Figure 5: Comparison between the deviations obtained for single point acquisitions and for testing of Plane P₁.

Both distributions are practically the same. This means that for surfaces with low form defect, like plane P₁, the least squares fitting residues are directly linked to the stochastic noise of the coordinate measuring machine. It demonstrates clearly that the random deviations of the CMM are included in the set of acquired coordinates and can therefore be characterized by our statistical approach.

The next experimental part is now dedicated to the control of the location deviation between cylinder C and plane P₂. Three circles C₁, C₂, C₃ have therefore been measured on the cylindrical surface to define the axis of this entity. Figure 6 shows the histogram of the least squares residues obtained for the first acquired circle C₁.

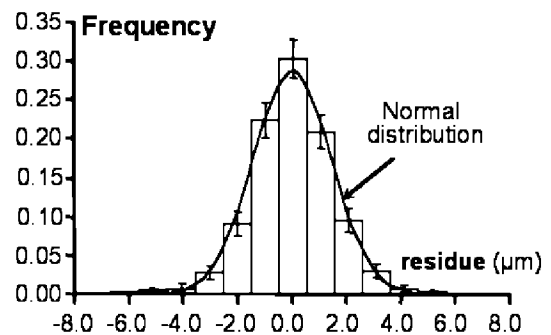

Figure 6: Distribution of least squares residues of C₁.

Again, the distribution of the least squares residues is Gaussian. However, in that case, its standard deviation is about two times greater than the value found for single point measurements. This is due to the form defect of the cylindrical surface, which was evaluated to 11 μm. Such result demonstrates now that the acquired coordinates also include statistical information about the distribution of the matter around the perfect ideal feature which is fitted to the measured points. The same type of results is obtained too for the two other circles.

It has however to be pointed out that the layout of the matter around the fitted feature cannot always be described by a normal distribution because it closely depends on the manufacturing process. In the general case the deviations included in the measured coordinates will then result from the convolution between the Gaussian contribution of the coordinate measuring machine and the process related geometrical surface defects of the analyzed sample.

The characterization of the location deviation between cylinder C and plane P₂ required finally to acquire this last surface.

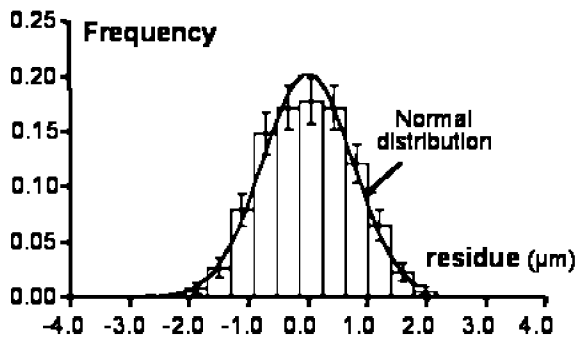

Figure 7: Histogram of the residues of plane P_2 .

Figure 7 shows the histogram obtained for this entity. As for plane P_1 , due to the low form defect of the surface, the residues of the least squares fitting correspond to the stochastic noise of the coordinate measuring machine.

3.2 Uncertainties of geometric deviations

From each set of acquisitions carried out on circles C_1 , C_2 , C_3 and plane P_2 , the geometric errors of cylinder C could finally be defined. According to ISO 1101 standard, the location deviation of cylinder C has been deduced from the distances between the centers of circles C_1 , C_2 , C_3 and plane P_2 . Since the experiment was repeated 151 times, the standard deviations of these distances could also be computed in a classical way.

On the other hand, as already pointed out, our new statistical approach allows also to estimate the covariance matrix of the intrinsic parameters evaluated for each elementary surface. This information has been propagated to the calculated distances, thus defining the standard deviations in a second manner. For each set of data, these values are then just derived from the 20 points acquired to characterize plane P_2 and the 3×16 coordinates which define cylinder C . The results are presented in table 2.

| | standard deviation (μm) | |
|--------------------|--------------------------------------|----------------------|
| | classical method | deduced from residue |
| Distance C_1/P_2 | 1,30 | 1,51 |
| Distance C_2/P_2 | 1,39 | 1,35 |
| Distance C_3/P_2 | 1,52 | 1,37 |

Table 2: Standard deviations of the measured distances.

The deviations deduced from the residue of the least squares optimization were of the same order for all the set of acquired surfaces. Only their mean values were therefore reported in this table. The results show clearly that the instantaneous standard deviations defined through our new statistical approach are very close to the values calculated by a classical method based on repeated measurements. This demonstrates clearly the relevance of our method.

4 CONCLUSION

In our work a new statistic approach has been developed to evaluate instantaneous uncertainties of coordinate measurements. These uncertainties are derived from the residue between the perfect ideal features fitted to the acquired points and the related digitized coordinates. The method shows that due to the form defects of the measured surface, the deviations of the results obtained with a given algorithm not only depend on the stochastic noise of the CMM but are also linked to the points distribution selected on the measured surface. The experimental results obtained in our study demonstrate clearly that the uncertainties derived from a single measurement using our statistical method are very close to the values defined by repeated tests. The instantaneous uncertainty evaluated through our approach will thus give a relevant indicator allowing to check a given CMM control process in order to optimize its procedures and experimental conditions.

At present, the method is limited to the verification of ISO 1101 tolerances and geometric deviations. The statistical approach will now be extended to the control of envelop requirements.

5 REFERENCES

- [1] Srinivasan, V., 2001, An Integrated view of Geometrical Product Specification and Verification, Proceedings of the 7th CIRP Seminar on Computer-Aided Tolerancing: 7-17.
- [2] 1993, Guide to the Expression of Uncertainty in Measurement, First Edition, International Organization for Standardization.
- [3] Balsamo, A. Di Ciommo, M., Mugno, M., Rebaglia, B.I., Cicci, E., Grella, R., 1999, Evaluation of CMM Uncertainty through Monte Carlo Simulations, Annals of the CIRP, 48/1:425-428
- [4] Schwenke, H., Siebert, B.R.L., Wüdele F., Kunzmann H., 2000, Assessment of Uncertainties in Dimensional Metrology by Monte Carlo Simulation, Annals of the CIRP, 49/1:395-397.]
- [5] Kurfess T., Banks, D.L., 1995, Statistical verification of conformance to geometric tolerance, Computer Aided Design, 27/5:353-361
- [6] Yau, H.T., 1997, Evaluation and uncertainty analysis of vectorial tolerances, Precision engineering, 20 :123-137.
- [7] Choi, W., Kurfess, T., 1998, Uncertainty of extreme fit evaluation for three-dimensional measurement data analysis, Computer Aided Design, 30/7:549-557.
- [8] Sprauel J.M., Linares, J.M., Bourdet P., 2001, Contribution of nonlinear optimization to the determination of measurement uncertainties, Proceedings of the 7th CIRP Seminar on Computer-Aided Tolerancing:285-291.