



HAL
open science

Inspection of Mechanical Tolerance by Using the Virtual Gauge on a Coordinate Measuring Machine

Salim Boukebbab, Jean-Marc Linares, Mohamed Salah Boulahlib, Jean-Michel Sprauel

► **To cite this version:**

Salim Boukebbab, Jean-Marc Linares, Mohamed Salah Boulahlib, Jean-Michel Sprauel. Inspection of Mechanical Tolerance by Using the Virtual Gauge on a Coordinate Measuring Machine. *Recent Patents on Computer Science*, 2009, 2 (2), pp.135 - 144. 10.2174/2213275910902020135 . hal-01426972

HAL Id: hal-01426972

<https://amu.hal.science/hal-01426972>

Submitted on 5 Jan 2017

HAL is a multi-disciplinary open access archive for the deposit and dissemination of scientific research documents, whether they are published or not. The documents may come from teaching and research institutions in France or abroad, or from public or private research centers.

L'archive ouverte pluridisciplinaire **HAL**, est destinée au dépôt et à la diffusion de documents scientifiques de niveau recherche, publiés ou non, émanant des établissements d'enseignement et de recherche français ou étrangers, des laboratoires publics ou privés.

Inspection of Mechanical Tolerance by Using the Virtual Gauge on a Coordinate Measuring Machine

Salim Boukebbab^{1,*}, Jean M. Linares², Med S. Boulahlib¹ and Jean M. Sprauel²

¹Laboratory of Mechanics, Faculty of Engineering Sciences, Mentouri-Constantine University, Road of Ain-el-Bey, 25000 Constantine, Algeria, ²Laboratory of EA(MS), Mediterranean University, Technology Institute University, Road of Gaston Berger, 13625 Aix-en-Provence Cedex 1, France

Abstract: The function to obtain associated surfaces on coordinate measuring machines (CMM's) is based on the minimization of the distance between measured points and the ideal surface. This function is non-linear for usual surfaces. In many works, to accelerate iterative calculations, the problem is linearized. The aim of this work is to reduce scraps using a transcription optimization of the fitting functionality of mechanical parts in maximum state of matter. An adaptive verification method is suggested. It takes account of the interface properties. A control by a virtual gauge and verification a process is developed to validate the tolerancing according to the previously suggested methodology.

Keywords: Virtual gauge, metrology, fitting, no linear method, optimization, least squares method, coordinate measuring machine.

1. INTRODUCTION

A machine, such as a coordinate measuring machine (CMM's), uses a material measure with a periodic division in order to determine spatial positions of a working or measuring head [1]. The principle of the CMM's software consists in individually associating an elementary mathematical model (plane, cylinder, etc) to each acquisition surface [2]. The function to be minimized is based on the distance y_i between the digitized point M_i and the theoretical surface. The result differs according to the chosen minimization criterion (least square, Tchebichev criterion, minimax...) [3-6]. This function is non-linear for usual surfaces (line in space, plane surface, cylinder, cone and sphere). To reduce the computing time of the optimization procedures, many works have approximated the displacement matrix to the first order [7,8], and most metrology software packages use this method to calculate the parameters of the associated surface. Nowadays, an apparatus and method for automatically identifying faults in the operation of a machine vision measuring systems provides an improved self-diagnostic capability for machine vision based metrology and tracking systems [9, 10].

The fitting of theoretical surfaces to a set of points consists in defining an initial position close to the optimum position so that the small displacements screw method can be used. The assumptions of this method require that the displacements are small and that the measuring surface has a low form error in comparison with the geometric error (orientation, position.).

In this paper, a non linear method is used. From the model of tolerancing proposed, it is possible to create a

virtual gauge for a better transcription of the functionality. This gauge represents the connecting interface of the part during the assembly of the mechanism.

2. METHODS OF TOLERANCING TOOLS AND THEIR IMPLICATIONS

In the tolerancing phase, the designer has tolerancing tools (straightness, flatness, perpendicularity, position...) and principles (maximum material requirement, envelope requirement ...). According to its choices, he can define the verification procedures of the toleranced parts in advance.

The envelope requirement applies in the many cases for which an assembly function is needed. The assembly (fitting) function is indeed transcribed by the requirement for a maximum material condition. The tolerancing with the maximum material condition may be classified in two types Fig. (1):

- a) **Type I:** Transfer of the diameter variation onto the geometric tolerance when the surfaces are in the maximum material virtual state. The datum surface and specified surface are the dimensional resources.
- b) **Type II:** Transfer of the diameter variation of the datum system onto the geometric tolerance

Tolerancing based on requirements directs the inspection towards the verification by a gauge [11,12]. It reconstructs the functional environment present in the assembled mechanism. The cost generated by the manufacturing of materiel gauges entails the suggestion to use virtual gauges based on computer simulation. The inspection is a binary process [13]. However some limits concerning the use of the maximum material condition can be noted here; when the type II is used is used, because no formulation exists at the level of design and verification that allows managing dimensional transfers onto the geometric tolerance [14].

*Address correspondence to this author at the Laboratory of Mechanics, Faculty of Engineering Sciences, Mentouri-Constantine University, Road of Ain-el-Bey, 25000 Constantine, Algeria; Tel/Fax: 00 213 31 81 88 53 / 63; E-mail: boukebbab@yahoo.fr

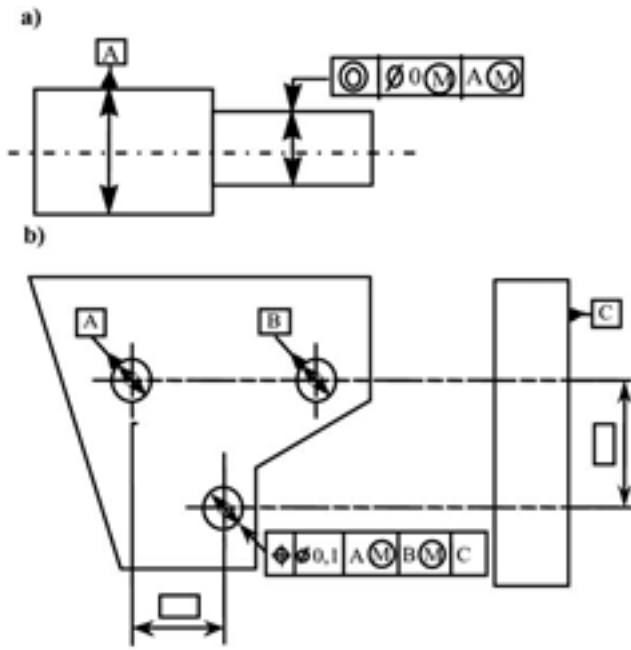

Fig. (1). Example for tolerancing with the maximum material condition, a) type I, b) type II.

Moreover, in the most recent releases of Coordinate Measuring Machines software, only the cases of type I transfers are implemented. The interfaces between two groups of surfaces for assembly often show freedom potentialities (clearance and variation of internal tolerancing). Neglecting the clearances in these interfaces results in increasing constrains of functional tolerancing. To conclude this paragraph we can show the existing relations between design and control according to the use of requirements Fig. (2).

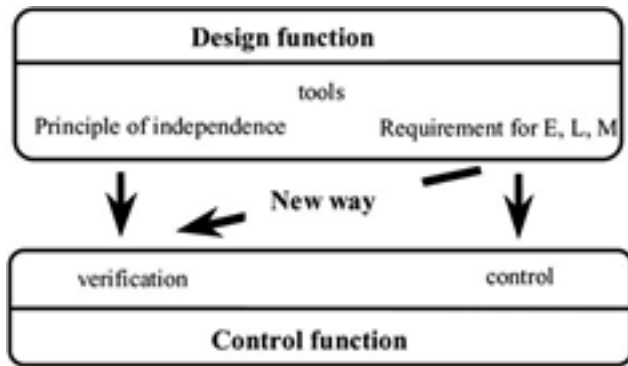

Fig. (2). Relation between design and control.

This illustration points up some failures in industry when physical gauges are replaced by a coordinate measuring machines which basically performs rather measurement than control in the present state of software. In [15] Methods for determining tolerances are disclosed that can be used for determining whether a lot of semiconductor wafers needs to be reworked.

3. EXAMPLE OF THREE-DIMENSIONAL TOLERANCING

To illustrate the management of dimensional transfers onto the geometric tolerance, the example presented in Fig. (3) is used.

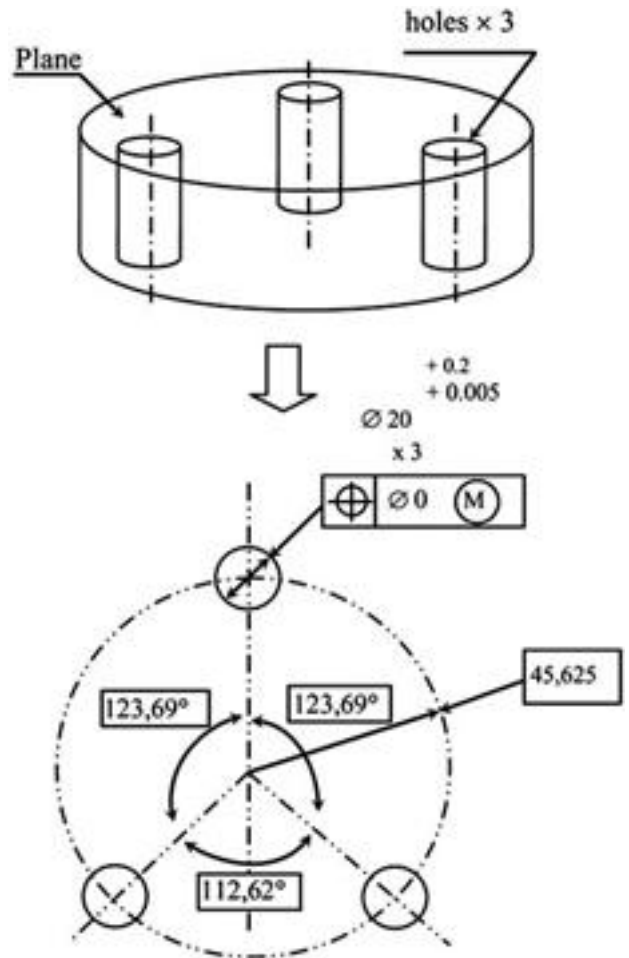

Fig. (3). Tolerancing suggested.

This specification can be classified in type II, because the three holes are specified in maximum state of matter. The conformity of the latter will be established by the verification process. A methodology for the control of this specification is proposed.

4. CONTROL FUNCTION

The inputs required for the verification procedure are files containing all the points M_i of the measured surfaces digitized in the measurement coordinate system and the parameters of the geometric specifications.

The vectors and the centers of the surfaces fitted to these points are first determined, in the measurement coordinate system after minimization of the deviations y_i between the digitized coordinates and the perfect geometric element Fig. (4).

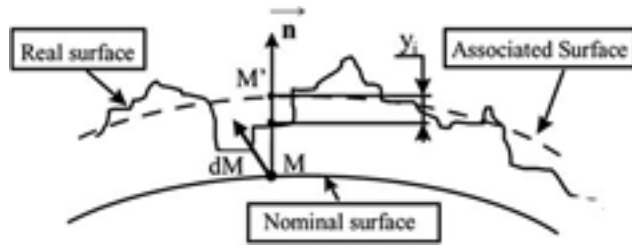

Fig. (4). Modeling of real surfaces.

The attributes of the fitted surfaces are finally obtained through a non linear least squares optimization [16].

4.1. The Large Displacements Method

As already pointed out, the actual coordinate measuring machine software's are based on an approximation of the deviations by a linear first order expansion. For that purpose each point of the ideal surface to be fitted to the acquired coordinates is moved iteratively from an initial position M to a transformed one M' , in order to reduce the deviations y_i Fig. (4). This displacement is obtained by three translations and three rotations. If it remains small, the displacement $dM = MM' = OM'OM$ can be modulated by a small displacement screw [17].

To satisfy this assumption, it is then necessary to move in a local co-ordinate system. This type of calculation requires as first step that the software estimates a position of the fitted surface close to the final solution. Then the optimization algorithm minimizes the "error function y_i " in several iterations. The result is then known in a local coordinate system. An inverse transformation (local co-ordinate system to global reference frame) gives the parameters of associated surface in the global reference frame [18]. The advantage of this method is that the equation to be minimized is easy to find for the matrix operation becomes a vector operation and the function is linear. The linearity of this equation allows obtaining y_i with a simplified optimization algorithm. In the seventies this characteristic had the advantage of reducing the calculation time of less advanced computers [19].

With the non linear method, the assumptions of infinitely small rotation angles and small displacement are no longer necessary. In our case, the equation of y_i is non linear but it offers the advantage of giving the results after optimization in the global co-ordinate system, and the calculated distance y_i does not undergo any approximation.

In the continuation of this article, the large displacement method will be used to model three cylindrical surfaces (holes) and a plane. Their virtual gauge will be constructed to test the conformity of the geometrical specification given in Fig. (3).

4.1.1. Modeling of Cylindrical Surfaces

Each measured point M_i with the coordinates $(x_j)_{j=1to3}$ is known in the coordinate system of the CMM's Fig. (5). The y_i equation becomes:

$$y_i = CM_i \cdot 1v \cdot R \quad (1)$$

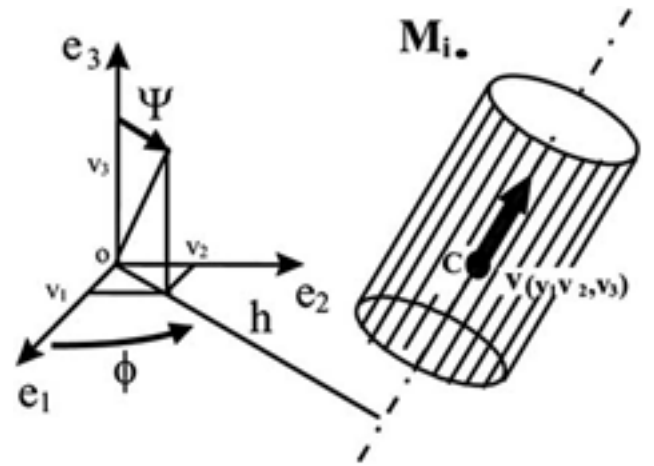

Fig. (5). Calculation of the distance y_i .

With v being the direction vector of the cylinder axis, C its characteristic point and R the radius of the cylinder.

To impose the normality condition of the direction vector n , this vector is defined in the cylinder coordinate system introducing two angles $(,1)$. The centre C of the axis is obtained by the projection of the centre of gravity of the measured coordinates to this axis. All the parameters are known in the global coordinate system $R_o(0, e_1, e_2, e_3)$. In this non-linear method, the distance y_i is not subjected to any approximation.

The optimization according to the least squares method enables us to identify the attributes of the fitted surfaces thanks to the following relation:

$$\sum_{i=1}^m y_i^2 = 0 \quad (2)$$

With i : number of digitized points

a_j are the optimization parameters

4.1.2. Modeling of the Plane Surface

The same treatment is carried out in the case of the plane surface. The attributes of the associated surface are calculated after optimization of the distance y_i Fig. (6).

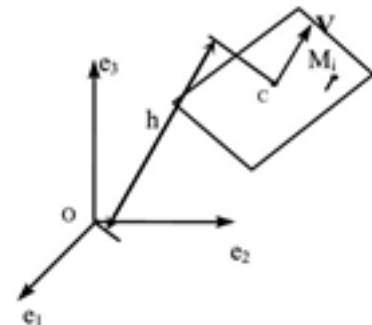

Fig. (6). Modeling of a plane.

In the same manner as for the cylinder, the plane is defined by its normal vector \mathbf{v} characterized in a cylindrical coordinate system and the distance h between the plane and the center O of the measurement reference frame.

It has to be pointed out, that with the least squares method, the center of gravity C of the measured coordinates belongs to the optimized surface. The defect y_i between the measured point and the associated surface is given by:

$$y_i = (\mathbf{OM}_i \cdot \mathbf{v}) - \frac{\sum_{k=1}^m y_i^2}{a} - h = 0 \quad (3)$$

With: $i=1$ to m digitized points

a_j are the parameters of optimization

5. CONTROL PRODEDURE

To be inline with the philosophy of « concurrent engineering », it is possible now to suggest a methodology for the control, for that, two possibilities have been explored:

- Control incorporated transfer flows of Type I and II
- Control or pairing with associated surfaces (level1)

The proposed control is called of level 1 since it integrates the same doubt because it is based on a set of points sampled onto the real surface. The necessary inputs for the control procedure are a file containing all the points M_i of the measured surfaces in the measurement referential system. The data of the assembled surfaces are necessary.

5.1. Building of the Reference System Linked to the Measured Part

The control starts with an acquisition stage of real surfaces. To this intent a « Trimesure 1004^E » coordinate measure machine (CMM) equipped with the latest release of the « Metromec » software, has been used. A pre-processing of the data retrieves a points file in the VDA format given by the machine software Fig. (7).

At the step of analyzing the measurements, the vectors \mathbf{v} and the characteristic points \mathbf{C} of the fitted surfaces are determined, in the measurement coordinate system. These attributes of the fitted surfaces are obtained through our non linear least squares optimization. For that purpose, the difference y_i between a given measured point and the associated surface is computed without any linearization.

The radius of the extreme fit cylinder is obtained by the sum of the radius R of the best fit surface and the maximal distance y_i between the best fit surface and the digitized points. The choice of maximal distance depends on the type of surface which is considered Fig. (8). When the surface is a shaft, the maximal distance increases the value of the best fit radius. For the hole, the radius of the extreme fit surface decreases.

After the step of treatment, the two cylinders closest to the maximum matter envelop (extreme fit) are known. These information permits to define the hierarchy of surfaces to be assembled [20].

ALESAGES - HEADER / 20		00001000
*****		00001010
VDAFS VERSION	: 2.0	00001020
-----ANGABEN UEBER DEN ABSENDER-----		00001030
SENDERFIRMA	: METROMEC SOFTWARE AG	00001040
ANSPRECHPARTNER	: ---	00001050
- TELEFON	: (081) 257 07 00	00001060
- ADRESSE	: COMMERCIALSTRASSE 20, CH-7007	
	CHUR, SCHWEIZ	00001070
ERZUEGENDES SYSTEM	: METROSOFT CM	00001080
ERZUEGUNGSDATUM	: 17.07.2002	00001090
SENDE-FILENAME	: A:\ALESAGES.VDA	00001100
-----ANGABEN UEBER DAS TEIL-----		00001110
PROJEKT	: ---	00001120
OBJEKTKENNUNG	: PIECE USINER: 14 ALSAGES	00001130
VARIANTE	: MESURE: 1 / ???	00001140
VERTRAULICHKEIT	:	00001150
GUELTTIGKEITSDATUM	:	00001160
-----ANGABEN UEBER/FUER DEN EMPFAENGER-----		00001170
EMPFAENGERFIRMA	: ---	00001180
EMPFAENGERART	: ---	00001190
*****		00001200
\$\$		00001210
\$1 = BEGINSET		00001220
\$\$		00001230
\$\$	1 / ???	00001240
\$\$		00001250
SIM1 = MDI / 24,		00001260
	414.5612, 307.0076, -194.3911, -0.0202, -0.0005, 0.998,	0001270
	414.5622, 219.3706, -194.4361, -0.0202, -0.0005, 0.998,	0001300
	399.0652, 219.3716, -194.7441, -0.0202, -0.0005, 0.998,	0001310
	399.0662, 244.0896, -194.7541, -0.0202, -0.0005, 0.998,	0001320
	399.0672, 278.1186, -194.7501, -0.0202, -0.0005, 0.998,	0001330

Fig. (7). Beginning of the VDA format file.

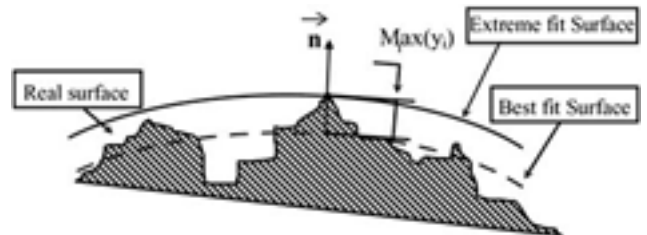

Fig. (8). Extreme fit surface for the shape of a shaft.

- C_1 will be the cylinder which is closest to the maximum matter condition;
- C_2 the cylinder which is closest to the cylinder C_1 ;
- C_3 the last.

After this stage, the coordinate system of the surface group is built according to the classification define before. In the present case, the primary axis (the axis Z_{FG}) is the axis associated with C_1 Fig. (9).

The second axis is supplied by the vector O_1O_2 (O_1, O_2 are the points of C_1, C_2 which intercept the theoretical plane P normal to C_1 and containing the highest point of P_1) Fig. (10). The third axis is defined by the vectorial product of the two previous vectors. The origin of the axis of the Functional

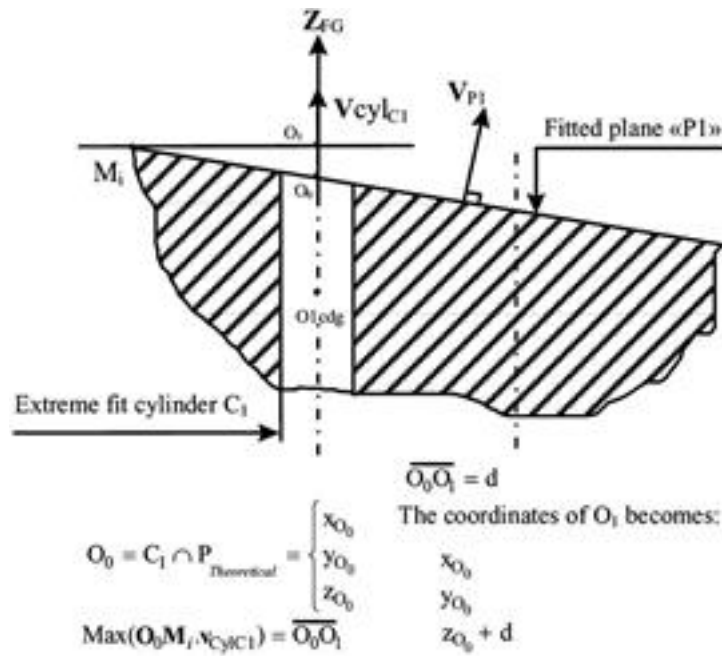

Fig. (9). Determination of the first axis.

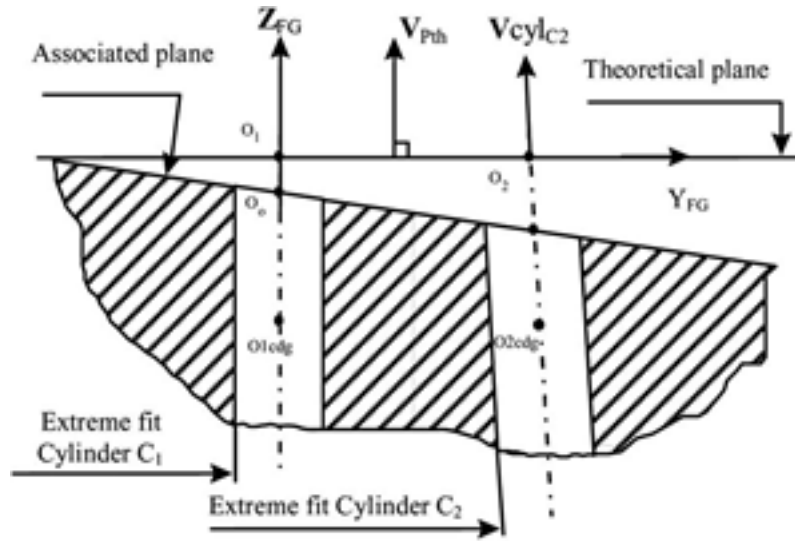

Fig. (10). Determination of the second axis.

Group (O_{FG}) is the intersection of axis Z_{FG} with a theoretical plane.

The configuration of Fig. (11) is obtained:

All the vectors of surfaces and the characteristic points (C_i) are then carried to the reference frame of the group surfaces. At this step, the control starts with the comparison of each diameter to its admissible limits.

5.2. Building of the Reference System Linked to the Gauge

The build information is proposed by the geometric specification imposed by the designer. The gauge surfaces are in maximum matter condition.

5.3. Control Procedure

In the first step of the control procedure, it is necessary to compare the diameters of extreme fit cylinders with their acceptable limits Fig. (12). The second control operation consists of finding an assembly case for which the intersection between the ends/extreme fit of the associated cylinders of both surface groups with the cylinders of the virtual gauge does not exist.

The search for the assembly case, made possible by the freedom space, is operated by statistical exploration of its domain. Two cases arise:

- No intersection, then the assembly is possible,

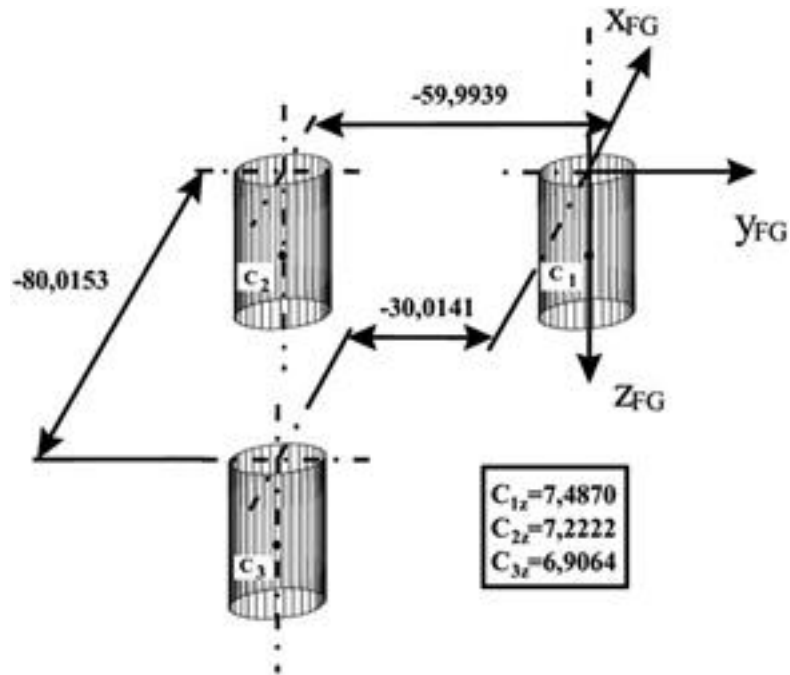

Fig. (11). Configuration obtained after optimization.

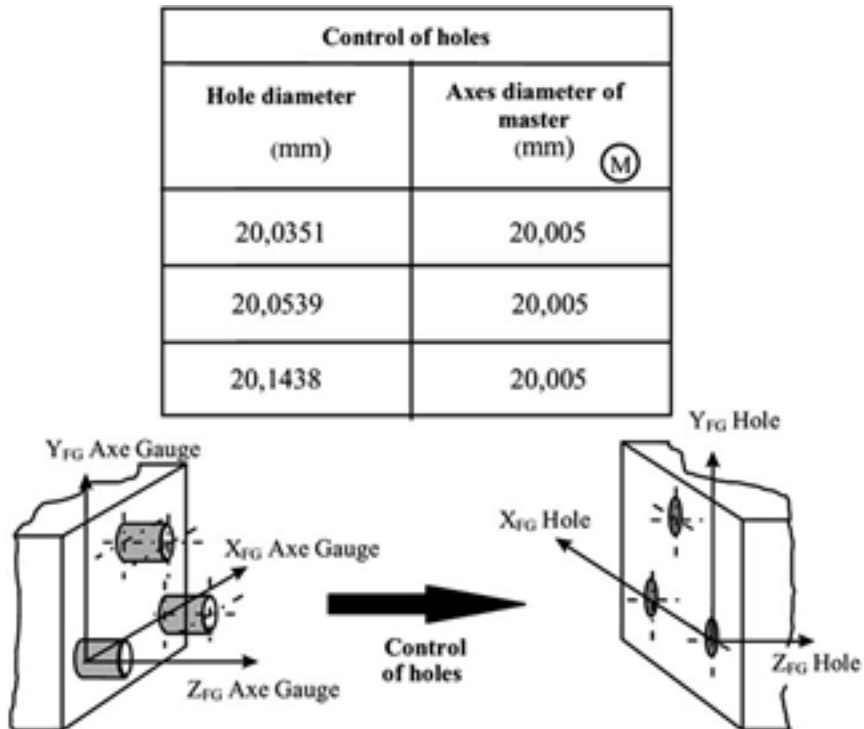

Fig. (12). Control of holes.

- Existence of an impossible intersection thus assembly.

The procedure of assembly imposes a hierarchy between assembled surfaces.

The first case does not pose a problem. In the second case, the statistical exploitation of the space of freedom, enables us to move the reference frame of the virtual gauge

compared to that of the group of surfaces until there is a possibility of assembly Fig. (13).

This space of freedom is a function of the existing clearance J_1 between C_1 and C_{1Gauge} is assumed to be lower than the clearance J_2 between C_2 and C_{2Gauge} , and it's generated in a three-dimensional volume modelled by the 5

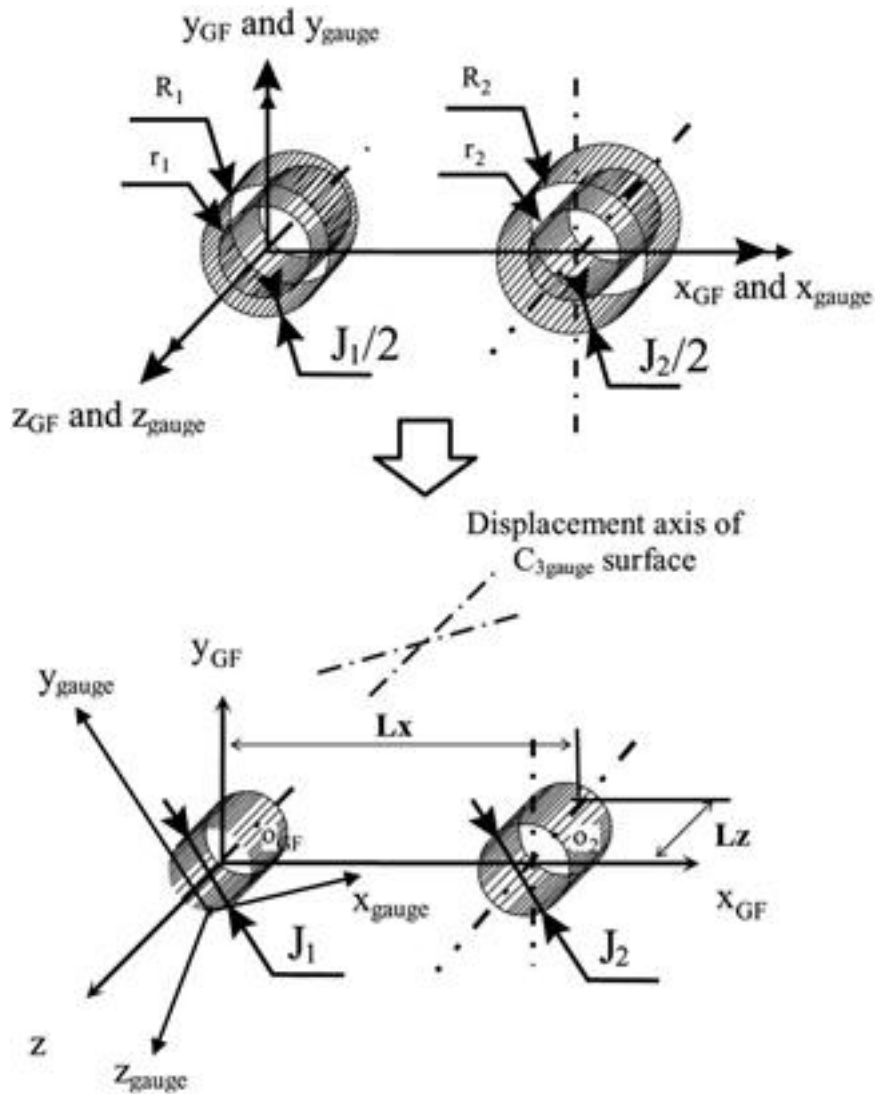

Fig. (15). Topology parameters.

Confronted with the complexity implicit equations which are difficult to solve analytically two treatments may be used:

- An analytic treatment: The implicit equations are very complex and difficult to solve
- An statistic treatment by a Monte Carlo method

The Monte Carlo simulation method has been published in many papers and books. It is well adapted to solve problems which depend on a great number of independent variables. In our single example, the number of internals and externals variables is greater than 10 Fig. (16).

Generally, all of the items of interest in these situations can be written in the form of equations, usually of considerable complexity and rarely amenable to explicit solution. The usual approach for handling these situations is the simulation.

The Monte Carlo method impose the knowledge of the distribution laws of each independent variable. It should be

evident that although the mathematical definition of randomness can be precise, the practical definition (Rnd function) depends on the software and the application. A number of criteria have been proposed for judging the quality of these generators (serial correlations of the pseudo random generator).

Such **Rnd** function should have has some qualities:

- **Stability.** The generator should pass all the statistical tests and have an extreme long period.
- **Efficiency.** Its Execution should be rapid and the storage requirement minimal
- **Repeatability.** A fixed starting condition (Randomize function) should generate the same sequence.
- **Simplicity.** The algorithm should be easy to implement and use.

A demonstration software has been developed. At each iteration, a new position of the axis of cylinder C_3 (or $C_{3\text{gauge}}$) is calculated. After a great number of simulations, all the

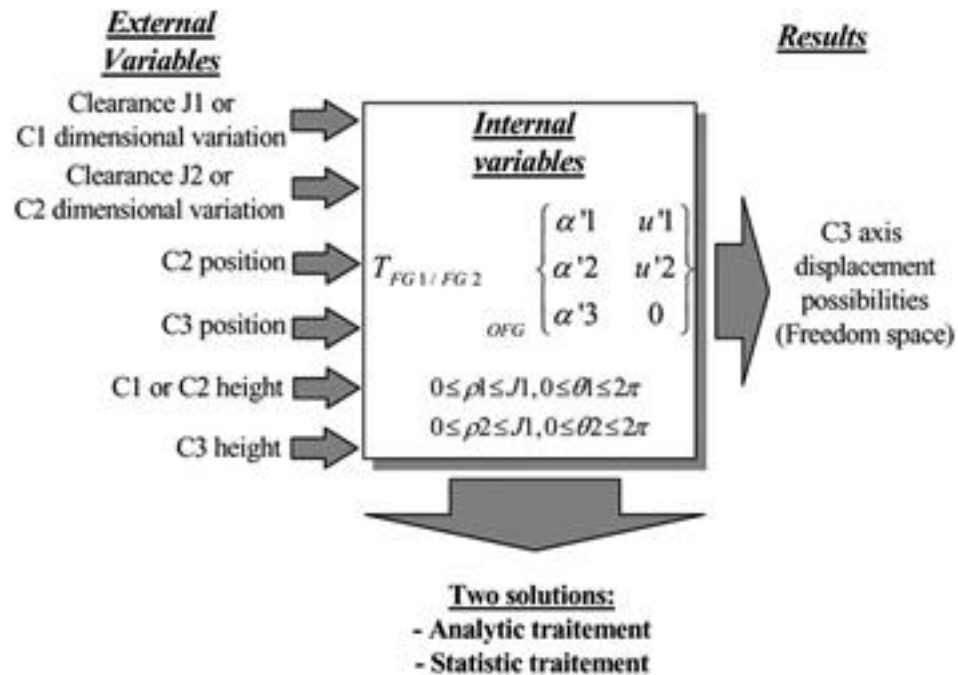

Fig. (16). External and internal variables.

possible displacements of these axis C_3 (or $C_{3\text{gauge}}$) can be plotted Fig. (17). The boundary of the domain which is thus obtained represents the freedom space of C_3 (or $C_{3\text{gauge}}$).

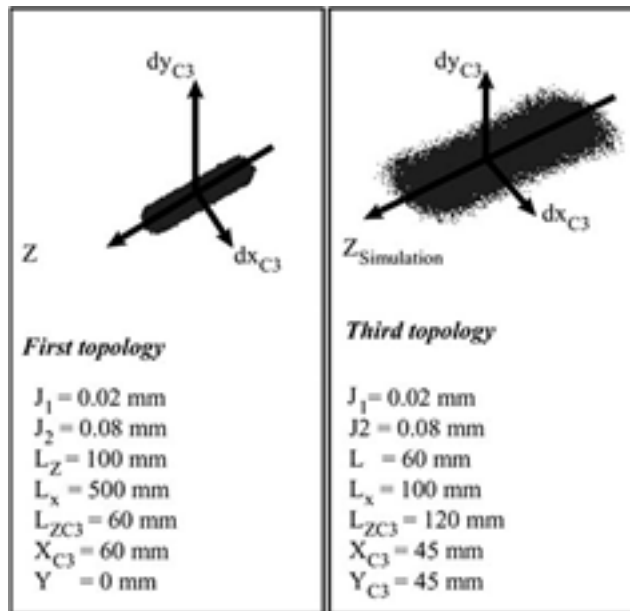

Fig. (17). Some simulations results.

The research of the case of assembly, made possible by the space of freedom, is carried out by a statistical exploration of its field. This research does not present any difficulty of calculation, because simulation information of the assembly is of a great flexibility in use.

This methodology makes pairing possible between two Functional Groups represented by their mathematical images/extreme fits. We can either perform control between the computer gauge and the associated surfaces of one Functional Group or between the associated surfaces of two Functional Groups.

6. CURRENT & FUTURE DEVELOPMENTS

The maximal material condition has an extent use in the geometric specification of the mechanical parts. It permits to specify the fitting condition. When the datum references or the specification use this requirement, it is very difficult to verify the geometrical specification.

This paper focuses on the verification of this type of specification by virtual gauge. This proposition is based on the freedom space. It permits to control the displacement possibilities of the gauge onto the part. The determination of the freedom space necessities the accuracy of the surface parameters.

The no linear calculation permits to obtain these parameters directly in the global reference frame associated at the coordinate measurement machine. With these parameters it is possible to calculate the maximal material states of the surfaces. These indications permit to define the clearances between the virtual gauge and the extreme fits of the surfaces. The values of the clearances permit to calculate the freedom space. It defines the displacement possibilities of the gauge onto the part. The displacements permit to assembly the gauge with the part when the assembly is possible. This procedure is never possible with the requirement of the minimal material condition. In this case only the use of virtual gage is possible.

REFERENCES

- [1] Grupp, G., Kammleiter, B.: US20080177491 (2008).
- [2] Wen-Yuh J, Chien-Hong L, Cha'o-Kuang C. The min-max problem for evaluating the form error of a circle. *Measurement* 1999; 26: 273-282.
- [3] Jiing-Yih L, Wen-Der U. Reconstruction of surfaces of revolution from measured points. *Comput Industry* 2000; 41: 147-161.
- [4] Sprauel JM, Linares JM, Bourdet P. Contribution of nonlinear optimization to the determination of measurement uncertainties. *In Proc of the seventh CIRP seminar on computer-aided tolerancing*, Cachan, France 2001; 285-291.
- [5] Antony GT, Anthony HM, Bittner B, *et al.* Reference software for finding Chebyshev best fit geometric elements. *Precision Eng* 1996; 197: 28-36.
- [6] Bourdet P, Mathieu L, Ballu A. The concept of the small displacement taylor in metrology, *Advanced Mathematical Tools in Metrology II*, World Scientific Publishing Company 1996; 110-122.
- [7] Goch G. Gear metrology, *Keynote papers. Ann CIRP* 2003; 52 (2): 1-37.
- [8] Jackson, D., Shroff, H., Christian, D.J., Glickman, S.: WO0146909 A1 (2001).
- [9] Asme Y. Dimensioning and tolerancing. The American Society of Mechanical Engineers, New York 1994.
- [10] Boukebbab S, Bouchenitfa H, Boughouas H, Linares JM. Applied iterative closest point algorithm to automated inspection of gear box tooth. *Int J Comput Indus Eng* 2007; (52), 162-173.
- [11] Etesami F. Position tolerance verification using simulated gaging. *Int J Robot Res* 1991; 10 (4): 358-370.
- [12] Robinson DM. Geometric tolerancing for assembly with maximum material parts, in: *CIRP Seminar on Computer Aided Tolerancing*, Toronto, Canada, April 1997.
- [13] Dantan JY, Ballu A. Assembly specification by gauge with internal mobilities: A specification semantic deduced from the tolerance analysis. *J Manuf Syst* 2002; 2(3): 218-235.
- [14] Mailhe J, Linares JM, Sprauel JM, Bourdet P. Geometrical checking by virtual gauge, including measurement uncertainties. *CIRP Ann Manuf Technol* 2008; 57 (1): 513-516.
- [15] Sturtevant, J.L., Gu, Y.: US20087349752B1 (2008).
- [16] Linares JM, Boukebbab S, Sprauel JM. *Parametric tolerancing, 6th CIRP Int seminar on Comp Aided Toleranc.* University of Twente, Enschede, The Netherlands, Mars 1999; 167-176.
- [17] Bourdet P, Clement A. A study of optimal-criteria identification based on the small displacement screw model. *Ann CIRP* 1988; 37: 503-506.
- [18] Sprauel JM, Linares JM, Bourdet P. Contribution of non linear optimization to the determination of measurement uncertainties, selected papers book of the Computer Aided Tolerancing CIRP, *Geometric specification and verification: Integration of functionality* ed Pierre Bourdet et Luc Mathieu, Kluwer Academic Publisher 2003; 237-244.
- [19] Pairel E. Three-dimensional verification of geometric tolerances with the "Fitting Gauge" Model. *J Comput Inform Sci Eng* 2007; 7(1): 26.
- [20] ISO TS 17450-1, Geometrical product specification, General concepts, Part 1: Model for geometric specification.