



**HAL**  
open science

## **Fatigue effects of marathon fatigue on neuromuscular performance. I. Changes in muscle force and stiffness characteristics**

Caroline Nicol, P V Komi, P Marconnet

### ► **To cite this version:**

Caroline Nicol, P V Komi, P Marconnet. Fatigue effects of marathon fatigue on neuromuscular performance. I. Changes in muscle force and stiffness characteristics. *European Journal of Applied Physiology*, 1991. hal-01644857

**HAL Id: hal-01644857**

**<https://amu.hal.science/hal-01644857>**

Submitted on 22 Nov 2017

**HAL** is a multi-disciplinary open access archive for the deposit and dissemination of scientific research documents, whether they are published or not. The documents may come from teaching and research institutions in France or abroad, or from public or private research centers.

L'archive ouverte pluridisciplinaire **HAL**, est destinée au dépôt et à la diffusion de documents scientifiques de niveau recherche, publiés ou non, émanant des établissements d'enseignement et de recherche français ou étrangers, des laboratoires publics ou privés.

# Fatigue effects of marathon running on neuromuscular performance

## I. Changes in muscle force and stiffness characteristics

Nicol C, Komi PV, Marconnet P. Fatigue effects of marathon running on neuromuscular performance. I. Changes in muscle force and stiffness characteristics. *Scand J Med Sci Sports* 1991; 1: 10-17.

Nine experienced endurance runners performed individual marathon runs that involved several tests of neuromuscular performance before, during and after the marathon. The tests were performed with special force platform and dynamometer techniques. The results showed an overall decrease in performance from the marathon. The maximal sprint velocity decreased parabolically during the marathon, reaching the final value of 84% of the pre-marathon one. Similarly, the other test results after marathon indicated that maximal isometric knee extension torque was 78%, the performance in a special rebound test (drop jump) 84% and the 5-jump performance 92% of the pre-marathon values. These reductions were accompanied by alteration in the ground reaction force curves in the sprint and jump tests, suggesting reduced tolerance to stretch load as well as loss in the recoil characteristics of the muscles.

**C. Nicol<sup>1</sup>, P. V. Komi<sup>1</sup>, P. Marconnet<sup>2</sup>**

<sup>1</sup>Department of Biology of Physical Activity, University of Jyväskylä, Finland, <sup>2</sup>Laboratory of Biomechanics and Biology of Exercise, Nice, France

**Key words:** muscle; fatigue; force production; stiffness and stretch-shortening cycle

Caroline Nicol, Department of Biology of Physical Activity, University of Jyväskylä, PL35, SF-40351 Jyväskylä, Finland

Accepted for publication November 22, 1990

Repeated stretch-shortening cycle (SSC) exercises induce fatigue that is likely to affect force production both in isometric and dynamic type performances. In fact, force reduction has been demonstrated in prolonged exercises of primarily aerobic type such as 85-km skiing race (1) or marathon running (2) as well as in shorter periods of intensive repetition with the arm muscles (3). Because of the successive stretching loads, the decreased performance may result partly from alterations in stiffness regulation. Thus, repeated and fatiguing SSC efforts may modify neuromuscular behavior so that, depending on the test load, the regulation either increases the muscle stiffness or favors damping mechanisms. These changes may be specifically reflected by disturbances in the interaction person-(shoe)-surface. To investigate further the effects and adaptations induced by this type of fatigue, we examined the short-term influences of a marathon race. The run was performed individually in a research situation, simulating as closely as possible a real competitive race. The parameters covered several aspects of neuromuscular functioning. This report deals primarily with the force production measured by the dynamometer and force platform techniques.

### Material and methods

#### Subjects

One woman and 8 men volunteered for this study. They all had experience in regional-level competition in marathon and/or triathlon. The range of their personal best times of the season was from 2 h and 30 min to 3 h. Table 1 presents the sport specialty and the physical characteristics of the subjects.

#### Experimental design

The experimental design comprised 2 testing sessions, day 1 and day 2, separated by a period of 4 days (Table 2). The present report deals primarily with the tests indicated by an asterisk in Table 2.

Day 2 was the actual running and testing day after a control and learning session (day 1). Force production was measured through jumping and strength tests. Both were performed immediately before marathon and repeated so that the jumping tests were taken immediately and the strength tests 40 min after the marathon. One sprint running was performed at the beginning and after every 10 km.

Because of the complexity of the measurements, the race had to be run individually. Thus, the average marathon speed was chosen for each runner on the basis of his or her actual training state

Table 1. Physical characteristics of the subjects

Subject	Specialty	Sex	Age (years)	Weight (kg)	Height (cm)
1	marathon	M	32	59.0	171
2	marathon	M	34	66.7	180
3	marathon	M	29	65.0	174
4	marathon	M	31	58.9	168
5	marathon	M	32	58.7	179
6	triathlon	M	35	72.8	175
7	triathlon	M	31	74.6	188
8	triathlon	M	28	93.0	190
9	triathlon	F	20	53.4	168
Mean			30.2	66.9	177
(±SD)			(±4.4)	(±12)	(±8)

and last competitive performance. During the marathon, the selected speed was continuously shown by a cyclist pacing the runner. In a real competition situation, however, the levels of motivation performance and consequently fatigue might have been higher.

Testing and measurement

The maximal isometric torque of the left knee extensors was measured with a special knee extension dynamometer (David Rehab System). The knee and hip joints were respectively at 120° and 110°.

When the subject sat on the dynamometer, special care was taken to align the knee flexion-extension axis with the lever axis of the dynamometer.

The correct position was obtained for each subject by adjusting the lengths of the seat and leg lever. A counterweight was also individually adjusted at the opposite extremity of the leg lever to compensate for the weight of the leg. The position was secured with 3 belts set around the hips and the left thigh and ankle. The measurements were written down to secure the same position in the postmarathon test.

On day 1, the subjects performed a series of 3 trials separated by 30 s, from which the first effort was submaximal (80%) and the other 2 maximal. On day 2, a single trial was performed immediately before marathon and repeated 40 min after the race. The maximal contractions were performed as quickly as possible on the experimenter's command. The subjects were instructed to maintain their maximal effort until the auditory signal given 3 s after the initial command.

The forces exerted on the leg lever were detected by strain gauges set in the lever itself. The obtained torque signals were recorded onto a magnetic tape (Racal store 14). The torque levels reached were read from a graphic plotter (Servotrace) that was set in parallel with the magnetic tape recorder. The maximal torque value of each runner on day 1 was used to control whether the subject performed maximally in the pre-marathon trial. The latter test was limited to 1 maximal action only, to avoid possible risk. This was also the wish of the subjects.

The maximal sprint and 5-jump tests were performed over a special 7.40-m force platform sys-

Table 2. Chronologic presentation of the tests performed on day 1 and 2

	Day 1 (4 days before marathon)		Before marathon		Day 2 During marathon						After marathon	
	TT ProgMax	DDT *IsomMax Endurance	TT 3SP	DDT *Isom- Max	0 km	10 km	20 km	30 km	42 km	TT 3SP	TT 3SP	DT *IsomMax Endurance
Laboratory tests												
Tests on the track		FPT *CMJ *DJ *5J		FPT *CMJ *DJ *5J *SP	FPT MR	FPT MR *SP	FPT MR *SP		FPT MR *SP	FPT MR	FPT *SP *CMJ *DJ *5J	

- TT treadmill tests
- DDT David dynamometer tests
- FPT force platform tests
- ProgMax progressive and maximal
- 3P 3 successive speeds
- \*IsomMax maximal isometric torque
- Endurance isometric endurance
- \*CMJ counter movement jump
- \*DJ drop jump
- \*5J 5 forward jump series
- \*SP maximal sprint
- MS marathon speed running

(\* tests included in this report)

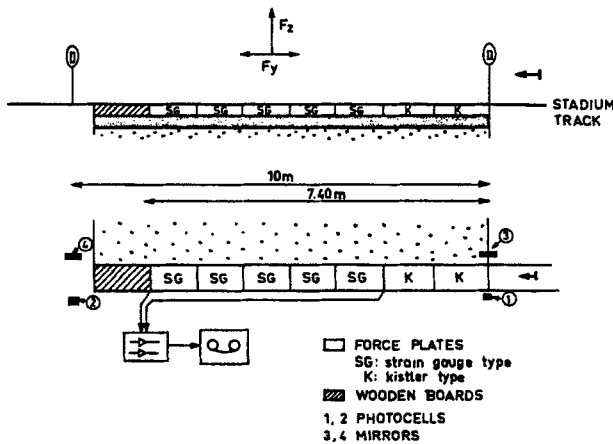

Fig. 1. Schematic description of the force platform and time-measuring device (photocells).

tem (Fig. 1). The system consisted of 7 individual force plates, 2 Kistler-type (0.60 × 1.20 m) and 5 strain gauge-type (0.60 × 1.00 m) connected in series, covered with a tartan mat and levelled with the stadium track. Each force plate registered both vertical ( $F_z$ ) and horizontal ( $F_y$ ) as well as lateral ( $F_x$ ) components of the ground reaction force. From these, only  $F_z$  and  $F_y$  signals were stored on a magnetic tape recorder (Racal 14) for further analysis with a microcomputer system (Victor-Sirius). To get adequate conversion rates, the minimum sampling in the analysis was set at 500 Hz.

The maximal sprints were measured after 20 m of acceleration before the force plates. This should have ensured that the maximal speed was reached before the long force platform. The subjects were asked to maintain the maximal speed all along the 10 recorded meters, which extended over the force plates.

The battery of jumping tests included 2 different vertical jumps: counter movement jumps (CMJ) and drop jumps (DJ), followed by a 5-forward-jump series (5J). In CMJ trials, the subjects started from an erect standing position on a Kistler force plate and jumped vertically after a preparatory counter movement. In DJ trials, each vertical jump was preceded by a drop on a Kistler force plate from a height of 50 cm. The subjects were asked to jump upwards after the first impact without any delay on the force plate. Following the procedures in the study of Komi & Bosco (4) for CMJ and DJ tests, they were instructed to keep their hands on the hips throughout the entire movement. In addition, the hip extension was minimized in both tests. This was primarily done to measure the performance of the leg extensor muscles. To minimize lateral and horizontal displacements during the jumps, the subjects were also

asked to take off and land in the same place and position.

In the 5J test, the subject started from a standing position and tried to cover the longest distance by performing a series of 5 forward jumps with alternative left and right leg contacts.

#### Data processing

The torque signal recorded during the maximal isometric tests was digitized with a sampling frequency of 1 kHz. The torque-time curve of every trial was smoothed 8 times (4 returns) by the running averaging of every 20 successive points. The smoothing did not shift the signal, but took the high frequency noise away. The maximal torque was then measured for the first 2500 ms after the start of the tension recording. For quantitative analysis of the torque-time response, the first 1900 ms were integrated and averaged for 19 successive 100-ms periods. The time needed to reach successively the torque levels of 10%, 20%, 30% ... 100% of the maximal torque developed before and after marathon by each subject was also determined. The individual values were then averaged at the selected relative torque levels for a pre-post marathon comparison.

Every sprint over the force platform system included 2–3 contacts. The vertical and horizontal force signals were first digitized with a sampling frequency of 1250 Hz. Two successive contacts were always summed for analysis using a trigger signal of + 25 mV of the early force recording. The obtained individual force-time curves were then filtered with the cut-off frequency at 60 Hz. The horizontal force-time record was used to separate both  $F_z$  and  $F_y$  components into braking and push-off phases.

The integrals of both force-time curves were calculated for the whole contact duration and for its respective braking and push-off periods. This computation gave the net impulse for each period, which was then divided by the respective contact time to obtain the average force ( $\bar{F}$ ).

To compare the form of the  $F_z$  and  $F_x$  force-time curves at various measurement points during the marathon, a group-averaging technique was employed. In this procedure, the  $F_z$  and  $F_y$  force-time curves were respectively summed using a trigger signal set as previously.

The 5J records included also 2–3 contacts on the force platform. In this case, the  $F_z$  and  $F_y$  signals were sampled at a 2 kHz frequency and both force-time curves of 2 successive ground contacts were respectively summed. The methods used to sum together the curves and to integrate the different

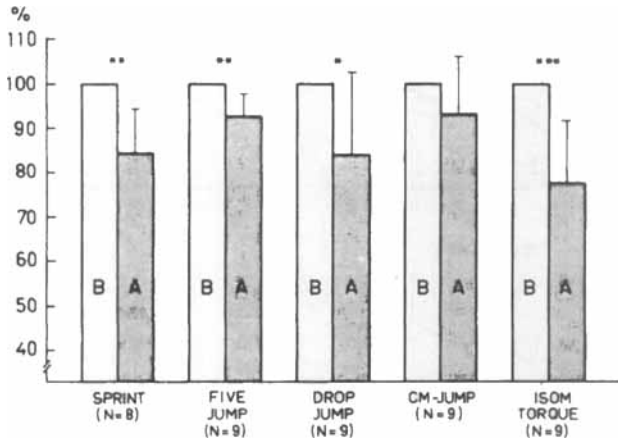

Fig. 2. Relative changes in the before-after marathon comparison of the maximal running, jumping and isometric performances. Sprint: 10 m sprint after 20 m acceleration. Five jump: 5-jump series. Drop jump: drop jump from a 50 cm height. CM-jump: counter movement jump. Isom Torque: isometric torque of the left knee extensor muscles. \* $P < 0.05$ ; \*\* $P < 0.01$  \*\*\* $P < 0.001$  in before-after marathon comparison.

periods were the same as those described above for the sprint analysis.

Both CMJ and DJ tests included 2 trials. In each case, the jump with the longest flight was selected and sampled at 500 Hz. The flight time ( $t$ ) allowed the calculation of the height of rise of the center of gravity. The representative force-time curve for the group was obtained by summation using a trigger signal set at the exact rise of the force recording.

Ordinary statistical procedures were employed to calculate mean, standard deviation and paired two-tailed  $t$ -test values. Linear and nonlinear regression analysis was also performed in some

cases. The level of statistical significance was set at  $P < 0.05$ .

Results

In 4 parameters of 5, the post-marathon values for maximal performance were significantly lower than the pre-marathon ones (Fig. 2). The sprint velocity was reduced by as much as  $15.7 \pm 10\%$  ( $P < 0.01$ ) from  $9.3 \pm 2$  to  $7.9 \pm 1.5 \text{ ms}^{-1}$ . Similarly, the 5-J performance decreased by  $8.3 \pm 4.7\%$  ( $P < 0.01$ ) from  $10.2 \pm 1.1$  to  $9.4 \pm 0.8 \text{ m}$ . In the DJ test, the height of rise of the center of gravity decreased by  $16 \pm 18.4\%$  ( $P < 0.05$ ) from  $28.6 \pm 3$  to  $23.7 \pm 7 \text{ cm}$ . The CMJ performances did not change significantly. In the test of maximal isometric strength, the maximal torque value declined greatly by  $22.3 \pm 14\%$  ( $P < 0.001$ ) from  $416.4 \pm 104$  to  $330.2 \pm 115 \text{ Nm}$ .

The 22% decrease of the maximal isometric torque production (Fig. 2) was associated with a significant change in the shape of the torque-time curve. After marathon, the subjects needed significantly more time than before to reach the respective levels of 80% and 90% of their actual maximal isometric torque (Fig. 3a). There were no intraindividual differences in the time needed before and after marathon to reach the maximal torque level (100%). However, when expressed in absolute value, the post-marathon average torque remained always reduced compared with the pre-marathon one at either  $P < 0.01$  or  $P < 0.001$  after the first 100 ms of the contraction (Fig. 3b).

The maximal sprint velocity decreased parabolically ( $P < 0.001$ ) during the marathon (Fig. 4). The final post-marathon velocity was  $84.3 \pm 10\%$

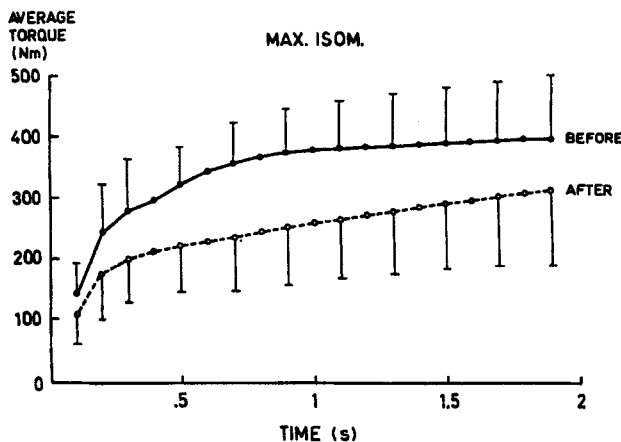

Fig. 3A. Group-averaged torque-time curves recorded before (—) and after (---) marathon. The curves are significantly ( $P < 0.01$ ) different beginning at 0.2 s.

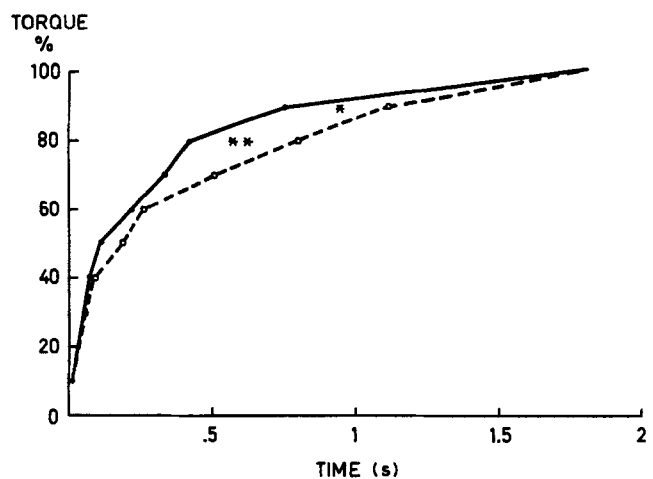

Fig. 3B. Before and after marathon recordings of the average torque-time curves of the isometric knee extension torques in the relative scale. \*\* $P < 0.01$  between the times to reach 80% torque level; \* $P < 0.05$  between the times to reach 90% torque level.

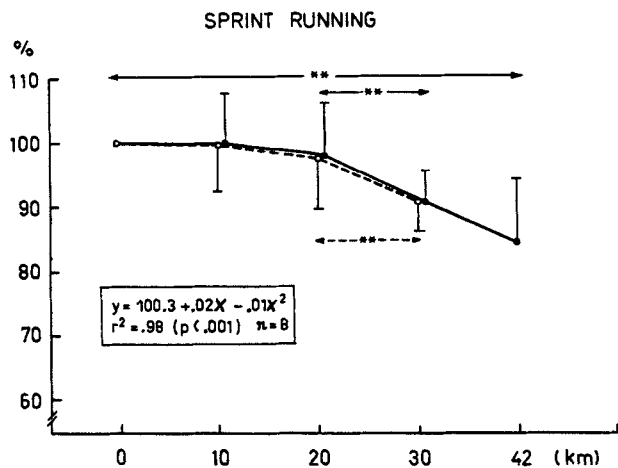

Fig. 4. Relative change of the average maximal velocity of the sprint performed before marathon and repeated every 10 km during the marathon. The mean values were obtained from the individual ones already expressed as a percentage of the pre-marathon performance (before = 100%). ---: averaged curve for the 9 runners; —: averaged curve for 8 of the runners. \*\* $P < 0.01$  between 2 different moments of sprint test along the marathon race.

( $P < 0.01$ ) of the pre-marathon one. Especially significant ( $P < 0.01$ ) was the reduction after the 20th kilometer (Fig. 4).

When the Fz and Fx records of the successive sprints performed during the course of the marathon were compared with the pre-marathon ones, the following significant changes were noticed:

The average vertical force of the braking phase was lower in the sprints recorded at 30 km and at 40 km, decreasing from  $1776 \pm 391.4$  kN to (respectively)  $1479.5 \pm 298.6$  kN ( $P < 0.05$ ) and  $1562 \pm 340.4$  kN ( $P < 0.01$ ). In the tests during the marathon, the average horizontal force of the

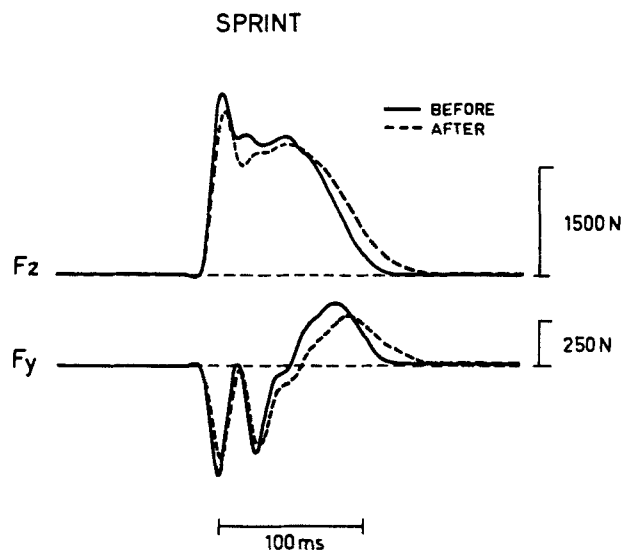

Fig. 5. Group-averaged vertical (Fz) and horizontal (Fy) ground reaction force curves of 2 successive sprint contacts recorded before and after marathon.

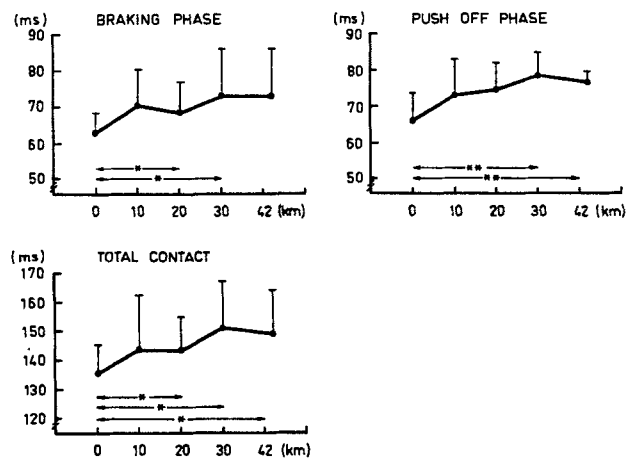

Fig. 6. Duration (mean  $\pm$  SD) of the different ground contact phases (braking, push-off and total) of the sprint runs during the marathon. \* $P < 0.05$ ; \*\* $P < 0.01$  between the values measured in the pre-marathon test and along the race.

push-off phase progressively declined from  $206.5 \pm 46.3$  kN as follows: 20 km:  $182.3 \pm 46.5$  kN ( $P < 0.01$ ); 30 km:  $178.1 \pm 50.5$  kN ( $P < 0.05$ ); and 42 km:  $174 \pm 58.8$  kN ( $P < 0.001$ ) (Fig. 5).

A detailed time analysis of the ground contacts revealed statistically significant increases in the total contact time as well as in the respective braking and push-off phases (Fig. 6). The changes were especially large for the push-off phase.

The reduced performance in 5J reflected various decreases in the Fz force components (Fig. 7). The vertical force impulse declined from  $377 \pm 126$  to  $318 \pm 119$  N.s ( $P < 0.01$ ) (Fig. 8). The reductions in the impact peak and maximal force values were from  $3040 \pm 832$  to  $2107 \pm 594$  N ( $P < 0.01$ ) and from  $2552 \pm 575$  to  $1813 \pm 532$  N ( $P < 0.01$ ) respectively (Fig. 8). A great decrease was noticed in the average vertical force from  $1461 \pm 334$  to  $1274 \pm 342$  N ( $P < 0.001$ ). A specific reduction occurred in the braking phase of the contact from  $1815 \pm 413$  to  $1460 \pm 440$  N ( $P < 0.001$ ) (Fig. 9).

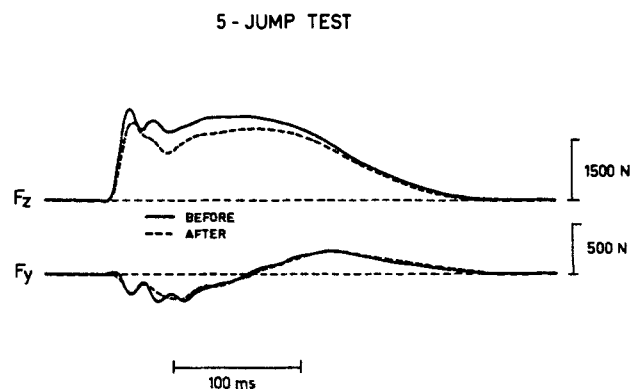

Fig. 7. Group-averaged vertical (Fz) and horizontal (Fy) ground reaction force curves recorded before (—) and after marathon (---) in the 5-jump test.

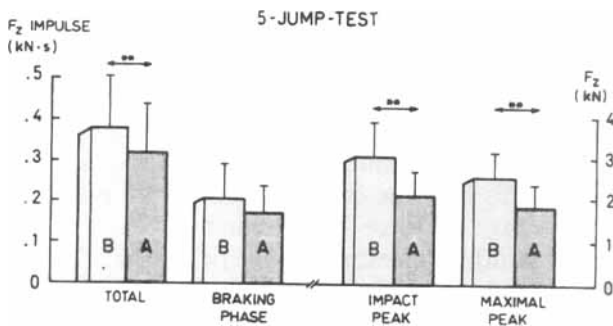

Fig. 8. Before-after marathon comparison of the Fz impulse (total contact and braking phase) and Fz peak value (at impact and during the rest of the contact) of the 5-jump test. \*\* $P < 0.01$ .

The lower rise of the center of gravity in the drop jump resulted from a shorter flight duration, which changed from  $482.30 \pm 25$  to  $436 \pm 63$  ms ( $P < 0.05$ ). The qualitative comparison of the groupaveraged force-time curves recorded before and after marathon shows both higher force impact peak and successive decrease in force (Fig. 10).

**Discussion**

This marathon race reduced the maximal force and slowed the rate of force development. This has already been observed in fatigue loads with isometric (5), concentric (6) and eccentric actions (7) as well as in SSC-type fatiguing exercises (3). After a prolonged cross-country skiing race (5–9 h) a 10% reduction in maximal isometric force was associated with a 22% slowing of the maximal rate of force development (1). In a marathon study (8), the immediate post-race level of the maximal peak torque was 64.5% of the pre-marathon one. The reduced strength performance continued 1 d after the marathon and the recovery did not take place before the following 5–7 d.

It may be attractive to explain the loss of force production capacity by the simple terms of “central” and “peripheral” fatigue. These types of fatigue mechanisms have been differentiated (9–11). This study was not, however, designed to examine these phenomena specifically. At present, it is speculated that both of these mechanisms operated, but the discussion focuses on the peripheral one (at muscle level), which is thought to have dominated.

The running and jumping tests used here cause muscles to function primarily in SSC. The marathon running modified SSC performance (Fig. 2), which is known to depend on the use of stored elastic energy of the eccentric phase and also to be under the possible influence of stretch reflex potentiation (12,13). Since the degree of potentiation depends on the ability to tolerate and use stretch

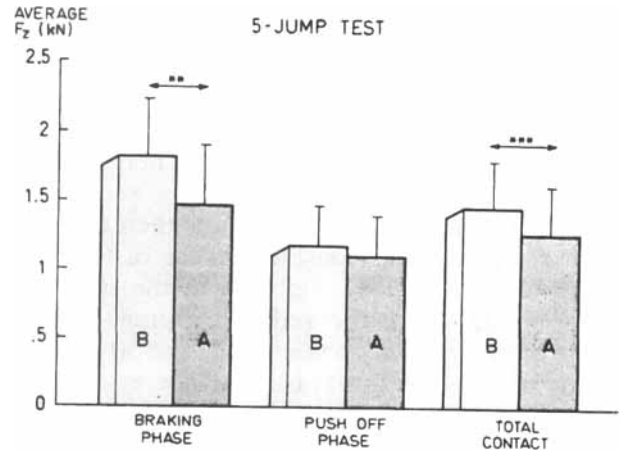

Fig. 9. Changes in the before-after marathon comparison of the group-averaged vertical force (Fz) of the respective braking and push-off phases as well as total contact period in 5-jump test. \*\* $P < 0.01$ , \*\*\* $P < 0.001$ .

loads, it seems of special interest to examine the possible alterations induced by the marathon in the characteristics of the ground-reaction force curves of the different performances.

In such a situation, Komi et al. (2) previously observed that the capacity to tolerate impact forces appeared to deteriorate by the repetitive impact loads of the marathon run. Both sprint and 5J performances after marathon had a significantly decreased average vertical force in the braking phase. This reduced tolerance was seen in the average curves by a fast drop in the vertical force observed after the impact peak in both sprint (Fig. 4) and 5J (Fig. 7) as well as in DJ tests (Fig. 10). Gollhofer et al. (3) suggested that, in the fatigued state, the high initial force peaks are less absorbed by the tendomuscular system. The reduced damping observed in 5J performance is therefore note-

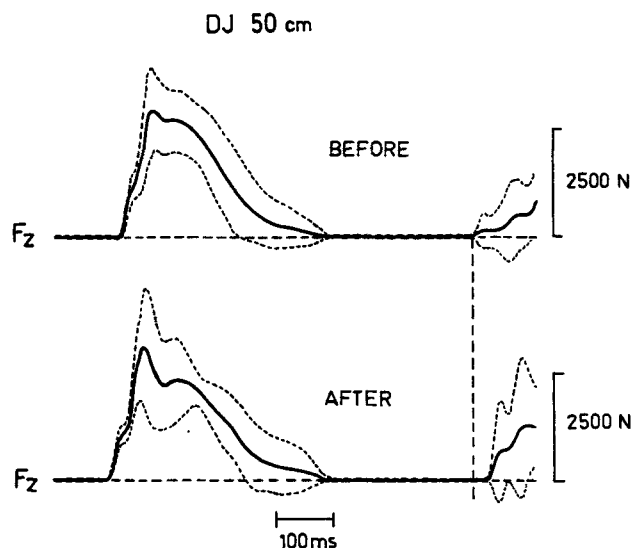

Fig. 10. Group-averaged (mean  $\pm$  SD) Fz curves of the before and after marathon drop-jump test.

worthy, although the impact force peak appeared significantly decreased after marathon (Fig. 10). These observations suggest possible changes in the muscle stiffness characteristics and, therefore, in the amount of storage of elastic energy of the braking phase.

An impairment of good recoil is then expected to occur in the final push-off phase of the SSC. Indications of this can be seen in the sprint recordings, in which the reduced average vertical force of the braking phase (at 20 and 30 km) was followed in the push-off phase by a decrease of the average horizontal force. Concomitantly, both braking and push-off phase durations of the contact times were longer than in the pre-marathon sprint test. In this connection, it would have been of interest to examine how the transfer from the braking to the push-off phase occurred. To be efficient, the transition between these 2 phases needs to be short, since too long a coupling time results in a loss of the stored elastic energy by dissipation as heat (14). It is therefore possible that the repetitive stretch loads of marathon running cause the transition time from stretch to shortening to become longer, with subsequent reduction in storage of elastic energy. The final action would then be reduced potentiation of performance in the SSC cycle. In accordance with this, the observed longer push-off phase in the sprint suggests an unsuccessful attempt to compensate for the lost elastic potential.

Another type of compensatory mechanism of fatigue could be seen in the DJ test. A higher average (NS) impact force peak was observed in the post-marathon DJ record than in the pre-marathon record (Fig. 10). This may have resulted from increased muscle stiffness before contact to compensate for a loss of contractile capacity under stretch. Such a mechanism may happen if more motor units become active during the preparatory phase. The level of the impact force peak has been found to correlate well with the preactivation in the gastrocnemius muscle (15). The function of the preactivation would be to buffer high initial impact load and to trigger an adequate segmental reflex activity to adjust the muscle stiffness. This regulation could be specifically used in DJ since the time before impact is relatively long. As previously discussed, however, high-impact loads become more difficult to tolerate when muscular fatigue progresses. Thus, the deteriorated impact damping induced by the repetitive submaximal stretch loads of the marathon run could not be sufficiently compensated to preserve the pre-marathon performance.

If we assume that the observed deterioration of the tolerance to stretch loads is caused by a lower

capacity to generate forces, this could result partly from a slower turnover of the cross-bridges. Prolonged submaximal exercises are known to induce reduction in the release and uptake of  $Ca^{++}$  by the sarcoplasmic reticulum (SR) (16,17). In this experiment, this hypothesis is supported by the slowing of the rate of force development noticed in the post-marathon maximal isometric strength test.

Another plausible factor for the lost potential would be an altered reflex regulation. As discussed by Gollhofer et al. (18), this could include changes in Ia-afferent sensitivity, in  $\alpha$ - $\gamma$  linkage, or in the Golgi tendon organ inhibition. Referring with caution to observations from animal studies, possible increased Ia and II afferent sensitivity (19,20) as well as an inexcitability of the tendon organ endings (20) may be speculated to occur during long-term exercise. Such mechanisms would provide increased excitation of the alpha motoneurons and favor increased stiffness. This could, however, make the fatigue progress faster, with a subsequent decline in firing frequency and contractile tension (21). This latter phenomenon might support our observations of reduced impact damping (in DJ, sprint and 5J) and of lower average braking force (in 5J and in sprint) after marathon. It could also be assumed that facilitative actions may provide compensation until a certain level of muscular fatigue, after which the regulatory actions become inhibitory. The reduced impact damping may suggest that the sensitivity of the Golgi tendon organ could have increased, providing a greater inhibitory influence to protect the neuromuscular system. During exhaustive SSC repetitions with the arms, Gollhofer et al. (18) observed that SSC fatigue affected EMG responses when especially high stretch loads (falls) were used. They suggested an inhibitory mechanism occurring in overload conditions. In this experiment, similar mechanisms may have occurred in the DJ situation. This test appears suitable to examine the progress of fatigue because the absolute stretch load is fixed, provided that the jumping technique remains the same.

In conclusion, marathon running resulted in an expected reduction of maximal force production in both isometric and dynamic situations. The particular investigation of the ground reaction force changes showed a reduced ability to sustain stretch loads. This suggests that the fatigue occurred primarily in the force generation across the cross-bridges, resulting in an altered muscle stiffness and a reduced efficiency, with a concomitant loss of elastic energy potential. Our observations emphasize, furthermore, the plasticity of the fatigue-compensatory mechanisms. Muscular behavior was seen to be modified depending on the test load and



adjusted during the successive pre-, braking and push-off phases of the ground contact.

### Acknowledgements

The authors wish to acknowledge J. Avela, A. Belli, T. Gelat, M. Ruuskanen, P. Puttonen and M.-L. Romppanen for technical assistance and data analysis.

This research was supported in part by grants 8590/78/88 and 88/722/89 (Komi) from the Ministry of Education, Finland, and by grant 88/8275 (Marconnet) from the Conseil Régional Provence Côte d'Azur, France.

### References

- Viitasalo JT, Komi PV, Jacobs I, Karlsson J. Effects of prolonged cross-country skiing on neuromuscular performance. In: Komi PV, ed. *Exercise and sport biology international series on sport sciences*. Champaign, IL: Human Kinetics Publishers, 1982: 12: 191–198.
- Komi PV, Hyvärinen T, Gollhofer A, Mero A. Man-shoe surface interaction: special problems during marathon running. *Acta Univ Oul [A]* 1986; 179: 69–72.
- Gollhofer A, Komi PV, Miyashita M, Aura O. Fatigue during stretch-shortening cycle exercise: changes in mechanical performance of human skeletal muscle. *Int J Sports Med* 1987; 8: 71–78.
- Komi PV, Bosco C. Utilisation of stored elastic energy in leg extensor muscles by men and women. *Med Sci Sports* 1978; 10(4): 261–265.
- Viitasalo JT, Komi PV. Interrelationships of EMG signal characteristics at different levels of muscle tension and during fatigue. *Electromyogr Clin Neurophysiol* 1978; 18: 167–178.
- Komi PV, Tesch P. EMG frequency spectrum, muscle structure and fatigue during dynamic contractions in man. *Eur J Appl Physiol* 1979; 42: 41–52.
- Komi PV, Viitasalo JT. Changes in motor unit activity and metabolism in human skeletal muscle during and after repeated eccentric and concentric contractions. *Acta Physiol Scand* 1977; 100: 246–254.
- Sherman WM, Armstrong LE, Murray TM et al. Effect of a 42.2-km footrace and subsequent rest or exercise on muscular strength and work capacity. *J Appl Physiol* 1984; 57(6): 1668–1673.
- Asmussen E, Mazin B. Recuperation after muscular fatigue by “diverting activities”. *Eur J Appl Physiol* 1978; 38: 1–7.
- Asmussen E, Mazin B. Central nervous component in local muscular fatigue. *Eur J Appl Physiol* 1978; 38: 9–15.
- Bigland-Ritchie B, Jones DA, Hosking GP, Edwards RHT. Central and peripheral fatigue in sustained maximal voluntary contraction of human quadriceps muscle. *Clin Sci Molec Med* 1978; 54: 609–614.
- Dietz V, Schmidtbleicher D, Noth J. Neuronal mechanisms of human locomotion. *J Neurophysiol* 1979; 12(5): 1212–1223.
- Komi PV. Biomechanical features of running with special emphasis on load characteristics and mechanical efficiency. In: Nigg BM, Kerr BA, ed. *Biomechanical aspects of sportshoes and playing surfaces*. Calgary: University of Calgary, 1983: 123–134.
- Cavagna GA, Dusman B, Margaria R. Positive work done by a previously stretched muscle. *J Appl Physiol* 1968; 24: 21–32.
- Komi PV, Gollhofer A, Schmidtbleicher D, Frick U. Interaction between man and shoe in running: considerations for a more comprehensive measurement approach. *Int J Sport Med* 1987; 8: 196–202.
- Vergara J, Bezanilla F, Salzberg BM. Nile blue fluorescence signals from cut single muscle fibers under voltage or current clamp conditions. *J Gen Physiol* 1978; 72: 775–800.
- Fitts RH, Courtright JB, Kim DH, Wiltman FA. Muscle fatigue with prolonged exercise: contractile and biochemical alterations. *Am J Physiol* 1982; 242: C65–C73.
- Gollhofer A, Komi PV, Fujitsuka N, Miyashita M. Fatigue during stretch-shortening cycle exercises. II. Changes in neuromuscular activation patterns of human skeletal muscle. *Int J Sports Med* 1987; 8 (suppl 1): 38–47.
- Nelson DL, Hutton RS. Dynamic and static stretch responses in muscle spindle receptors in fatigued muscle. *Med Sci Sports Exerc* 1985; 17 (4): 445–450.
- Kidd GL, Kucera J, Vaillant CH. The influence of the interstitial concentration of K<sup>+</sup> on the activity of muscles receptors. *Physiol Bohemoslov* 1971; 20: 95–108.
- Hutton RS, Nelson DL. Stretch sensitivity of Golgi tendon organs in fatigued gastrocnemius muscle. *Med Sci Sports Exerc* 1986; 18 (1): 69–74.