



HAL
open science

A neural network model for the intersensory coordination involved in goal-directed movements

Y. Coiton, J. C Gilhodes, Jean-Luc Velay, J. P Roll

► **To cite this version:**

Y. Coiton, J. C Gilhodes, Jean-Luc Velay, J. P Roll. A neural network model for the intersensory coordination involved in goal-directed movements. *Biological Cybernetics (Modeling)*, 1991, 66 (2), pp.167 - 176. 10.1007/BF00243292 . hal-01706488

HAL Id: hal-01706488

<https://amu.hal.science/hal-01706488v1>

Submitted on 10 Apr 2018

HAL is a multi-disciplinary open access archive for the deposit and dissemination of scientific research documents, whether they are published or not. The documents may come from teaching and research institutions in France or abroad, or from public or private research centers.

L'archive ouverte pluridisciplinaire **HAL**, est destinée au dépôt et à la diffusion de documents scientifiques de niveau recherche, publiés ou non, émanant des établissements d'enseignement et de recherche français ou étrangers, des laboratoires publics ou privés.

A neural network model for the intersensory coordination involved in goal-directed movements

Y. Coiton, J. C. Gilhodes, J. L. Velay, and J. P. Roll

Laboratoire de Neurobiologie Humaine, Université de Provence, Faculté de St Jérôme, C.N.R.S. U.R.A. 372, Avenue Escadrille Normandie-Niemen, F-13397 Marseille CEDEX 13, France

Abstract. A neural network model for a sensorimotor system, which was developed to simulate oriented movements in man, is presented. It is composed of a formal neural network comprising two layers: a sensory layer receiving and processing sensory inputs, and a motor layer driving a simulated arm. The sensory layer is an extension of the topological network previously proposed by Kohonen (1984). Two kinds of sensory modality, proprioceptive and exteroceptive, are used to define the arm position. Each sensory cell receives proprioceptive inputs provided by each arm-joint together with the exteroceptive inputs. This sensory layer is therefore a kind of associative layer which integrates two separate sensory signals relating to movement coding. It is connected to the motor layer by means of adaptive synapses which provide a physical link between a motor activity and its sensory consequences. After a learning period, the spatial map which emerges in the sensory layer clearly depends on the sensory inputs and an associative map of both the arm and the extra-personal space is built up if proprioceptive and exteroceptive signals are processed together. The sensorimotor transformations occurring in the junctions linking the sensory and motor layers are organized in such a manner that the simulated arm becomes able to reach towards and track a target in extra-personal space. Proprioception serves to determine the final arm posture adopted and to correct the ongoing movement in cases where changes in the target location occur. With a view to developing a sensorimotor control system with more realistic salient features, a robotic model was coupled with the formal neural network. This robotic implementation of our model shows the capacity of formal neural networks to control the displacement of mechanical devices.

Introduction

This paper deals with the modelling of sensorimotor representation together with motor control. The as-

sumption is made that aiming movements somehow require the use of an internal space representation system to which all activities are referred, and that the processes involved in the motor and perceptual aspects of behaviour have to be considered jointly. It is assumed moreover that this internal model for the sensory environment is built up through its own system's activity, by an autonomous, self-organized process.

Visuo-manual reaching is one of the most basic spatially oriented activities carried out by humans, and involves complex sensorimotor and intersensory coordination (Paillard 1971; Georgopoulos 1986). In particular, reaching an object requires that a sensorimotor linkage be established, associating the position of the object with the motor command guiding the hand towards it. As far as the sensory aspects are concerned, it should first be pointed out that the nervous signals carrying sensory information to the central structures are numerous. They have been classified into various sensory modalities, depending on the receptors from which they originate and on specific factors acting on these receptors. For the purposes of the present study, it seemed to suffice, to make a broad distinction between *proprioception*, which specifies the relative positions of the body segments, and *exteroception* (mainly vision), which provides information about events occurring in extra-personal space. In a first approximation, proprioceptors can be taken to be sensors giving angular values of the various joint positions; these values can be regarded as intrinsic coordinates, since they specify only positions of body segments in the body-space frame of reference; whereas exteroceptive information may be processed in terms of extrinsic coordinates with respect to extra personal space.

Proprioception and vision are not necessarily simultaneously required in arm-reaching, however. There may exist situations where the target position is not defined visually but is coded directly in body space or in intrinsic coordinates, as for instance when reproducing an arm posture or trying to superimpose the fingertips of the two hands (Paillard and Brouchon 1974; Velay et al. 1989). In such cases, proprioception should theoretic-

cally suffice to be able to perform aiming movements. Vision alone can also supply the relative target and hand positions in extra-personal space, and hence goal directed movements might be possible without any need for proprioception. Nevertheless, movements directed towards external objects are generally organized on the basis of several sensory signals. The body segment positions are primarily given by proprioceptive inputs and it has been known for a long time that aiming movements are still possible in the absence of any visual guidance of the hands (Woodworth 1899). In this so-called "visual open loop" situation, subjects' pointing performances are less accurate than under visual control, but they are still quite satisfactory (Prablanc et al. 1979; Velay and Beaubaton 1986). This means that the sensorimotor system is able to guide the proprioceptively located hand towards a visually defined target; in other words, it has to not only perform a sensorimotor transformation but also build up intersensory relationships in order to link a visually determined position with a proprioceptively specified arm configuration.

The aim of this study was to attempt to model the processes underlying an example of sensorimotor behaviour which is performed on a multisensory and motor basis. Over recent years, several neuromimetic models for neural networks have dealt with sensorimotor behaviour on similar lines. A common property of these models is that the sensorimotor coordination arises from a learning phase and is not given a priori. Learning is performed through active motor behaviour, involving changes in the strength of connections; rather different algorithms, based on either supervised or unsupervised procedures, have been used in the simulations. In the case of supervised learning, the algorithm of back propagation (Rumelhart et al. 1986) has often been applied (Jordan 1989; Massone and Bizzi 1989; Dean 1990). Most of the models for unsupervised learning have been based on mapping (Coiton 1987; Kuperstein 1988; Ritter et al. 1989; Gilhodes et al. 1991). Maps of this kind can be said to result from a self organizing process rather than being genetically inherited, and some sensorimotor models have included a self-organized mapping, using Kohonen's algorithm in particular (Coiton 1987; Ritter et al. 1989; Gilhodes et al. 1991).

For this purpose we developed a neural network model driving an artificial arm (see Figs. 1 and 6). This network is composed of formal neurons or cells organized in two distinct layers, the one devoted to the sensory information processing, and the other to the motor command, the link from the former to the latter being the sensorimotor coordination. The sensory layer organization is based on Kohonen's self organizing map (Kohonen 1982). One of the main advantages of Kohonen's model is its ability to build a representation of sensory space on the basis of afferent information. Representations or maps of this kind are known to exist in the central nervous system of superior vertebrates; they are embedded in various brain structures, particularly the cortex, and they are often organized in such a way that the topology is preserved. From this point of

view Kohonen's model satisfies the neurobiological plausibility criterion. The possibility of building space representation through unsupervised learning was vital to our purpose, which was to develop a model of sensorimotor organization in which the emergence of maps is induced by self motor activity. Active movement has been shown by Held and Hein (1963) to play an important role in the elaboration of sensory motor coordination.

The motor layer of the network is composed of cells, one cell for each motor moving an arm joint. The sensory motor coordination lies in junctions linking sensory to motor cells. By using a delta rule (Widrow and Hoff 1960), in which the desired output is replaced by the actual output, to govern the development of synapse efficiency, it is possible to build up a motor map simultaneously with the sensory map described above.

The model thus constituted enables us to approach questions relating to the general problem of sensorimotor coordination. More specifically, the questions addressed in the present study were as follows: 1) How can multisensory association be organized in a central spatial map? 2) How can aiming movements be performed on the basis of this type of representation?

In an early stage, numerical simulations of the model were drawn up to study its main properties, and this computational network model was then connected to a real robot arm in order to test whether it could drive the arm and how robust it was when exposed to physical constraints.

Model description

The model consists of a set of motor and sensory elements, including both effectors and sensors, connected to a neural network (Fig. 1).

The neural network drives a simulated arm by sending orders to effectors, and in turn receives signals about the current position from the various sensors. The sensory signals are of two kinds, depending upon the type of sensor. The signals of the first kind are emitted by sensors linked to the motor system which provide information about the relative positions of the diverse arm-segments. These signals, which are coded in terms of angular values, simulate proprioceptive information. The signals of the second kind are supplied by sensors placed in the working space, which is not linked to the arm. The latter signals feed the sensory layer with the position of the arm-tip in physical space, thus simulating the work of an exteroceptive sensory modality, such as vision.

The neural network consists of two separate layers:

- The sensory or associative layer is composed of a set of formal neurons (or cells) arranged in a matrix. Recurrent collaterals link these cells in an excitatory manner in the case of neighbouring cells and in an inhibitory manner in that of remote cells. This organization was based on the cortical architecture. The prop-

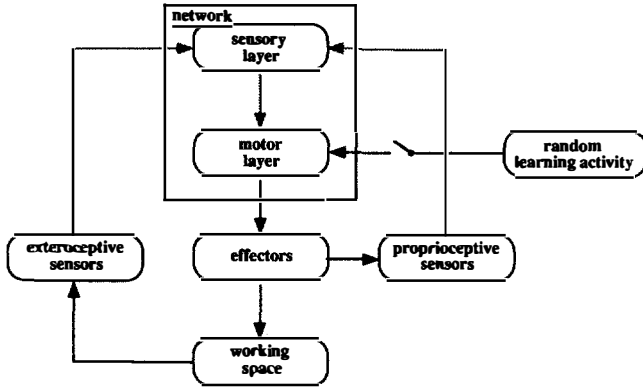

Fig. 1. Diagram of the Neurobot model. Adaptive junctions which are responsible for the plasticity are shown by grey arrows. The randomly generated activity occurs only during the learning phase

erties of this sensory layer have been described by Kohonen (1982), who showed that by means of a self-organizing process this structure is able to produce a topological map where neighbouring events occurring in the working space give rise to neighbouring activities in the sensory layer. One of the particularities of our model is due to the fact that two kinds of afferent signal are involved. Each sensory cell is thus connected to sensory receptors by means of adaptive synapses.

– The motor layer comprises a set of cells, each of which specifically controls a motor effector. The connection between the two layers, that is the sensorimotor linkage, was provided by making all the sensory cells converge onto each motor cell. These junctions are adaptive.

Before learning, the synaptic efficiencies are randomly defined, so that no topological relationships exist between the position of the arm in space and the cell activities in the sensory layer. At the end of this period, the topological relationships are preserved because sensory patterns corresponding to neighbouring points in space, or neighbouring arm configurations, are represented by anatomically neighbouring cells in the sensory layer.

The successive steps involved in the self-organization process can be summarized schematically as follows: initially, all the synaptic weights are randomly defined. The learning period consists of a series of randomly chosen motor activities, leading to arm positions which are uniformly distributed across the working space. Each positioning cycle is composed of the following steps. First, the random activity of motor cells determines the position of the arm and secondly, the resulting afferent information produced by the two types of sensors is distributed to all the sensory layer cells. An activity focus (cluster) is then formed, and the synaptic coefficient of the cells belonging to this cluster are updated depending on the afferent input activity. Synaptic changes occur in both afferent and sensorimotor junctions; they tend to enhance the correlations between the synaptic coefficient and the afferent information in the former case, and between the synaptic

coefficient and the motor activity in the latter. Thus, at the level of the sensory synapses, a representation mixing exteroceptive and proprioceptive information, i.e. a map associating the working space with the arm configuration space, gradually emerges, whereas at the sensorimotor synapse level, a representation of the arm motor commands is built up. Both plasticity laws involve a sensitivity factor, or adaptation gain, that progressively decreases during the learning period, and becomes null at the end.

Evolutionary algorithm of the sensory layer

During the learning phase, the continuous projection of sensory patterns composed of combined proprioceptive and exteroceptive signals onto the sensory cells gives rise to a topology-preserving mapping of both external and arm-space in this layer. The sensory patterns can be mathematically represented by vectors x with the same dimension as the number of sensors in a given sensory space $X(x \in X)$. A vector $\mu_i \in X$ is allotted to each cell i ; it corresponds to the synaptic weights of all the sensory projections onto the cell i . At each position reached, we take the sensory neuron c such that:

$$\|\mu_c - x\| = \min_i \|\mu_i - x\|. \quad (1)$$

This cell c is located in the centre of the cluster of activity generated by the vector x . Equation (1) was proposed by Kohonen (1984); it leads to a simplified algorithmic procedure for determining, in terms of Euclidian distance, the cell c showing the best match between μ_i and x . At the sensory layer level, the most specific characteristics of our model as compared with that by Kohonen concerns the input vector x which consists here of sensory signals (ξ) of two kinds; the first arise from the n proprioceptive sensors ($p_1 \dots p_n$) and the second form m exteroceptive sensors ($e_1 \dots e_m$). The sensory vector is therefore $x = (\xi p_1, \xi p_2, \dots, \xi p_n, \xi e_1, \xi e_2, \dots, \xi e_m)^T$. At time t , the weight adaptation law for the synapses corresponding to the vector μ_i allotted to a cell i is given by:

$$\mu_i(t) = \mu_i(t-1) + \alpha(t) \cdot \omega_{ic}(t) \cdot (x - \mu_i(t-1)). \quad (2)$$

Equation (2) is a ‘‘Hebb-like’’ adaptation law, because the post-synaptic cell is active (output at ‘‘1’’) when it is performed; it was proposed by Kohonen (1984) for building a topology conserving map of sensory signals. In this, $\alpha > 0$ denotes an adaptation coefficient in terms of time, and ω_{ic} is an adaptation coefficient depending on the time and distance $d(i, c)$ between cells i and c . ω_{ic} must be maximal when $d(i, c) = 0$. The decremental function of ω_{ic} might be simply a linear function, but a Gaussian function greatly increases the convergence speed. ω_{ic} was therefore taken to be:

$$\omega_{ic}(t) = \exp(-\|i - c\|^2 / 2\sigma(t)^2). \quad (3)$$

During the learning period, the adaptation coefficient α and the parameter σ of ω_{ic} gradually decreases:

$$\alpha(t) = \alpha_{ini} \cdot (\alpha_{fin} / \alpha_{ini})^{t/t_{max}} \quad (4)$$

$$\sigma(t) = \sigma_{ini} \cdot (\sigma_{fin} / \sigma_{ini})^{t/t_{max}} \quad (5)$$

where t_{\max} is the maximum number of iterations and $\alpha_{\text{ini}}, \sigma_{\text{ini}}, \alpha_{\text{fin}}, \sigma_{\text{fin}}$ denote the initial and final values of these parameters.

Equations (3), (4) and (5), proposed by Ritter et al. (1989), tend to make the mapping faster because salient map features are first rapidly built, and the refinements occur at the end of learning.

The analogous sensory patterns are spatially coded in the sensory layer. In fact, the position of any cluster which depends on the input values, so that the bell-shaped profile of the output pattern is constant whatever the input, and the output of each sensory cell will be strictly linked to its position relative to the centre of the cluster (cell c). The sensory cell c itself exhibits a saturated output which is taken to be equal to 1.

Evolutionary algorithm of the motor layer

Since the characteristics of the inputs to the sensory and motor layers were quite different, a different adaptation law from that previously described was used at the level of the junction between the sensory and the motor cells. The synaptic plasticity on the motor layer was ensured by the linear error correction rule proposed by Widrow and Hoff (1960), but since the network is not supervised, the “desired” output was replaced by the “actual” motor output. During the learning period, the output of the motor cells was arbitrarily imposed in order to produce random movements. The correction rule tends to pull the synaptic weights toward the imposed post-synaptic activity level of the motor neurons responsible for the position reached, and hence for the emergence of the cluster on the sensory layer. Sensori-motor junctions evolve in such a way that they conserve the relationship established between a given motor action and its sensory consequences. The motor outputs can be represented by vectors y , having as many dimensions as there are effectors, in a motor space $Y (y \in Y)$. A vector $\mu'_i \in Y$ is associated with each sensory cell i . It corresponds to all the synaptic weights of its projection onto all the motor cells. The output vector of the motor layer, i.e. one of the possible configurations of the arm, is $y = (s_1, s_2, \dots, s_q)^T$. It is sent to the q effectors and its adaptation law at time t is given by:

$$\mu'_i(t) = \mu'_i(t-1) + \alpha(t) \cdot \omega_{ic}(t) \cdot (y - \mu'_i(t-1)). \quad (6)$$

The coefficients α and ω_{ic} are defined above and the rules concerning their variations over time are described by (3), (4) and (5). The values of the various parameters generally depend on the size of the network: for instance, with a 400-cell network, $t_{\max}, \alpha_{\text{ini}}, \sigma_{\text{ini}}, \alpha_{\text{fin}}$ and σ_{fin} were taken to be equal to 2000; 0.25; 5; 0.25×10^{-3} and 0.2, respectively. The sensory layer outputs are the inputs to the motor layer; consequently, the synapses between the above sensory cell c and the motor cells have the most greatly modified weights and the synapses between the other sensory cells and the motor cells are modified in proportion to their activity, i.e. depending on the distance from the given sensory cell to cell c . At the motor level, the synaptic changes therefore

obey the α and ω functions. Once learning has been completed, a second phase or “exploitation phase” begins. At this moment, ω is totally “centred” on the sensory cell c which becomes the only active cell of the sensory layer, all the others being inactive. Under these conditions, the sensory layer works like an analog to digital converter, because the afferent activities are still of analog nature, whereas the post-synaptic activity is now digital, i.e. cell c shows a saturated output set at 1. Conversely, the motor layer works like a digital to analog converter because the digital pre-synaptic activity induces a post-synaptic motor activity which is modulated by the diverse synaptic weights and is consequently multivalued and analog. It should be noted that the motor activities which were randomly imposed during the learning phase were subsequently induced by the sensory layer, the random motor activity generator having been disconnected. When learning is complete, the arm is able to perform reaching movements.

Simulations

With a view to answering the questions mentioned above, we carried out several simulations, in order to test the main properties of the model. For the sake of clarity, the results obtained with simplified forms of the model involving numerical simulations will be described first. Simulations performed with the real robot arm will be presented subsequently.

Numerical simulations

The network was connected to a simulated two-jointed arm, the proximal extremity of which was fixed, while the distal one was able to move in a plane. Proprioceptive messages were coded in terms of the angular value of each joint and the exteroceptive messages were coded in terms of the Cartesian coordinates of the arm tip in the plane. Motor commands were given in the form of an angular position for each joint. With this simplified simulation, it is possible to illustrate several properties of the model:

- The space representation in the sensory layer depends on whether proprioceptive or exteroceptive afferent signals are used.
- A representation also emerges in the sensory layer when it is fed with two different sensory signals, thus giving rise to an associative map.
- A sensorimotor coordination is established in the junctions linking the sensory and motor layers.
- After the learning period, the arm is able to reach and track a target located by means of the exteroceptive sensory modality.
- The initial arm configuration influences all the positions through which the arm moves before reaching the target.

Space representation in the sensory layer. One of the main properties of the model is its ability to induce a space representation at the sensory layer level,

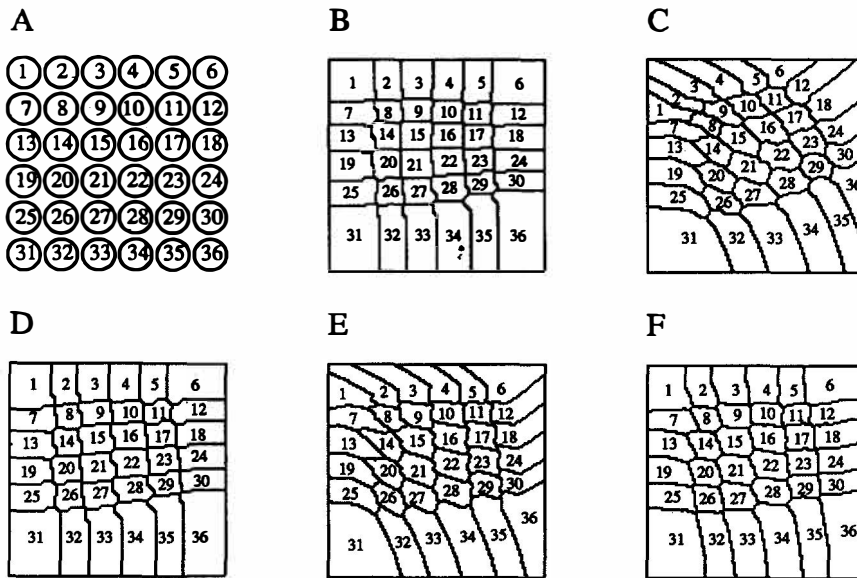

Fig. 2A–F. After learning, various topological maps can be obtained depending on the type of afferent sensory signal used. (A) shows the 36 sensory cells arranged in a 6×6 matrix. (B–F) show the sensory fields of the sensory layer cells. Each part of the working space is indexed according to the number of the cell involved. Note that although in all cases a topology emerged in the sensory layer, the shapes, dimensions and positions of the fields varied depending on the type of afferent information: Cartesian (B), angular (C) or both Cartesian and angular (F). In the latter situation it is possible to dissociate the respective contributions of Cartesian (D) and angular (E) inputs to the bi-sensory spatial representation

combining exteroceptive and proprioceptive information. To illustrate this property, various maps resulting from active exploration of a two dimensional space by a two-jointed arm are shown in Fig. 2. Here the work space is divided up into receptive fields. A cell's receptive field is the part of the space the exploration of which triggers the cell activity. As shown in Fig. 2, the mapping of the working space depends on the nature of the afferent information used to feed the sensory layer. The position of the arm is therefore given either in terms of the Cartesian coordinates of the arm tip (Fig. 2B) or in terms of angular values, one value for each joint (Fig. 2C). In the third case, the network has been supplied with both Cartesian and angular inputs (Fig. 2F). In all three cases, learning led to topological maps in which the receptive fields were organized differently. It can be seen that mixing two types of afferent signals gave rise to an associative map combining both Cartesian (Fig. 2D) and angular (Fig. 2E) features.

Sensorimotor links. Closely related to the emergence of a topological map at the sensory level, a motor command representation also emerged depending on the synaptic efficiency of the junctions linking sensory and motor cells. These junctions are modified during the learning period in such a way that they memorize the sensorimotor links, that is the relationships between a motor command and its sensory consequences. Figure 3 illustrates the motor command representation by means of synaptic efficacy gradients shown before (step 0, on the left) and after learning (step 1000, on the right).

Directed movements. When the learning period has been completed, the arm, whatever its initial position, is able to perform a goal-directed movement towards a target located anywhere in the space previously explored. As pointed out above, one advantage of the associative capacity of the sensory layer is that it is compatible with the multisensory coordination of the

motor control. The exteroceptive modality providing information about the arm tip position is therefore now used to locate the target, and the proprioception contributes towards coding the current arm configuration. It should be stressed here that during the learning period, both modalities were always correlated, each giving a specific type of information about the arm position. During the pointing task, exteroceptive inputs specifying the target position and proprioceptive inputs describing the arm configuration would give rise to separate clusters on the sensory layer if they were taken separately. When processed together, however, they generate a single cluster situated midway between the two virtual ones. As a matter of fact, the activity focuses on the cell in which the synaptic weights are the

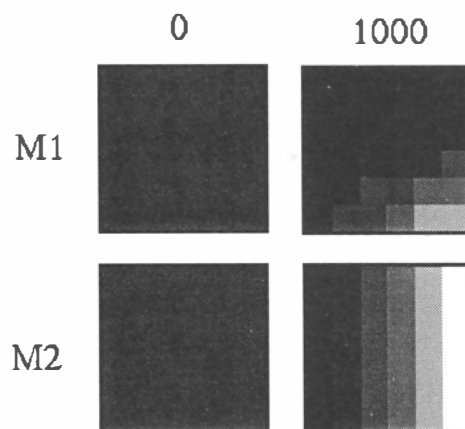

Fig. 3. Diagram of the sensorimotor connections in the case of a network driving a two-jointed arm. The maps denote the state of the synaptic weights of the 36 junctions between the sensory cells and each motor cell ($M1$ and $M2$). Sensory cells are arranged in the same manner as shown in Fig. 2a. Synaptic coefficient values are indicated by a grey scale in a linear range from white (minimum) to black (maximum). The sensorimotor linkage is shown before (step 0, on the left) and after (step 1000, on the right) the learning period

most closely correlated with both the proprioceptive and exteroceptive inputs and, since the sensory layer forms a topological map of the sensory inputs, the resulting cluster is located between the two virtual clusters. This intermediate activity focus triggers, via the motor cells, a displacement of the arm. The proprioceptive signals are then modified, leading to a new intermediate activity focus, and so on. Each step can thus be summarized as follows:

1. The afferent sensory pattern, composed of exteroceptive and proprioceptive inputs, triggers an activity focus in the sensory layer (according to (1)).

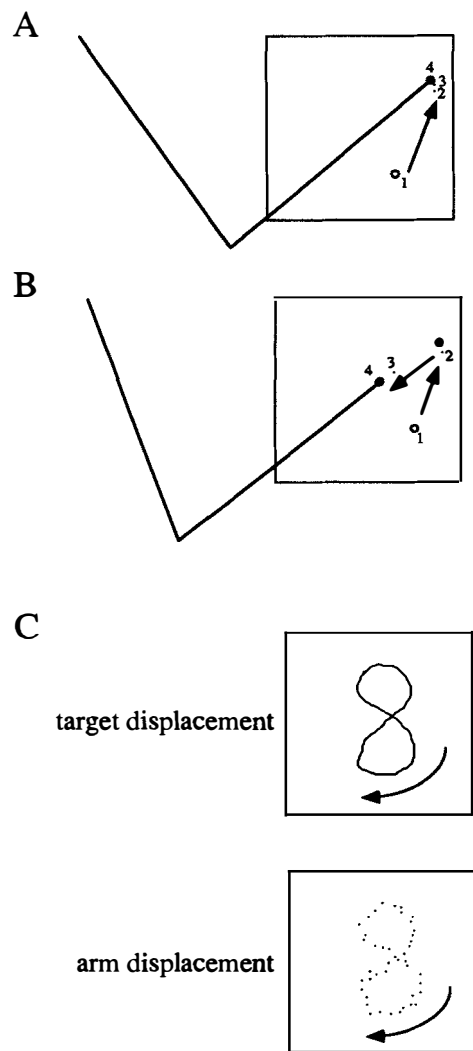

Fig. 4A–C. Examples of pointing movements performed by a simulated two-jointed arm moving in a plane. The sensory layer was composed of 400 cells and 1000 positions were performed during the learning period. **A** The filled circles denote the target and the four points (numbered from 1 to 4) indicate the successive positions of the arm tip. Note that the movement is divided into steps with a decreasing amplitude. **B** Double target experiment. The first target (grey circle) was turned off after the arm began to move and was replaced by the second target (filled circle). The arm trajectory was then directed towards the second target. **C** If the target was continuously displaced, the arm was able to pursue it along the whole trajectory

2. The sensory cell situated at the centre of the focus triggers a displacement of the arm tip towards a new position given by the coefficient of sensorimotor junction linking this cell to each motor cell.

3. Once a new position has been reached, the proprioceptive signals change.

This cycle is repeated until the arm tip has reached the target, when the exteroceptive and proprioceptive information are again correlated (Fig. 4A and B). As can be seen from Fig. 4C, if the target is continuously displaced, the arm performs a pursuit movement.

Role of the initial posture. We investigated the influence of the initial postural configuration of the arm on its final position when the target is reached. For this purpose, simulated arm movements were performed with the proximal joint (“shoulder”) centred in a plane working space. Each arm joint was able to move freely by rotating 360° around its axis. This device gives rise to some ambiguity, since two separate configurations of the arm are possible for one and the same arm tip location. During the learning period, the network indiscriminately associates one exteroceptive input with either one or other of the two possible proprioceptive inputs. Figure 5 illustrates the behaviour of a model of this kind during pointing tasks performed after learning. In both cases shown, the initial and final arm tip locations were similar but different initial arm configurations were chosen. One can observe that the initial arm posture was maintained throughout the trajectory and that this posture determined the final configuration adopted.

Robotic simulation

A robotic model was developed with a view to approaching more realistic salient features of sensorimotor control. In these studies, neural networks were simulated by a microcomputer linked to an actual robotic arm (Cyber Robotics 310). The sensory layer was composed of 400 cells and the motor one of 3 cells. The robotic arm moved in a 3D space using 3 motorized joints able to rotate around their axis. The angular positions of the joints were given by 3 linear potentiometers fixed to each motor axis, producing analog proprioceptive signals. The exteroceptive sensors consisted of 3 Electrical Photo Cells (EPC) fixed independently of the arm, and in such a manner that each one

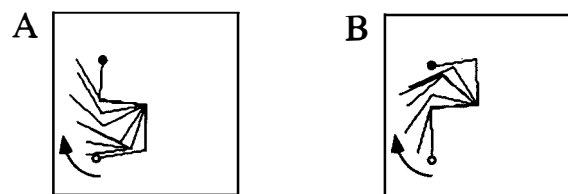

Fig. 5A, B. This figure shows the influence of the initial arm posture. The same initial position of the arm-tip (empty circle) can correspond to two arm configurations (**A** and **B**). During its displacement, the arm maintains a posture closely related to the initial one

was orthogonal to the others. They were placed outside the limits of the working space. A light fixed to the arm tip stimulated the EPC, inducing a set of 3 "visual" inputs characterizing the arm tip position. The visual signals sent onto the sensory layer were not linear, since the EPC furnished an output tension V which depended on their distance d from the light source according to a power function. In addition, since the distance d was constant, V varied with the luminous ray angle of incidence according to a third degree polynomial function. Moreover, when the distance and angle of incidence were kept constant, the cell's output tension V exhibited fluctuations of about 2%, that is, the exteroceptive inputs were noisy. Voltages provided by the potentiometers and the EPC fed the sensory layer via an analog to digital converter. In turn, the simulated motor cells produced motor commands leading to various robot positions (Fig. 6).

The learning period was identical to that previously described in the case of the numerical simulations. Examples of maps obtained before (Fig. 7A) and after (Fig. 7B, C) the learning are given in Fig. 7 in the form of synaptic efficiency gradients. These maps, which were elaborated by means of linear and non linear sensors describing a 3D space, give rise to several remarks:

1) Representing a 3D space with a 2D neural network is only feasible at the cost of one dimension. This is particularly clear in the case of linear sensors, where the resulting gradients are almost continuous with two dimensions (Fig. 7B5-B6) and not with the third one (Fig. 7B4), which is more ambiguously represented. It is known that with this algorithm, the network self-organization is accomplished to the detriment of the dimension having the inputs with the smallest variance (Kohonen 1984). An elegant way of overcoming this

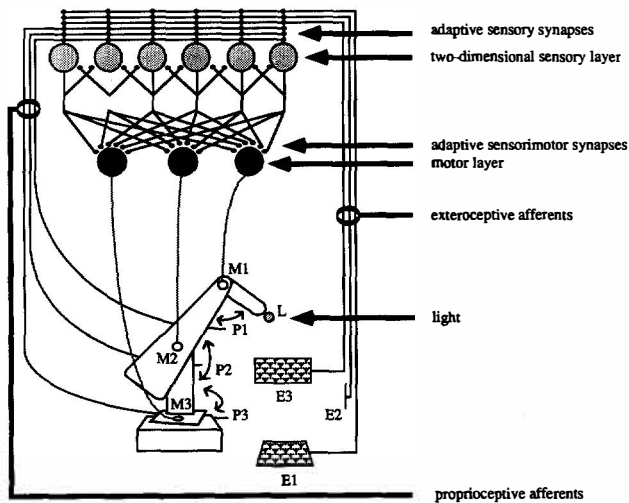

Fig. 6. Schematic diagrams of the robotic simulation. The network is linked to a three-jointed artificial arm. Each of the motor cells is connected to one of the three motors ($M1$, $M2$, $M3$). Thanks to a light (L) carried by the arm tip, photo-cells ($E1$, $E2$, $E3$) supply the sensory layer with the arm-tip position in working space. Three goniometers ($P1$, $P2$, $P3$) fixed to the three joint axes inform the sensory layer about the arm configuration

limitation might be to build a 3D network (Martinetz et al. 1990). It is doubtful however whether this neural architecture would be biologically plausible.

2) The sensors' non linearity is mirrored in the spatial representation. This can be seen clearly from the two correctly mapped dimensions, where the gradients are quasi regular in the case of linear sensors (Fig. 7B5-B6), whereas they vary in a complex manner depending on the transfer function of the sensors when the latter are not linear (Fig. 7B2-B3).

The same comments apply to the motor layer synaptic weights (Fig. 7C). The close similarity between motor and part of the sensory synaptic gradients is due to the common nature of the signals emitted by the potentiometers (angular) and the commands sent to the motors (rotations).

Once the learning period had been completed, the light, which was previously fixed to the arm tip, was removed and used as a target by the experimenter who moved it about in the working space. At this stage, the current position of the arm was given by the poten-

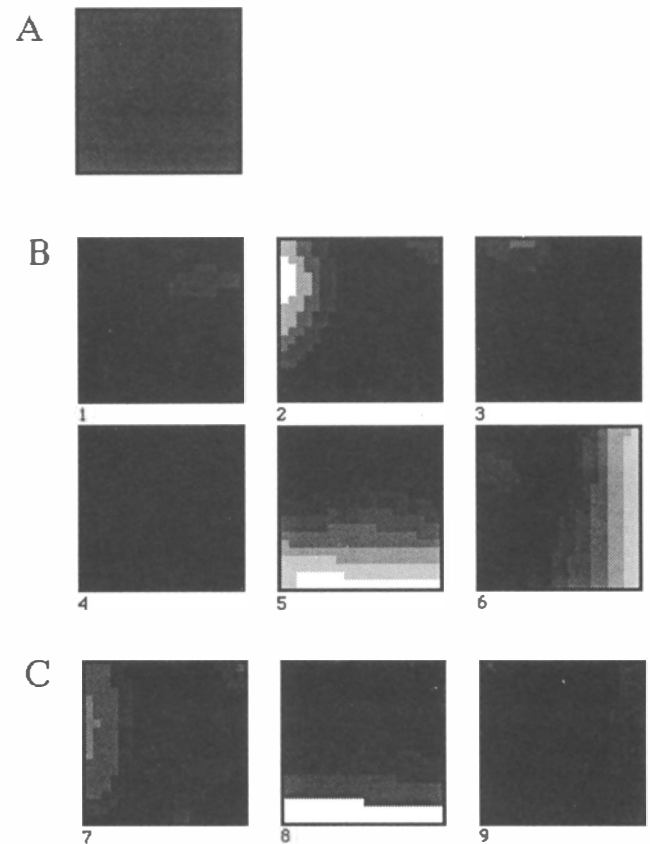

Fig. 7A-C. Robotic simulation. **A** shows the initial state of the sensory layer when all the junctions were undifferentiated. **B** Diagrams showing the synaptic weights of the 3 exteroceptive inputs (**B1-B3**) and the 3 proprioceptive inputs (**B4-B6**) onto the sensory layer after the training period involving 1000 successive randomly chosen positions. **C** Diagrams showing the weights of the sensory junctions to each motor cell (**C1-C3**). Sensory cells are arranged in the same manner as shown in Fig. 2A. The gradients indicate the level of structuring of the layers: synaptic coefficient values are indicated by a grey scale in a linear range from white (minimum) to black (maximum)

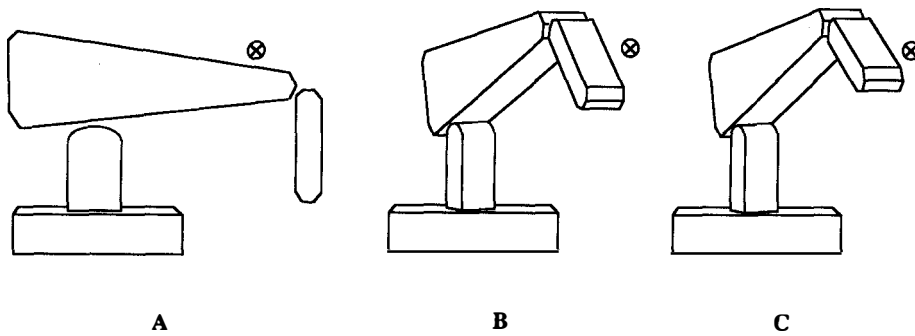

Fig. 8A-C. Successive robot postures during a movement directed towards a visual target (\otimes). In this example, the movement was performed with only one intermediate position (**B**) corresponding to rotations of +71 deg on $M3$, +14 deg on $M2$, and +33 deg on $M1$ with respect to the initial position (**A**). The final position (**C**) was then reached with rotations of +3, +1, and +11 deg on $M3$, $M2$, $M1$, respectively

tiometers and the target position coded by the EPC. The network drove the arm in the vicinity of the light (Fig. 8). Due to the discrete nature of the space representation in the receptive fields at the level of the sensory layer, the robot's aiming accuracy was directly dependent on the number of units in the network. This robotic implementation of our model therefore shows the ability of formal neural networks to control the displacement of physical devices. At this point we would stress that this performance was achieved with noisy signals, and with EPC characterized by a highly nonlinear transfer function.

Discussion

As previously demonstrated by Kohonen (1984), in neural network models of the type described here, a spatial representation progressively emerges in the sensory layer through a self-organizing process, in such a way that the activity of each cell is related to a specific zone within the space, namely its receptive field. This internal model of the environment varies with the nature of the sensory signals sent to the cells, but in all cases the distribution of the receptive fields onto the layer preserves the neighbouring relationships, that is the topology of the space explored. On the other hand, simulations showed that, when fed during the learning period by redundant information coming from diverse sensory modalities, this network was also able to develop a multisensory space representation. The fact that sensory signals of both types (proprioceptive and exteroceptive) converge onto the same cells makes it possible to build up a unified spatial representation integrating both extra-personal and body space information.

Concerning the arm posture representation, we decided to make the proprioceptive signals arising in the 3 joints project onto common sensory cells. In order to obtain a multi-joint representation, we might have conceivably divided the sensory layer into 3 zones, each dealing with one given joint, in order to obtain single-joint neurons. Single-joint neurons are to be found for instance in the somato-sensory cortex of monkeys (Gardner and Costanzo 1981), but multiple-joint neurons are known to exist in both the somato-sensory (Costanzo and Gardner 1981) and parietal associative cortices (Mountcastle et al. 1975; Lynch 1980). The precise role played by each type of neurons is not

known but multiple-joint neurons may extract postural information from several different populations of single-joint neurons. They may therefore act as feature-detectors, extracting information about specific body postures. In the present model, the existence of these multi-joint cells was a necessary condition for obtaining an unambiguous association between a visually defined position and an arm posture.

The setting-up of the sensory map is accompanied by the simultaneous emergence of a sensori-motor organization embedded in the weights of the adaptive junctions connecting the sensory and motor cells; the target position in extra-personal space is transformed into the motor activity corresponding to the correct posture of the arm, which can be regarded as the equilibrium point of the motor system (Feldman 1986).

One point worth mentioning is the crucial role played by active movements during learning in establishing the motor organization. Indeed if, for instance, learning were carried out with passive arm displacements, the sensory layer would still be structured exactly as described above because the same sensory inputs would be sent to the layer. The sensorimotor links, that is the relationships between sensory and motor layers, would not be properly organized, however, since no motor activity would be associated with the sensory pattern. Consequently, despite the correct sensory representation and the accurate localization of both target and arm, the network will be totally unable to command the arm to move towards the target. This aspect of the model is in agreement with experimental results showing that kittens learning spatial relationships by means of passive displacements only are unable to perform adapted guided movements (Held and Hein 1963). Moreover, in man, greater adaptation to prism induced visual displacement occurs when active rather than passive arm movements are performed during the prismatic exposure (Held and Hein 1958). It seems therefore that the organization of the re-organization of sensorimotor relationships requires the active participation of the organism, and our sensorimotor coordination modelling takes this fundamental characteristic into account.

In humans, visuo-manual pointing without any visual control of the movement is possible only because of the existence of some visuo-proprioceptive relationships. In the model, both properties, the bisensory mapping together with the sensorimotor coordination,

makes goal-directed movement generation possible. The movements performed correspond to a visual open-loop pointing situation since, once the learning has been completed, exteroception is used solely to locate the target, the actual arm position being given in proprioceptive terms. This point is interesting because due to the proprioception, the arm trajectory can be rapidly corrected if a change in target position somehow occurs during the execution of the reaching movement. It is thus possible to induce tracking movements by moving the target from place to place in the working space.

Another property resulting from the proprioceptive feature is the fact that the initial arm configuration to some extent determines the final arm posture. This is useful here, since it reduces the ambiguity arising from the fact that many final postures might be adopted to reach one given target. Here the final posture will be that which is most similar to the initial one. The initial postural context thus determines the successive postures along the whole path, and optimizes the distance and movement time.

From the biological point of view, a satisfactory sensorimotor model should take into consideration both the behavioural and physiological aspects. One of the behavioural aspects has to do with the learning strategy. Some models perform adaptive processes in the first stage using stochastic learning, and explore the working space at random (Coiton 1987; Kuperstein 1988). During this initial period, the sensorimotor relationships are built up by simply correlating each motor output with its sensory consequences. Reaching movements can be executed in a second step, once the spatial representation has been completed. Another approach consists of implementing models in which target reaching is the specifically learned task (Massone and Bizzi 1989; Ritter et al. 1989; Dean 1990). This second strategy requires that learning be supervised by a sensory modality (vision, for instance) which must somehow be able to compute any error made in adapting the synaptic weights. The two strategies are not mutually incompatible, however, and they might be used sequentially during the learning. Another behavioural aspect worth pointing out is the fact that a correlation between proprioceptive and exteroceptive signals is required during the learning phase in order to induce the emergence of a unified sensory representation. It has been shown in fact that in kittens, if vision and proprioception are experimentally dissociated, sensorimotor coordination cannot be learned (Held and Hein 1963). As regards the physiological aspects, the present model, like others designed for similar purposes, does not claim to take into account all the processes and structures involved in sensorimotor coordination. Nevertheless, we made the basic decision to use Kohonen's algorithm because of its ability to generate topological maps. Numerous maps have been found to exist in the brain and their computational capacities have been widely recognized (Knudsen et al. 1987).

The model implementation in the form of a robot exhibits robustness, working under actual physical constraints and with noisy, non linear sensors. All in all,

these results point to the conclusion, at least provisionally, that the model is competent at performing the elementary motor tasks initially proposed.

Up to now, our model has been restricted to positional and static aspects of sensori-motricity; we shall have to try to improve the dynamic characteristics of the movements simulated. Spatio-temporal aspects need to be considered not only at the motor output level, as regards the way movements are executed, but also at the sensory level, as to how sensory inputs can induce a central representation of movements reflecting their dynamics. The next step toward improving the dynamic characteristics of our model may consist of sending the network afferent signals carrying both position and velocity components such as those naturally observed in the Ia and II fibers arising from muscle spindles (Matthews 1981; Roll and Vedel 1982).

Even if this model is no more than a limited imitation of a sensorimotor system, it seems to be complex enough to accurately reproduce the results of psychophysiological experiments in which proprioception and vision were disconnected either by modifying vision by means of prisms (Held and Hein 1958; Velay et al. 1989) or by acting on muscular proprioception by means of tendon vibration (Gilhodes et al. 1986).

Acknowledgements. We would like to thank Dr. J. Blanc for correcting the English version of the manuscript. This work was supported by French Ministry of Research and Technology, grant "Sciences de la cognition", and the E.E.C., grant "B.R.A.I.N."

References

- Coiton Y (1987) Organisation sensori-motrice: modélisation d'une logique neuromimétique. D.E.A. de Neurosciences, Marseille
- Costanzo RM, Gardner EP (1981) Multiple joint neurons in somatosensory cortex of awake monkeys. *Brain Res* 214:321-333
- Dean J (1990) Coding proprioceptive information to control movement to a target: simulation with a simple neural network. *Biol Cybern* 63:115-120
- Feldman AG (1986) Once more on the equilibrium-point hypothesis (δ model) for motor control. *J Motor Behav* 18:17-54
- Gardner EP, Costanzo RM (1981) Properties of kinesthetic neurons in somatosensory cortex of awake monkeys. *Brain Res* 214:301-319
- Georgopoulos AP (1986) On reaching. *Ann Rev Neurosci* 9:147-170
- Gilhodes JC, Coiton Y, Velay JL (1991) Sensorimotor space representation: a neuro-mimetic model. In: Paillard J (ed) *Brain and space*. Oxford University Press, Oxford pp 433-445
- Gilhodes JC, Roll JP, Tardy-Gervet MF (1986) Perceptual and motor effects of agonist-antagonist muscle vibration in man. *Exp Brain Res* 61:395-402
- Held R, Hein A (1958) Adaptation of disarranged hand-eye coordination contingent upon re-afferent stimulation. *Percept Motor Skills* 8:87-90
- Held R, Hein A (1963) Movement produced stimulation in the development of visually guided behavior. *J Comp Physiol Psychol* 56:872-876
- Jordan MI (1989) Motor learning and the degrees of freedom problem. In: Jeannerod M (ed) *Attention and performance XIII*. Erlbaum, Hillsdale pp 796-836
- Knudsen EI, du Lac S, Esterly SD (1987) Computational maps in the brain. *Ann Rev Neurosci* 10:41-65
- Kohonen T (1982) Self-organized formation of topologically correct feature maps. *Biol Cybern* 43:59-69

- Kohonen T (1984) Self-organization and associative memory. Springer Series in Information Sciences, Springer, Berlin Heidelberg New York
- Kuperstein M (1988) Neural model of adaptive hand-eye coordination for single postures. *Science* 239:1308–1311
- Lynch JC (1980) The functional organization of posterior parietal association cortex. *Behav Brain Sci* 3:485–534
- Martinetz TM, Ritter HJ, Schulten KJ (1990) Three-dimensional neural net for learning visuomotor coordination of a robot arm. *IEEE Trans Neural Net* 1:131–136
- Massone L, Bizzi E (1989) A neural network model for limb trajectory formation. *Biol Cybern* 61:417–425
- Matthews PBC (1981) Muscle spindles: their messages and their fusimotor supply. In: JM Brookhart, VB Brooks (eds) American Physiological Society, Bethesda, pp 189–228
- Mountcastle VB, Lynch JC, Georgopoulos A, Sakata H, Acuna C (1975) Posterior parietal association cortex of the monkey: command function for operation within extrapersonal space. *J Neurophysiol* 38:871–908
- Paillard J (1971) Les déterminants moteurs de l'organisation de l'espace. *Cahiers Psychol* 14:261–316
- Paillard J, Brouchon M (1974) A proprioceptive contribution to the spatial encoding of position cues for ballistic movements. *Brain Res* 71:273–284
- Prablanc C, Echallier JF, Komilis E, Jeannerod M (1979). Optimal response of eye and hand movement systems in pointing at a visual target. II. Static and dynamic visual cues in the control of hand movement. *Biol Cybern* 35:183–187
- Ritter HJ, Martinetz M, Schulten KJ (1989) Topology-conserving maps for learning visuo-motor-coordination. *Neural Net* 2:159–168
- Roll JP, Vedel JP (1982) Kinaesthetic role of muscle afferents in man, studied by tendon vibration and microneurography. *Exp Brain Res* 47:177–190
- Rumelhart DE, Hinton GE, Williams RJ (1986) Learning internal representations by error propagation. In: Rumelhart DE, McClelland JL (eds) *Parallel distributed processing*. MIT Press, Cambridge, Mass, pp 318–362
- Velay JL, Beaubaton D (1986) Influence of visual context on pointing movement accuracy. *Cahiers Psychol Cogn* 6:447–456
- Velay JL, Roll R, Paillard J (1989) Elbow position sense in man: contrasting results in matching and pointing. *Hum Mov Sci* 8:177–193
- Widrow G, Hoff ME (1960) Adaptive switching circuits. *IRE WESCON Convention Record*:96–104
- Woodworth RS (1899) The accuracy of voluntary movement. *Psychol Monogr [Suppl 13]*. MacMillan, New York

Dr. Y. Coiton
 Laboratoire de Neurobiologie Humaine
 Université de Provence
 Faculté de St. Jérôme
 C.N.R.S. U.R.A. 372
 Avenue Escadrille Normandie-Niemen
 F-13 397 Marseille Cedex 13
 France