



**HAL**  
open science

## Overview of the development of neutronics instrumentation for the EU ITER TBM at KIT

A. Klix, M Angelone, U Fischer, D Gehre, B Ghidersa, A. Lyoussi, L. Ottaviani, P. Raj, Th Reimann, D. Szalkai, et al.

### ► To cite this version:

A. Klix, M Angelone, U Fischer, D Gehre, B Ghidersa, et al.. Overview of the development of neutronics instrumentation for the EU ITER TBM at KIT. AMNT 2016 - Annual Meeting on Nuclear Technology, May 2016, Berlin, Germany. hal-01788259

**HAL Id: hal-01788259**

**<https://amu.hal.science/hal-01788259v1>**

Submitted on 8 May 2018

**HAL** is a multi-disciplinary open access archive for the deposit and dissemination of scientific research documents, whether they are published or not. The documents may come from teaching and research institutions in France or abroad, or from public or private research centers.

L'archive ouverte pluridisciplinaire **HAL**, est destinée au dépôt et à la diffusion de documents scientifiques de niveau recherche, publiés ou non, émanant des établissements d'enseignement et de recherche français ou étrangers, des laboratoires publics ou privés.

# Overview of the development of neutronics instrumentation for the EU ITER TBM at KIT

A. Klix<sup>1</sup>, M. Angelone<sup>2</sup>, U. Fischer<sup>1</sup>, D. Gehre<sup>3</sup>, B. Ghidersa<sup>1</sup>, A. Lyoussi<sup>4</sup>, L. Ottaviani<sup>5</sup>,  
P. Raj<sup>1</sup>, Th. Reimann<sup>1</sup>, D. Szalkai<sup>1</sup>, and K. Tian<sup>1</sup>

<sup>1</sup> Association KIT-EURATOM, Karlsruhe Institute of Technology, Germany

<sup>2</sup> Associazione ENEA-EURATOM sulla Fusione, ENEA C.R., Frascati, Italy

<sup>3</sup> Technical University of Dresden, Germany

<sup>4</sup> CEA, DEN, DER, Instrumentation Sensors and Dosimetry Laboratory, Cadarache, France

<sup>5</sup> Aix-Marseille Université, Marseille, France

## Abstract

Test Blanket Modules (TBM) will be installed in ITER with the aim to investigate the nuclear performance of different breeding blanket concepts.

As partner of the European Consortium on Nuclear Data and Measurement Techniques in the framework of several F4E specific grants and contracts, KIT and ENEA have investigated ways to integrate neutron flux detectors into the TBM considering in particular mechanical restrictions and the harsh environment of the TBM. In the frame of ongoing research, several candidate neutron flux measurement techniques are investigated for their suitability to and operability under the harsh environment conditions in the TBM. The work at KIT focusses on a neutron activation system, self-powered detectors and silicon carbide detectors.

## 1. Introduction

Test Blanket Modules (TBM) as part of six test blanket systems (TBS) are expected to be installed in three equatorial ports of ITER [1], the international fusion research reactor under construction in the Provence. Two breeding blanket concepts, the Helium-Cooled Lithium-Lead (HCLL) and Helium-Cooled Pebble Bed (HCPB) breeding blanket will be tested by the EU in ITER equatorial port #16. The objective of these tests is, among others, to investigate experimentally the performance of different tritium breeding blanket concepts and obtain data to check the capabilities of simulation codes for radiation transport, thermohydraulics and others which are indispensable tools for the design of breeding blankets.

An important aim of dedicated neutronics TBM experiments will be to assess the prediction accuracy of nuclear responses in an environment more closely resembling that of a future fusion power reactor than could be achieved so far with existing neutron irradiation facilities. Quantities to be measured are for example tritium production rates and nuclear heating. These quantities have to be related to the time-dependent neutron flux through the TBM to be measured with high accuracy. It is desirable to measure the neutron flux at least in coarse neutron energy groups such as thermal, fast and at DT fusion peak energies. There are currently only a few measurement techniques available which might be compatible with the harsh environment conditions in the TBM during operation. The operating conditions are characterized by high temperatures (350-650 °C), strong electromagnetic fields and, depending on plasma scenario, intense ionizing radiation.

A dedicated program to develop and qualify neutron and gamma flux detectors for application in the European TBM is pursued by a collaboration of ENEA and KIT for several years. The work focusses on self-powered neutron/gamma detectors (SPND, SPGD; in general self-powered detector - SPD), silicon carbide and diamond detectors, and a neutron activation system (NAS). Here we will summarize the activities on the SPD, silicon carbide detectors and the NAS.

## 2. Neutron activation system

A NAS is based on a transport system, usually pneumatically driven, which carries small activation probes to a position where the neutron flux is to be measured. After a fixed irradiation time the activation probe is sent to a detection system for measurement of the induced activity. The neutron flux can then be calculated from the irradiation time, half-life of the particular induced radio isotope, the known reaction cross section and the mass of the activation probe. NAS are applied in fission reactors [2] as well as current research fusion reactors [3,4 etc.]. ITER will be equipped with a neutron activation system as well which will serve for the measurement of the neutron yield.

A NAS for the TBM has several advantages over other neutron flux measurement techniques. It allows to incorporate several activation materials in one probe and delivers therefore more information on the neutron spectrum and it is radiation hard. Since the primary purpose is to measure the neutron flux in a particular position it is not required to calibrate the NAS, only the counting station for the induced activity requires calibration. The neutron flux measured in this way is then already an absolute value. The activation probes can be easily replaced, there are no concerns regarding burn-up effects and their compensation.

However there are some disadvantages and challenges to be faced. The irradiation ends are located in regions of the TBM with temperatures of at least 350 °C while most of the activation probe transportation lines are at room temperature. The transportation lines must penetrate through several interfaces, the TBM is located inside the reactor vessel. The transportation time of the activation probes from the irradiation end to the counting station are on the order of a few seconds, and irradiation times of at least a few tens of seconds should be expected. The time resolution of the neutron flux measurement is therefore low to moderate. Each measurement position at least in toroidal and poloidal directions requires a separate transportation line so that only a very few measurement positions can be realized.

A preliminary engineering assessment [5] was done to investigate a pneumatic transport system suitable to transport activation probes from a storage to selected irradiation ends (IE) inside the TBM, extract them after irradiation and send them to a gamma-ray counting station and then to a disposal. A general layout of the system is shown in Fig. 1. The activation probes are driven by helium gas, and the motion of the probes is regulated by controlling the gas pressure in front and behind the probe. Measurements with DT neutrons from the accelerator-based intensive neutron generator of Technical University of Dresden (TUD-NG) were performed to test a stack of activation foils. In some of these tests a neutronics mockup of the HCLL (Helium-Cooled Lithium-Lead) TBM was utilized. A picture of the corresponding setup together with a typical recorded multifoil gamma-ray spectrum is presented in Fig. 2. The irradiation position was approximately 20 cm away from the tritium target of TUD-NG and surrounded by the mockup. The foil stack consisted of gold, aluminum, cerium and chromium foils. It was possible to keep the irradiation time comparably

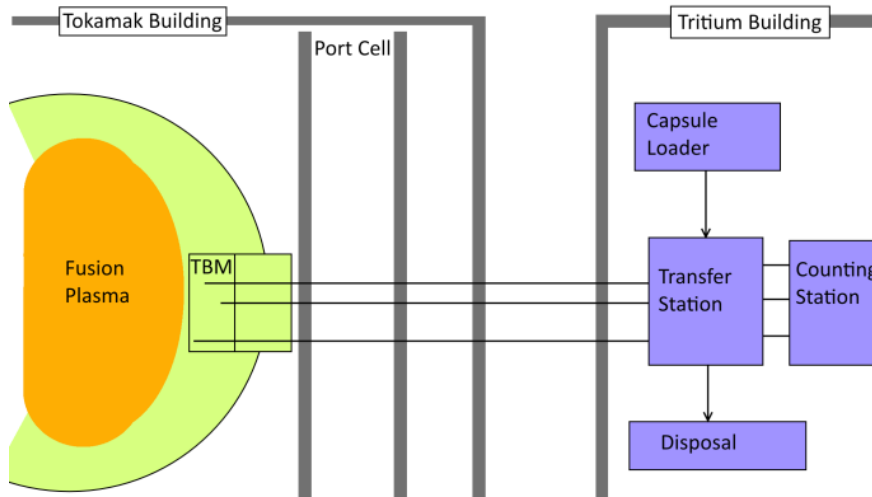

Fig. 1. Schematic general layout of TBM-NAS.

short with 2 min which is of the same order as the half-lives of most radio nuclides of interest in the activation probe. The spectrum shown in Fig. 2 was obtained after 5 min of gamma-ray measurement time. The saturation activities computed from the recorded gamma-ray spectrum together with their estimated uncertainties were further processed with the few-channel version of the MAXED code [6,7] and response functions generated from EAF-2010 [8] activation data. Uncertainty analysis was performed with the IQU\_FC33 code [7] and the uncertainties of the gamma-ray measurement as an input. The neutron spectrum computed in this way with the corresponding uncertainties is shown in Fig. 3.

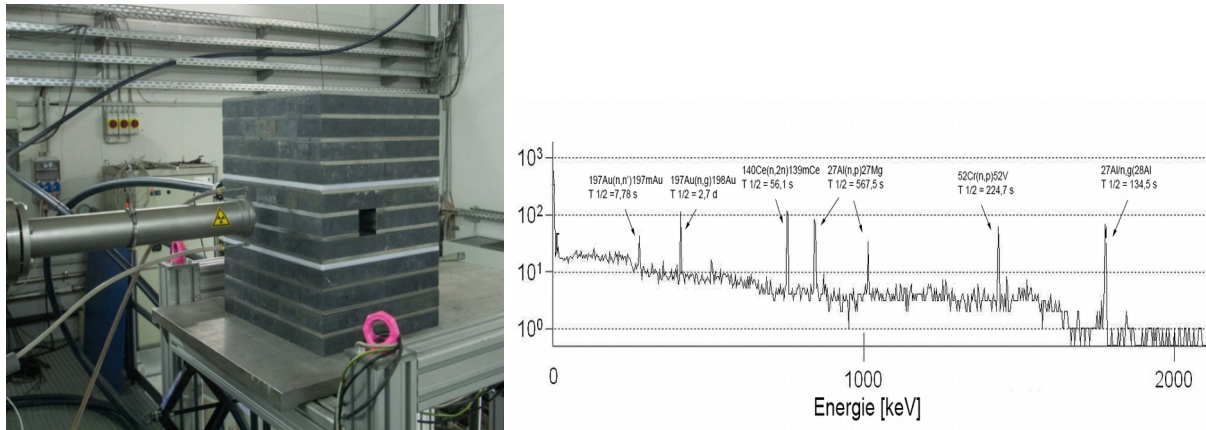

Fig. 2: Experimental setup for testing of activation foils at TUD-NG and example of a recorded gamma ray spectrum with multifoil measurement.

### 3. Silicon carbide detector

Silicon carbide is a semiconductor material with a wide band gap (3.2 eV) and a high displacement energy. Therefore a detector made of SiC can operate at elevated temperatures and is more radiation-tolerant than Si based electronics. Moreover, SiC-based discrete electronics is a mature technology. Future use and application of SiC detectors is expected for nuclear reactor monitoring, safeguards, oil&gas prospection, non-destructive assays and others [9,10,11].

Spektrale Neutronenflussdichte

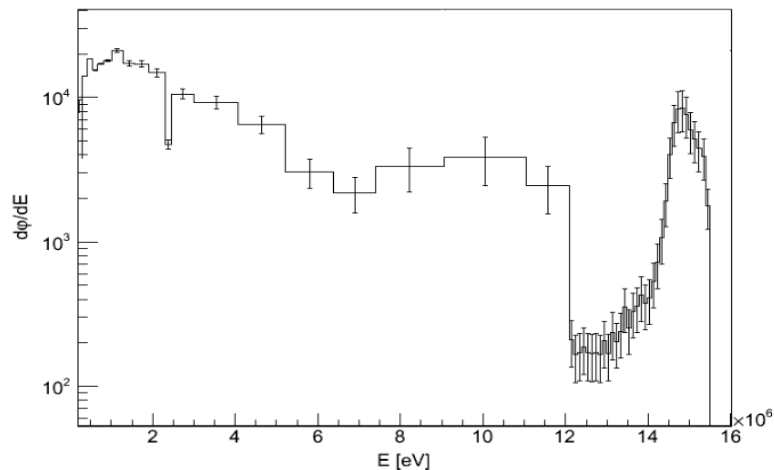

Fig. 3. Unfolded neutron spectrum and uncertainties of the measurement in the HCLL TBM mockup TBM.

A plain SiC detector is sensitive to fast neutrons through scattering reactions on Si and C nuclei as well as nuclear reactions emitting charged particles. In particular, the  $^{12}\text{C}(n,\alpha)^9\text{Be}$  reaction on carbon leading to the emission of an alpha particle with definite energy is an important mechanism of signal generation in such a detector, provided the energy of the incoming neutron is sufficiently high,  $>7$  MeV.

Sensitivity to thermal neutrons can be achieved by adding a lithium or boron containing component to the detector. These additions will emit alpha particles under thermal neutron irradiation via the reactions  $^6\text{Li}(n,\alpha)\text{T}$  or  $^{10}\text{B}(n,\alpha)^7\text{Li}$  and generate a signal in the detector. If the lithium or boron component is present as a layer then the thickness of the sensitive volume of the detector could be kept small, a few  $\mu\text{m}$ , to ensure only full stop of the alphas. This will reduce response to Compton electrons from gamma interactions and charged particle emissions from reactions with fast neutrons and hence improve the signal-to-noise ratio to thermal neutrons. In particular, Compton electrons would only be able to deposit a small part of their energy in the thin sensitive region and could be eliminated in the detector signal by simply applying a threshold to the output signal.

In the frame of the ISMART project [12], a collaboration of several European research institutions and universities, KIT was working on the qualification of SiC detectors for application in the TBM. The detectors produced as part of the project were plain SiC diodes as well as diodes with a boron implantation. Fig. 4 shows an example of an ISMART SiC diode together with a typical pulse height spectrum under DT neutron irradiation.

Testing of the diodes was performed mostly in the thermal neutron field of the BR1 research reactor at SCK\*CEN in Mol and in the DT neutron field of TUD-NG [13,14]. The tests were done at room temperature in both facilities and also at elevated temperatures up to  $500^\circ\text{C}$  with TUD-NG. The signal from the diode was fed into a charge-sensitive preamplifier with a high gain and then further processed with a digitizer and multi-channel analyzer DT5780 from CAEN S.p.A.

An important issue was the investigation of the diode properties at TBM-relevant temperatures under fast neutron irradiation. A heating system for the SiC diodes was set up at TUD-NG which allowed to control the temperature of the diode up to  $500^\circ\text{C}$ . Although no long-term irradiation tests could be performed with the neutron

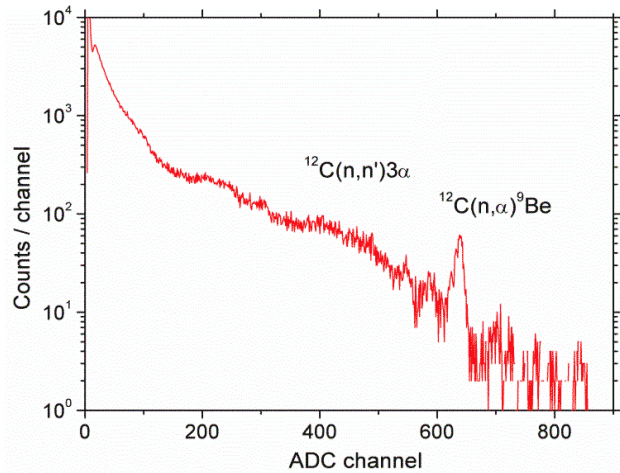

Fig. 4: Typical ISMART SiC diode (here approx. 5 mm × 5 mm) and example of a recorded pulse height spectrum under DT neutron irradiation.

generator, irradiations were done over a few hours with interruption. These tests showed a stable behaviour of the diodes even at high temperatures. Moreover, it could be shown that they still keep spectroscopic behaviour at temperatures up to 500 °C. It was necessary to reduce the applied bias voltage with increasing temperature to keep the operation stable. This led to a smaller sensitive volume and a reduced fast neutron count rate with increasing temperature, see Fig. 5.

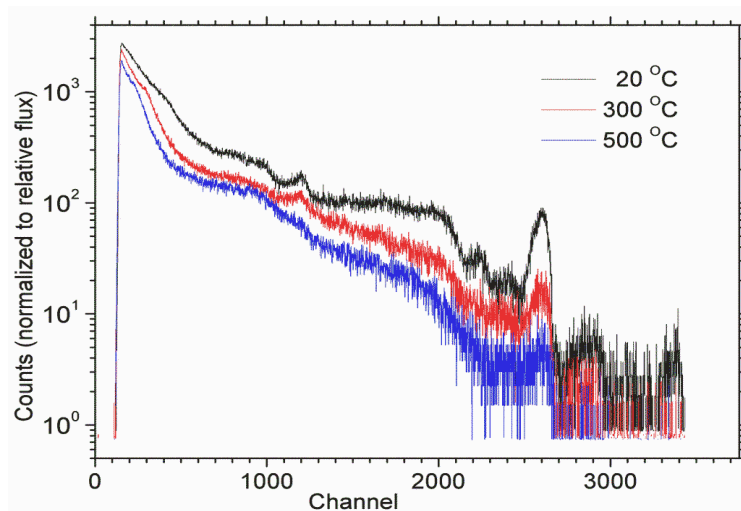

Fig. 5: Pulse height spectrum under DT neutron irradiation at different detector temperatures.

#### 4. Self-powered detectors

SPND are based on the measurement of the small electric current due to high-energy electron emission from Compton interactions of prompt gamma-rays under neutron irradiation or in photon fields or high-energy electron emission from beta decays under neutron irradiation. SPND are robust and of a simple design. They are well suited for harsh environments and routinely used to measure neutron fluxes in the core of fission reactors. Therefore they appear to be interesting also for application in the TBM.

In general, a SPD consists of three major parts. The so-called emitter is the sensitive element. It emits electrons by the processes mentioned above. The emitter is separated from an outer sheath called the collector by an insulator, usually alumina or magnesia. There are several additional processes which introduce currents in this system, however, the net current measured between emitter and collector is dominated by the energetic electron emission from the two neutron processes described above in commercially available SPND. These SPND are tailored to measure thermal neutron fluxes and utilize thermal neutron reactions with very high cross sections such as  $^{103}\text{Rh}(n,\gamma)$ .

In the TBM the situation becomes more complicated since there is an interest to measure not only the thermal neutron flux but also the fast neutron and photon flux. However, at fast neutron energies, interaction cross sections are orders of magnitude less than the effective thermal cross sections utilized in fission reactor SPND. Therefore the expected currents are also much smaller. As it turns out from experiments performed with several emitter materials selected for testing with fast neutrons, the electric current contribution from the beta activation by fast neutrons are of similar order as the current contribution from other radiation-induced effects. Several criteria need to be considered to select candidate emitter materials for further tests [15]:

- 1.) a high saturation activity if beta-decay based or a high probability for emission of high energy prompt gamma rays if based on Compton electrons
- 2.) high energy of emitted beta electrons / Compton electrons for a good signal-to-noise ratio
- 3.) short half-life if based on beta decay for fast responses

Three commercially available cylindrical SPND made by Thermocoax have been tested in fast neutron fields at the Frascati Neutron Generator (FNG, ENEA Frascati) and the TAPIRO reactor (ENEA Cassacia). Their emitters were rods of rhodium, vanadium and cobalt. Only from the rhodium-based SPND a measurable signal was obtained at TAPIRO. From this measurements and an activation analysis a lower limit of saturation activity was calculated which allows to restrict the list of candidate emitter materials for fast neutrons to a few members.

Since the neutron interaction cross sections at neutron energies in the MeV range up to fusion peak energies are much smaller than at thermal energies, the expected current due primarily to neutrons is much lower than in the fission reactor case and of similar order as currents induced by other radiation effects. This is not necessarily bad

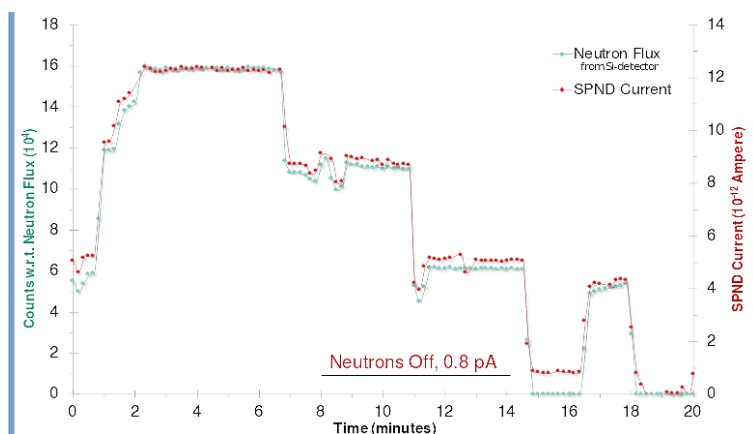
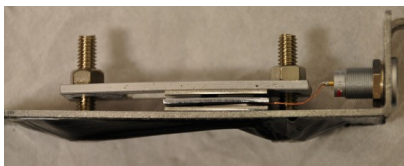

Fig. 6: Design of the sandwich-style test SPDs and example of the electric current vs. relative neutron flux density.

*as long as it can be shown* that the SPND signal in the TBM depends in a predictable manner on the neutron flux. Note that these other radiation effects might be localized inside the detector or due to the photon flux from outside the detector.

Testing of some of the candidat materials selected previously under DT neutron irradiation have been performed at TUD-NG, and further tests are underway [16]. The tests are done with a special sandwich-style SPD design. This design allows to vary emitter, insulator and collector materials. Since the neutron source of TUD-NG has the shape of a small disk of approx. 1 cm diameter the design also helps to keep more active SPND material close to the neutron source and hence in a neutron field with high neutron flux as compared to the typical cylindrical SPND design.

Fig. 6 shows a typical setup of a sandwich-style test detector as well as the measured current at different DT neutron flux levels of a beryllium-based test detector. The measured current is to a large extend proportional to the neutron flux.

Further tests and simulations are underway to quantify contributors to the generated current signal.

## 5. Summary

The neutron flux is a basic parameter for many TBM experiments, in particular for the neutronics measurements in the TBM phase dedicated for neutronics experiments and tests of the TBS at ITER. The environmental conditions in the TBM are not favorable for any kind of diagnostic system, however, an effort is underway in the EU to develop and qualify a selection of detector types for the TBM. Among them is a NAS, SPND and detectors based on silicon carbide electronics.

The NAS can draw on available technology for its main components such as a pneumatic transport system and off-the-shelf gamma-ray spectroscopy equipment. A major challenge is the scarce space available inside the TBM, the necessity to have tubing with moving parts inside and gas flow from inside the TBM to the distributor and gamma spectroscopy station. The layout and design must comply with TBM design regulations as well as ITER regulations. As for the neutronics point of view, the experimenter will in principle be free to choose activation materials suited for the particular experiment/measurement.

Silicon carbide detectors have been tested successfully at temperatures up to 500 °C under DT neutron irradiation. These detectors were fabricated by the ISMART project with and without a conversion layer for thermal neutrons. High-fluence irradiations with DT neutrons are under preparation.

SPND for thermal neutrons are available commercially and are mature technology for fission reactors. The application of SPND in the TBMs poses some challenges since the small currents primarily due to neutrons are on a similar order as currents induced by other radiation effects. In addition, there will be strong magnetic fields and overall an unfavorable EM environment in the TBM. Candidate materials for SPND sensitive for fast neutrons are under investigation. A Cr-based detector was prepared by ENEA Frascati and beryllium and vanadium based detector designs are currently under investigation at KIT.

## 6. Acknowledgement

This work was supported by Fusion for Energy under the service contract No. F4E-OMF-331-02-01-02 and under the grant contracts Nos. F4E-FPA-395-01 and F4E-GRT-056.2. The views and opinions expressed herein reflect only the author's views. Fusion for Energy is not liable for any use that may be made of the information



contained therein. The authors would like to acknowledge the support from the ISMART Project. ISMART is funded by KIC InnoEnergy.

## 7. References

- [1] L.M. Giancarli, M. Abdou, D.J. Campbell, et.al., "Overview of the ITER TBM Program," *Fusion Engineering and Design*, 87 (2012) 395-402
- [2] E. Schrüfer (Ed.), "Strahlung und Strahlungsmesstechnik in Kernkraftwerken," Elitera-Verlag, Berlin 1974, pp. 351-354
- [3] O. Jarvis et al., "Use of Activation Techniques for the Measurement of Neutron Yield from Deuterium Plasmas at Join European Torus," *Fusion Technology*, Vol. 20, Nov. 1991
- [4] M.S. Cheon, Y.S. Lee, A.C. England, H.S. Kim, S. Pak, C.R. Seon, H.G. Lee, "Diagnostic neutron activation system for KSTAR," *Proceedings 2<sup>nd</sup> International Workshop on Fast Neutron Detectors and Applications*, 6.-11. Nov. 2011, Ein Gedi, Israel; doi:10.1088/1748-0221/7/05/C05009
- [5] K. Tian, P. Calderoni, B.-E. Ghidersa, A. Klix, „Feasibility Study of a Neutron Activation System for EU Test Blanket Systems," *Fusion Engineering and Design*, 109–111 (2016) 1517–1521
- [6] M. Reginatto, P. Goldhagen, "MAXED a Computer Code for the Deconvolution of Multisphere Neutron Spectrometer Data Using the Maximum Entropy Method," USDEo Report EML-595, 1998
- [7] M. Reginatto, "The 'few-channel' unfolding programs in the UMG package, UMG package, version 3.3, PTB, 2004
- [8] <http://www.oecd-nea.org/janis>
- [9] H. Amharrak, J. Di Salvo, A. Lyoussi, et al., "Analysis and Recent Advances in Gamma Heating Measurements in MINERVE Facility by Using TLD and OSLD Techniques," *IEEE Trans. Nucl. Sci.*, vol. 59, no. 4, pp. 1360-1368
- [10] D. Fourmentel, Ch. Reynard-Carette, A. Lyoussi, et al., "Nuclear Heating Measurements in Material Testing Reactor: A Comparison Between a Differential Calorimeter and a Gamma Thermometer," *IEEE Trans. Nucl. Sci.*, vol. 60, no. 1, pp. 328-335
- [11] A. Lyoussi, J. Romeyer Dherbey, F. Jallu, E. Payan, A. Buisson, G. Nurdin, J. Allano, "Transuranic waste assay detection by photon interrogation and on-line delayed neutron counting," *Nuclear Instruments and Methods in Physics Research B* 160 (2000) pp 280-289
- [12] [http://www.innoenergy.com/innovationproject/our-innovation-projects/i\\_smart](http://www.innoenergy.com/innovationproject/our-innovation-projects/i_smart)
- [13] D. Szalkai, R. Ferone, D. Gehre, F. Issa, A. Klix, A. Lyoussi, L. Ottaviani, T. Rücker, P. Tüttö, V. Vervisch, „Detection of 14 MeV neutrons in high temperature environment up to 500 OC using 4H-SiC based diode detector," *Conference Record ANIMMA-2015*, 20.-24. April 2015, Lisbon, Portugal
- [14] F. Issa, V. Vervisch, L. Ottaviani, D. Szalkai, L. Vermeeren, A. Lyoussi, A. Kuznetsov, M. Lazar, A. Klix, O. Palais, and A. Hallen, "Radiation Silicon Carbide Detectors Based on Ion Implantation of Boron," *IEEE Trans. Nucl. Sci.*, vol. 61, no. 4, pp. 2105–2111, Aug. 2014
- [15] M. Angelone, A. Klix, M. Pillon, P. Batistoni, U. Fischer, A. Santagata, "Development of self-powered neutron detectors for neutron flux monitoring in HCLL and HCPB ITER-TBM," *Fus. Eng. Des.*, vol. 89, pp.2194-2198, 2014
- [16] P. Raj, M. Angelone, U. Fischer, A. Klix, "Self-Powered Detector for Test Blanket Modules in ITER," *Proceedings of 2016 IEEE NSS/MIC 2016*, 29. Oct. - 5. Nov. 2016, Strasbourg, France