



**HAL**  
open science

## Structuring residuals by faults structural decoupling from bicausal diagnostic bond graph

K Sia, A Namaane, N. M'Sirdi

► **To cite this version:**

K Sia, A Namaane, N. M'Sirdi. Structuring residuals by faults structural decoupling from bicausal diagnostic bond graph. International Conference on Bond Graph, ICBGM 2016, Jul 2016, Montreal, Quebec, Canada, Canada. hal-01967650

**HAL Id: hal-01967650**

**<https://amu.hal.science/hal-01967650v1>**

Submitted on 1 Jan 2019

**HAL** is a multi-disciplinary open access archive for the deposit and dissemination of scientific research documents, whether they are published or not. The documents may come from teaching and research institutions in France or abroad, or from public or private research centers.

L'archive ouverte pluridisciplinaire **HAL**, est destinée au dépôt et à la diffusion de documents scientifiques de niveau recherche, publiés ou non, émanant des établissements d'enseignement et de recherche français ou étrangers, des laboratoires publics ou privés.

# Structuring residuals by faults structural decoupling from bicausal diagnostic bond graph

K. SIA, A. NAMAANE, N.K. M'SIRDI

Aix Marseille Université, CNRS, ENSAM, Université de Toulon, LSIS UMR 7296, France.  
Ave. Escadrille Normandie-Niemen Henri Marseille cedex 20, 13397

Kamel.Sia, Aziz.Naamane, N.M'sirdi@Lsis.org

## ABSTRACT

This paper presents a new graphical algorithm to carry out the rule of structured residuals, in order to enhance the internal component faults isolation of linear and linearized dynamical systems. For this aim, it is shown that the diagnostic bond graph; which allows generating residuals by using the ARRs scheme also allows handling their structuration. The residuals structuration is achieved through the fault structural decoupling leading to selective sensitivity to subsets of faults. To deal with the fault structural decoupling, a new bond graph bicausal element is introduced; it is termed Effort and Flow Propagator (or join) element. This approach is within the frequency domain, so, the process of residuals generation is homogenized by using solely the rule of the transfer function in  $s$ -form.

**Keywords:** Component Faults Detection and Isolation (CFDI); isolation enhancement; structured residuals; structural analysis; bond graph; diagnostic bond graph (DBG); fault decoupling; unknown input decoupling; analytical redundancy relations (ARRs).

## 1. INTRODUCTION

The problem addressed here is the isolation enhancement of the internal component (or plant) faults by performing the fault structural decoupling, from linear and linearized bond graphs [2, 13, 23]. Regarding the output detectors (or sensors) and the power sources (or actuators), they are supposed either working normally, or they have their own FDI systems [4, 28]. In the considered problem, the complexity is due to the large number of internal components of dynamical systems w.r.t. that of output detectors. Face this complexity, thanks to the powerful rule of the structured residuals [11]; the fault isolation can be enhanced. It is then possible to generate the primary residuals, directly from the rearranged original (or initial) model. And in order to enhance the faults isolation, the primary residuals are transformed, by structuring them to be sensitive to specific faults, while being insensitive to others. So doing so, the effects of faults upon the residuals become distinguishable, and the faults can be isolated.

The task of residuals structuration is carried out off-line during the phase of residuals generation, it is performed by means of faults decoupling [4, 5, 8, 11, 12], and the resulted residuals are termed secondary residuals [11, 14].

For the aim of internal component FDI problem formulation, figure (1) recalls the arrangement of the basic elements of the bond graph model, where the Simple Junction Structure (SJS) is chosen [32]. It is easy to understand that the internal physical components of dynamical systems are mapped in the following discrete set  $\{I, C, R, TF, GY\}$ ; where each basic element has a specific treatment of the incoming energy. Indeed, these elements share a common property; their behavioural constitutive laws involve similar quantities; i.e. an output variable, an input variable and a physical parameter.

It is assumed that parametric (or multiplicative) as well as structural (or additive) component faults acting, in a similar way, as unknown inputs supplied by power sources, see figure 1. So then, a new fault structural decoupling algorithm is proposed to generate sufficient secondary residuals to enhance the component faults isolation. It is based on the annihilation of the influences of non-isolated faults on variables of the DBG that furnish ARRs, and its main tool is the bond graph bicausality concept [10].

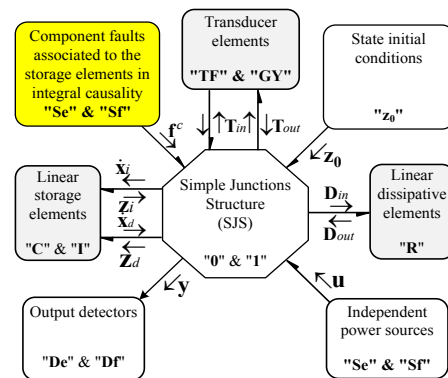

Figure 1. SJS of a faulty linear bond graph

In graphical models based FDI literature, there are researches that have addressed the problem of component fault isolation enhancement by fault decoupling. In [1], assuming the modeling of component faults as unknown inputs, thus the inverse bond graph model is used to allow output detectors to the specified component faults inversion, consequently the faults can be estimated and their

effects can be decoupled. Noting that, here the computational derivative causality is preferred. In [9] and [31], still with the same fault hypothesis modeling as previously, but by using the Unknown Input Observer (UIO) scheme from bond graphs; where for each component fault, a single UIO is dedicated to its estimation. Also, for the same issue of fault isolation enhancement, but this time by using the bipartite graph model [29], deep knowledge about the time-dependency of faults (abrupt fault, incipient fault) are integrated in faults modeling to get further ARRs allowing decoupling the effects of non-isolated faults [6] [7]. In this case, the isolability matrix is used to identify which faults require further modeling effort.

Moreover, the bond graph computational tools used in this paper are shared by some researches, but for the purpose of ARRs generation; so that in [24], the bicausality benefit; which is separating the causality assignment to the effort and flow variables of the same power bond, is employed especially to handle nonlinear constitutive laws singularities. Likewise as in [2], the preferred integral causality is assigned to the diagnostic bond graph to avoid computing the unknown variables arising after the construction of the fault indicators (or residual sinks).

This paper is organized as follows: Section II introduces the four hydraulic tanks system benchmark, through which the development of the CFDI algorithm is processed. It provides the bond graph model and it models the component faults to get the faulty behavior. Section III generates the primary residuals and particularly it points out their insufficiency to ensure the component faults isolation. Section IV presents the core of this paper, that is, the generation of secondary residuals by structural decoupling the primary residuals from non-isolated faults, where the bicausal diagnostic bond graph is the fundamental used tool. Section V runs the simulation example to prove the theoretical developments. Finally, section VI concludes with some benefits of the faults structural decoupling from the bond graph modeling.

## 2. BENCHMARK SYSTEM TO CFDI SYSTEM DESIGN

The nonlinear four hydraulic tanks system proposed for CFDI system design is shown in figure (2). The tanks  $T_i$ ; with  $i = 1 \dots 4$ , have the same section  $S = 0.3m^2$  and they are coupled by nonlinear valves. The flow rate through the valve is given by Torricelli law:  $Q_i^2 = K(L_i - L_{i+1})$ ; with  $Q_i$  is in  $(m^3/s)$ ,  $L_i$  and  $L_{i+1}$  are liquid levels in  $(m)$  on either side of the valve and  $K = 4 \times 10^{-6}$ .

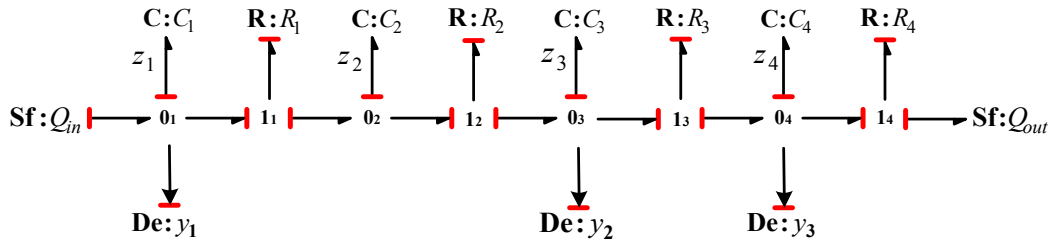

Figure 3. Linearized bond graph model B in integral causality of the four hydraulic tanks system.

The input of the hydraulic system is the inflow  $Q_{in}$ :

$$\mathbf{u} = Q_{in} = 0.001 + 4 \times 10^{-4} \sin(t) \quad (1)$$

The linearized bond graph model around the equilibrium point, denoted  $\mathbf{B}$ , is shown by figure (3). It should be noted that, the prime symbol standing for linearization is omitted for equations clarity. The tanks are represented by linear storage C-elements with parameters,  $C_i = S$ ; with  $i = 1 \dots 4$ , but the nonlinear valves become linear and they are represented by R-elements with the same parameter  $R = 500 m^5/s^2$ .

Let the complementary state variables at the storage C-elements in integral causality be denoted  $z_i$ ;  $i = 1 \dots 4$ , and they represent liquid levels in the corresponding tanks:

$$\mathbf{z} = (z_1 \ z_2 \ z_3 \ z_4)^t \quad (2)$$

The output variables are furnished by effort detectors  $\mathbf{De}$ :  $y_i$ ; with  $i = 1 \dots 3$ , and they are defined as follows:

$$\mathbf{y} = (y_1 \ y_2 \ y_3)^t = (z_1 \ z_3 \ z_4)^t \quad (3)$$

While, the input variable is supplied by the unique flow power source  $\mathbf{Sf}$ :  $Q_{in}$ .

Only for the clarity of the bond graph model, the state initial conditions,  $\mathbf{z}_0$ , are not represented. Still, it should be noted that, they can be modeled as power sources acting on the output variables of storage elements,  $\mathbf{I}$  and  $\mathbf{C}$ , in integral causality by means of adequate simple junctions [2, 10].

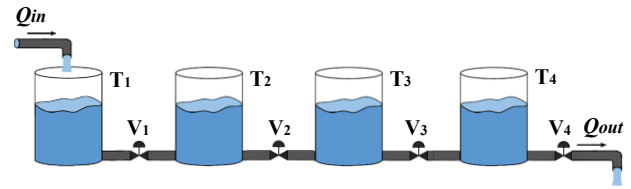

Figure 2. Four hydraulic tanks system.

### 2.1. Internal component (or plant) faults modelling

In the presence of the internal component (or plant) faults, the bond graph model of the faulty behaviour is depicted by figure 4. It displays the parametric faults,  $\Delta R_i$  and  $\Delta C_i$ ; with  $i = 1 \dots 4$ , they are modelled by additive increments added to the nominal parameter,  $R_i$  and  $C_i$ , and they represent changes in physique properties of the components [24]. Moreover, it is taken into account the structural faults that are modelled as flow sources,  $\mathbf{Sf}$ :  $f_{in,ci}$ ; with  $i = 1 \dots 4$ , they acting as inputs to the storage C elements and they represent leakage in different tanks [24].

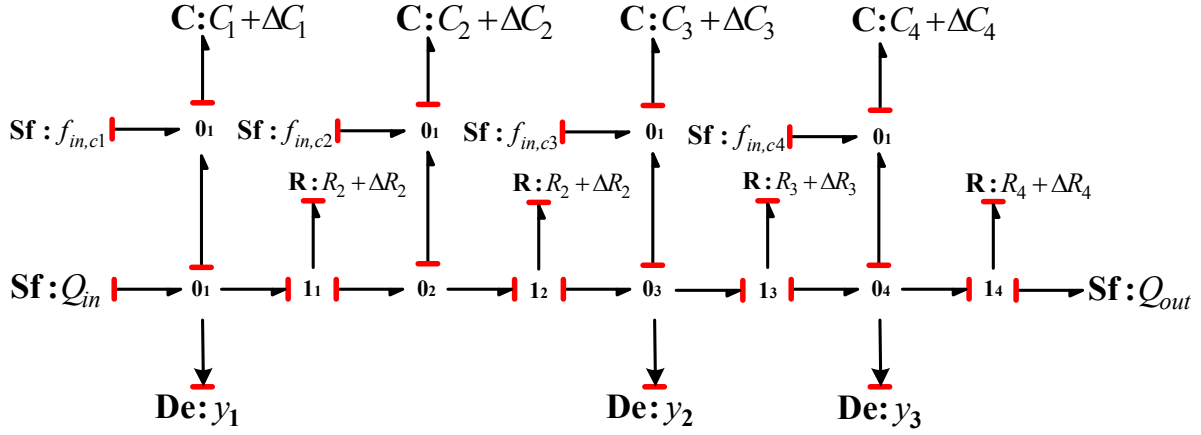

Figure 4. Faulty linearized bond graph  $\mathbf{B}$  in integral causality of the four hydraulic tanks system.

The individual treatment of each fault of each component makes the problem of faults isolation very complex to formulate [5, 12]. To overcome this complexity, the components are regrouped in a set of equivalence classes, where each equivalent class involves bond graph elements linked by causal loop of order 1 with a storage element in integral causality (in this case,  $\mathbf{C}$  elements), and it is recognizable by the label of this storage element. The table (1) highlights the different found equivalence classes.

Storage element in integral causality	Equivalence classes	Sets of basic elements
$C_1$	$[C_1]$	$\{C_1; R_1\}$
$C_2$	$[C_2]$	$\{C_2; R_1; R_2\}$
$C_3$	$[C_3]$	$\{C_3; R_2; R_3\}$
$C_4$	$[C_4]$	$\{C_4; R_3; R_4\}$

Table 1. Equivalence classes of components

To each storage element in integral causality,  $C_i$ ; with  $i = 1 \dots 4$ , a set of component faults is associated, it includes at once the parametric and structural faults of the components belonging to its own equivalence class and they are recognized as its own faults, denoted  $f_{ci}^c$ ; with  $i = 1 \dots 4$ . The table (2) highlights the component faults associated to the storage elements.

Faults of storage element in integral causality	Sets of component faults associated to storage element in integral causality
$f_{c1}^c$	$\{f_{in,c1}^c; \Delta C_1; \Delta R_1\}$
$f_{c2}^c$	$\{f_{in,c2}^c; \Delta C_2; \Delta R_1; \Delta R_2\}$
$f_{c3}^c$	$\{f_{in,c3}^c; \Delta C_3; \Delta R_2; \Delta R_3\}$
$f_{c4}^c$	$\{f_{in,c4}^c; \Delta C_4; \Delta R_3; \Delta R_4\}$

Table 2. Faults associated to storage elements in integral causality

In the end of the component faults modelling task, the simplified faulty linearized bond graph model is depicted by figure (5), where the possible component faults associated to the storage elements in integral causality are modelled as unknown inputs supplied by flow power sources  $\mathbf{Sf}: f_{ci}^c$ ; with  $i = 1 \dots 4$ , and they acting at junctions to which the storage elements in integral causality are attached.

**Remark 1.** For clarity, henceforth, the component faults associated to the storage elements in integral causality are simply called component faults and the flow power sources representing them are simply called component fault sources.

Since the linearized bond graph model,  $\mathbf{B}$ , contains four storage elements in integral causality; there are four component faults to be detected and isolated; which are regrouped and put in the following component faults vector:

$$\mathbf{f}^c = (f_{c1}^c \quad f_{c2}^c \quad f_{c3}^c \quad f_{c4}^c)^t \quad (4)$$

From now, the problem of component faults detection and isolation from linear and linearized bond graphs is posed and the rule of structured residuals is chosen to ensure the fault isolation.

### 3. PRIMARY RESIDUALS GENERATION

The Diagnostic Bond Graph (DBG), which is denoted here  $\mathbf{B}$ , is introduced in [16, 24]; it is the basis of residuals generation based on ARRs scheme. It is established by simple rearrangement of the causality in the original bond graph model  $\mathbf{B}$ , in order to generate straightly analytical constraints equal to zero [19]. The causality rearrangement is obtained by substituting the output detectors  $\mathbf{De}: y_i$ ; with  $i = 1 \dots 3$ , by modulated power sources  $\mathbf{M}\mathbf{S}\mathbf{e}: y_i$ ; with  $i = 1 \dots 3$ , where the modulate signals are the measured outputs; see for this figure (6).

Noting that the diagnostic bond graph,  $\mathbf{B}$ , is assigned the preferred integral causality, in order to carry out the rule of the transfer function in  $s$ -form (see rule 1, in the appendix).

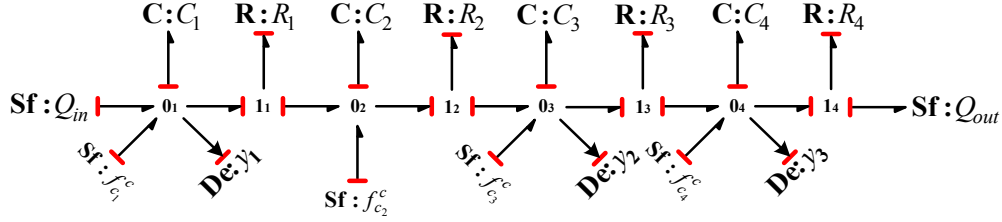

Figure 5. Component faults modeling as unknown inputs supplied by flow power sources.

For the sake of CFDI problem formulation [25, 26], the new emerged modulated power sources are termed imposed output sources, and the junctions resulting after the redistribution of the causal strokes are termed null junctions and noted  $\mathbf{Nj}$ ; these latter are so called, because their net power are in principle identically zero. The response of the bond graph model to the solicitation of the imposed output sources are termed null signals and denoted  $\mathbf{Ns}$ .

**Remark 2.** The DBG  $\tilde{\mathbf{B}}$  is a generalized bond graph, due to the presence of storage elements (**I** and **C**) in derivative causality. Therefore, this property must be considered by the algorithms of the analytical models derivation.

The null junctions are labeled by the number of their original junctions from which they are issued:

$$\mathbf{Nj} = \{Nj_{01}, Nj_{03}, Nj_{04}\} \quad (5)$$

Whereas, the null signals are labeled by the same number of the null junctions to which they belong and they are put in a vector:

$$\mathbf{Ns} = (Ns_{01} \quad Ns_{03} \quad Ns_{04})^t \quad (6)$$

Through the process of the null signals construction, the following important remark can be made.

**Remark 3.** It is possible to say that the null signals, in order,  $Ns_{01}$ ,  $Ns_{03}$  and  $Ns_{04}$  are due respectively to the output detectors,  $\mathbf{De}:y_1$ ,  $\mathbf{De}:y_2$  and  $\mathbf{De}:y_3$ .

In  $s$ -domain, by applying the rule of the transfer function in  $s$ -form, the null signals  $\mathbf{Ns}(s)$  can be expressed from the input variables  $\mathbf{u}_{\tilde{\mathbf{B}}}(s)$  of the DBG  $\tilde{\mathbf{B}}$ , which are specified in the equation (7) and that are; the input variables  $\mathbf{u}(s)$ , the imposed output variables  $\mathbf{y}(s)$ , the initial conditions  $\mathbf{z}_0(s)$  and the component faults  $\mathbf{f}^c(s)$ , following rational transfer matrix accordingly to the equation (8):

$$\mathbf{u}_{\tilde{\mathbf{B}}} = \{\mathbf{y}, \mathbf{u}, \mathbf{z}_0, \mathbf{f}^c\} \quad (7)$$

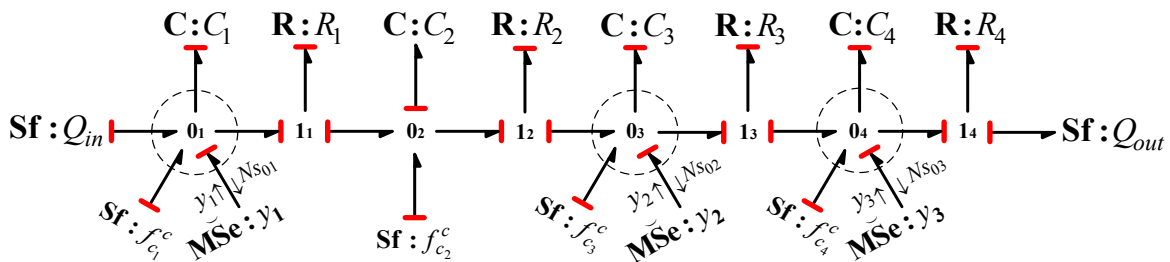

Figure 6. Diagnostic bond graph  $\tilde{\mathbf{B}}$ .

$$\mathbf{Ns}(s) = \frac{1}{\Delta(s)} [\Phi_{Ny}(s)\mathbf{y}(s) + \Phi_{Nu}(s)\mathbf{u}(s) + \Phi_{Nf^c}(s)\mathbf{f}^c(s) + \Phi_{Nz_0}(s)\mathbf{z}_0(s)] \quad (8)$$

Where  $\Phi_{Ny}(s)$ ,  $\Phi_{Nu}(s)$ ,  $\Phi_{Nf^c}(s)$  and  $\Phi_{Nz_0}(s)$  are polynomial matrices in the Laplace variable ( $s$ ) with appropriate dimensions and  $\Delta(s)$  is the characteristic polynomial of  $\tilde{\mathbf{B}}$  and it is a common denominator to all the elementary transfer functions.

To get the polynomial form of the ARR, the two sides of the equation (8) are multiplied by the common denominator  $\Delta(s)$ , and after that by neglecting the effects of initial conditions  $\mathbf{z}_0$ , because they are transient in time [5], it results then the equation (9):

$$\mathbf{ARRs}^p(s) = \Phi_{Ny}(s)\mathbf{y}(s) + \Phi_{Nu}(s)\mathbf{u}(s) + \Phi_{Nf^c}(s)\mathbf{f}^c(s) = 0 \quad (9)$$

Where  $\mathbf{ARRs}^p(s)$  are the primary ARRs generated from the original DBG  $\tilde{\mathbf{B}}$ , in the frequency domain [26]. Their numerical values are supposed in the neighborhood of zero due to measurement noises, parameter uncertainties and linearization errors.

Let the primary residuals be defined as follows:

$$\mathbf{r}^p(s) = \Phi_{Ny}(s)\mathbf{y}(s) + \Phi_{Nu}(s)\mathbf{u}(s) \quad (10)$$

Where, the part of the equation (10) involving known and measured variables is the residual computational form [28], thus it can be computed on line for fault detection and isolation. While, the part of the equation (9) involving the component faults is termed residual evaluation form [28].

**Corollary 1.** From the DBG  $\tilde{\mathbf{B}}$ , by using the rule of the transfer function in  $s$ -form, there is a need only to compute the denominator of the null signals  $\mathbf{Ns}$  to get ARRs in polynomial form.



**Corollary 2.** A component fault,  $f_{ci}^c$ ; with  $i = 1 \dots 4$ , can influence an ARR that is generated from a null signal  $Ns_j$ ; with  $j = 1 \dots 3$ , if its faults source  $\mathbf{Sf}$ :  $f_{ci}^c$  is causally linked through at least one causal path to the null signal  $Ns_j$ .

**Corollary 3.** Modeling the component faults as unknown inputs leads to direct separation between the computational and the evaluation forms.

In [26], a graphical algorithm entitled the influences approach is provided to generate symbolically the polynomial form of the ARRs, by computing the influence (or contribution) due to each input variable  $\sigma_j$  of  $\check{\mathbf{B}}$ ; with  $\sigma_j \in \mathbf{u}_{\check{\mathbf{B}}} \setminus \{\mathbf{z}_0\}$ , following the formulas (11-12):

$$ARR_i^p(s) = \sum_j \sum_k Inf_k \left( \sigma_j \xrightarrow{k} Ns_i \right) \quad (11)$$

$$Inf_k \left( \sigma_j \xrightarrow{k} Ns_i \right) = \tilde{G}_k(s) \Delta_k(s) \sigma_j(s) \quad (12)$$

Where  $ARR_i^p$  is the primary ARR generated from the  $i^{th}$  null signal  $Ns_i$ ,  $Inf_k$  is the elementary influence due to the  $k^{th}$  elementary causal path linking the  $j^{th}$  input  $\sigma_j$  to  $Ns_i$ ,  $\tilde{G}_k(s)$  is the numerator of the gain  $G_k(s)$  of the  $k^{th}$  causal path,  $\Delta_k(s)$  is the characteristic polynomial of the reduced DBG to the  $k^{th}$  causal path. The second sum is taken over all elementary causal paths and the first sum is taken over all the input variables,  $\sigma_j$ , of  $\check{\mathbf{B}}$ ; with  $\sigma_j \in \mathbf{u}_{\check{\mathbf{B}}} \setminus \{\mathbf{z}_0\}$ . For the calculation of all these terms, see the appendix.

By analyzing the residual computation form, the following corollary (4) can be made:

**Corollary 4.** A component fault is structurally detectable if, and only if, the component fault source is linked at least to one output detector.

The primary ARRs generated from the DBG  $\check{\mathbf{B}}$  of figure (6) are of number three; since there are three null signals  $\mathbf{Ns}$  due to three linearly independent detectors (see rule 3, in the appendix). Only their final expressions are given:

$$ARR_1^p = \left\{ - \left( s + \frac{1}{R_1 C_2} + \frac{1}{R_2 C_2} \right) Q_{in} + \left[ C_1 s \left( s + \frac{1}{R_1 C_2} + \frac{1}{R_2 C_2} \right) + \frac{1}{R_1} \left( s + \frac{1}{R_2 C_2} \right) \right] y_1 - \frac{1}{R_3 R_1 C_2} y_2 - \left( s + \frac{1}{R_1 C_2} + \frac{1}{R_2 C_2} \right) f_{c1}^c + \frac{1}{R_1 C_2} f_{c2}^c \right\} \quad (13)$$

$$ARR_2^p = \left\{ - \frac{1}{R_1 R_2 C_2} y_1 + \left[ \left( C_3 s + \frac{1}{R_3} \right) \left( s + \frac{1}{R_1 C_2} + \frac{1}{R_2 C_2} \right) + \frac{1}{R_2} \left( s + \frac{1}{R_2 C_2} \right) \right] y_2 - \frac{1}{R_3} \left( s + \frac{1}{R_1 C_2} + \frac{1}{R_2 C_2} \right) y_3 - \frac{1}{R_2 C_2} f_{c2}^c - \left( s + \frac{1}{R_1 C_2} + \frac{1}{R_2 C_2} \right) f_{c3}^c \right\} \quad (14)$$

$$ARR_3^p = \left\{ - \frac{1}{R_3} y_2 + \left( C_4 s + \frac{1}{R_3} + \frac{1}{R_4} \right) y_3 - f_{c4}^c \right\} \quad (15)$$

Clearly, the primary residuals  $r_1^p$ ,  $r_2^p$  and  $r_3^p$  are limited to parts of  $\mathbf{ARRs}^p$  of equations (13-15) involving the known input and measured output variables.

The Fault Signature Matrix (FSM) summarizing the sensitivity of the primary residuals to the component faults is illustrated by table (3); where the binary value 1 (resp. 0) indicates that the considered component fault affects (resp. doesn't affect) the considered primary residual.

Residuals \ Faults	Faults			
	$f_{c1}^c$	$f_{c2}^c$	$f_{c3}^c$	$f_{c4}^c$
$r_1^p$	1	1	0	0
$r_2^p$	0	1	1	0
$r_3^p$	0	0	0	1

**Table 3.** FSM of the primary residuals

The analysis of the FSM reveals that the effect of the component fault  $f_{c2}^c$  is not distinguishable from those of the faults  $f_{c1}^c$  and  $f_{c3}^c$ , since it affects both the residuals  $r_1^p$  and  $r_2^p$ . So, to overcome the insufficiency of the primary residuals to isolating all the component faults, the enhancement of fault isolation is required and it is ensured by the secondary residuals.

#### 4. SECONDARY RESIDUALS GENERATION

There is only one component fault,  $f_{c2}^c$ , concerned by the enhancement of isolation. Thus, only one secondary residual, which is structurally insensitive w.r.t. the considered fault, is sufficient to ensure this task.

It is the fault structural decoupling that ensures the insensitivity condition of the secondary residual in respect to the non-isolated fault, and its principle from bond graphs is clarified by the definition (1).

**Definition 1.** The principle of the fault structural decoupling is to perform causal transformations on the DBG  $\check{\mathbf{B}}$ , in order to annihilate any causal link, in the sense to interdict any causal path that may cause a transfer (or influence), between the component fault source to be decoupled and the null signals  $\mathbf{Ns}$  that furnish ARRs.

For showing the causal transformations needed by the structural decoupling in order to make the null signals of the DBG  $\check{\mathbf{B}}$  insensitive to the component fault source  $\mathbf{Sf}$ :  $f_{c2}^c$ , let the bicausal DBG devoted to generate the structurally decoupled secondary residual be denoted  $\check{\mathbf{B}}_{f_{c2}^c}^{sr}$  and it is written as the equation below:

$$\check{\mathbf{B}}_{f_{c2}^c}^{sr} = \check{\mathbf{B}}_{f_{c2}^c}^{\wedge}(z_2) \bowtie_{z_2} \check{\mathbf{B}}_{f_{c2}^c}^{\ast}(z_2) \quad (16)$$

Where  $\check{\mathbf{B}}_{f_{c2}^c}^{\wedge}(z_2)$  is the estimator bicausal DBG,  $\check{\mathbf{B}}_{f_{c2}^c}^{\ast}(z_2)$  is the decoupled bicausal DBG and  $(\bowtie_{z_2})$  is the binary causal joining operation that consists to attach, to each other, both the previous bicausal DBG. The subscript  $(\cdot, f_{c2}^c)$  means that: (1)  $\check{\mathbf{B}}_{f_{c2}^c}^{\ast}$  must be structurally decoupled from the component fault  $f_{c2}^c$ ; and (2)  $\check{\mathbf{B}}_{f_{c2}^c}^{\wedge}$  must furnish an

estimation of the unknown complementary state variable  $z_2$ ; whilst for a reason that will be argued in the subparagraph (4.1), the estimation must be structurally decoupled from the effect of  $f_{c2}^c$ . The subscript ( $\cdot_{z_2}$ ) means that the joining operation is made through the variable  $z_2$ .

The next subparagraphs outline the elements involved in the expression (16) of the bicausal DBG for the secondary residual generation,  $\tilde{\mathbf{B}}_{f_{c2}^c}^{sr}$ , and through them, the causal transformations needed to the faults structural decoupling are highlighted.

#### 4.1. Decoupled bicausal diagnostic bond graph

The decoupled bicausal DBG,  $\tilde{\mathbf{B}}_{f_{c2}^c}^{++}$ , which is structurally decoupled from the component fault,  $f_{c2}^c$ , in the sense of the definition (1), is established by operating the following causal transformations on the original DBG  $\tilde{\mathbf{B}}$  of figure (6):

1. The component fault source,  $\mathbf{Sf}: f_{c2}^c$ , to be decoupled must be substituted by the bicausal double detectors element  $\mathbf{DeDf}: f_{c2}^{c++}$ ;
2. The storage element in integral causality,  $C_2$ , which is the origin of the component fault  $f_{c2}^c$ , must be substituted by the bicausal double sources element  $\mathbf{SeSf}: ?$ , and;
3. To satisfy the causal half-strokes distribution, the bicausality is propagated from  $\mathbf{SeSf}: ?$  until reaching  $\mathbf{DeDf}: f_{c2}^{c++}$ .

At the end of the previous succession of causal transformations, it results the decoupled DBG  $\tilde{\mathbf{B}}_{f_{c2}^c}^{++}$  depicted by the figure (7).

The following properties show what happened in the SJS of  $\tilde{\mathbf{B}}_{f_{c2}^c}^{++}$ , as a result of component fault structural decoupling.

**Property 1.** The variables belonging to the decoupled bicausal DBG,  $\tilde{\mathbf{B}}_{f_{c2}^c}^{++}$ , have the subscript ( $\cdot^{++}$ ), and this does not change their meaning and values.

**Property 2.** The assigned value (?) to the bicausal double sources element,  $\mathbf{SeSf}: ?$ , means that, from now, the values of its effort and flow variables depend from an external environment to the decoupled bicausal DBG,  $\tilde{\mathbf{B}}_{f_{c2}^c}^{++}$ .

**Property 3.** The component fault,  $f_{c2}^{c++}$ , to be decoupled becomes an output variable to the SJS of  $\tilde{\mathbf{B}}_{f_{c2}^c}^{++}$ . Thus, all the null signals  $\mathbf{Ns}^{++}$  of  $\tilde{\mathbf{B}}_{f_{c2}^c}^{++}$  are structurally decoupled from the considered fault, in the sense of the definition (1).

**Property 4.** The unknown complementary state variable,  $z_2^{++}$ , becomes an input variable to the SJS of  $\tilde{\mathbf{B}}_{f_{c2}^c}^{++}$ . As a result, the null signals  $\mathbf{Ns}^{++}$  belonging to  $\tilde{\mathbf{B}}_{f_{c2}^c}^{++}$ , which are causally linked to  $z_2^{++}$  become dependent on its value.

From the property (3), the structurally decoupled ARRr from the effect of the component fault  $f_{c2}^c$  must be generated by calculating the null signals  $\mathbf{Ns}^{++}$  belonging to the decoupled DBG  $\tilde{\mathbf{B}}_{f_{c2}^c}^{++}$ . However, accordingly to the property (4), due to the unknown complementary state variable,  $z_2^{++}$ , it results that the null signals  $\mathbf{Ns}^{++}$  can't be calculated and they can't furnish ARRr. So, from now, the problem of unknown variables elimination is posed.

Here, the unknown variables elimination proceeds with the estimation of the unknown complementary state variable,  $z_2^{++}$ , by expressing it from known inputs,  $\mathbf{u}$ , and measured outputs,  $\mathbf{y}$ . But, due to the fact that  $z_2^{++}$  is an input variable to the SJS of the decoupled bicausal DBG  $\tilde{\mathbf{B}}_{f_{c2}^c}^{++}$ , thus the estimation must be structurally decoupled from the component fault  $f_{c2}^c$ , so that, its effect is not propagated through the estimated value of  $z_2^{++}$  to the null signal  $\mathbf{Ns}^{++}$  that furnish the structurally decoupled ARRr.

Let the estimated value of the unknown complementary state variable be denoted  $z_2^{\wedge}$  and the following subparagraph is concerned by its graphical calculation.

#### 4.2. Estimator bicausal diagnostic bond graph

The estimator bicausal DBG,  $\tilde{\mathbf{B}}_{f_{c2}^c}^{\wedge}(z_2)$ , which is devoted to furnish a structurally decoupled estimation of the unknown complementary state variable  $z_2^{++}$ , is established by performing the following causal transformations on the original DBG,  $\tilde{\mathbf{B}}$ , of the figure (6):

1. The storage element,  $C_2$ , which is the origin of the component fault to be decoupled  $f_{c2}^c$ , is substituted by the bicausal double detectors element  $\mathbf{DeDf}: !$ ;

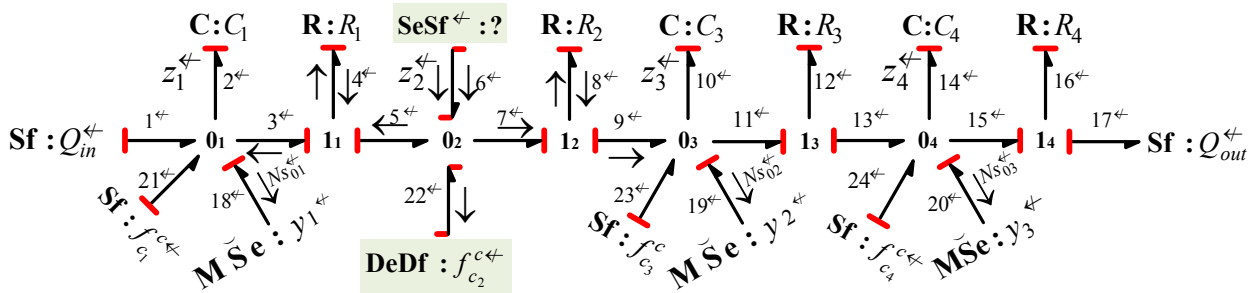

Figure 7. Decoupled bicausal DBG  $\tilde{\mathbf{B}}_{f_{c2}^c}^{++}$  from the component fault  $f_{c2}^c$ .

2. Arbitrary, choosing one of the two following imposed output sources,  $\mathbf{M}\check{\mathbf{S}}\mathbf{e}: y$  or  $\mathbf{M}\check{\mathbf{S}}\mathbf{e}: y_2$ , which are causally linked to the complementary state variable  $z_2$ , and substituting it by the bicausal double sources element,  $\mathbf{M}\check{\mathbf{S}}\mathbf{e}\mathbf{S}\mathbf{f}: y_1^\wedge$  or  $\mathbf{M}\check{\mathbf{S}}\mathbf{e}\mathbf{S}\mathbf{f}: y_2^\wedge$ . Let's choose the first one;
3. To satisfy the causal half-strokes distribution, the bicausality is propagated from  $\mathbf{M}\check{\mathbf{S}}\mathbf{e}\mathbf{S}\mathbf{f}: y_1^\wedge$  until reaching  $\mathbf{DeDf}: !$ .

In the end, of the previous succession of causal transformations, the estimator bicausal DBG,  $\check{\mathbf{B}}_{f_{c_2}^c}^\wedge(z_2)$ , is established and it is depicted in the figure (8).

The following properties show what happened in the SJS of  $\check{\mathbf{B}}_{f_{c_2}^c}^\wedge(z_2)$ , as a result of the structurally decoupled estimation of the unknown complementary state variable.

**Property 5.** The variables belonging to the estimator bicausal DBG,  $\check{\mathbf{B}}_{f_{c_2}^c}^\wedge(z_2)$ , have the subscript ( $^\wedge$ ), and this does not change their meaning and their values.

**Property 6.** The assigned value (!) to the bicausal double detectors element,  $\mathbf{DeDf}: !$ , means that the values of its effort and flow variables depend from the internal environment of the estimator bicausal DBG  $\check{\mathbf{B}}_{f_{c_2}^c}^\wedge(z_2)$ .

**Property 7.** The estimated value of the unknown complementary state variable,  $z_2^\wedge$ , is an output variable to the SJS of  $\check{\mathbf{B}}_{f_{c_2}^c}^\wedge(z_2)$ .

**Property 8.** The estimated value of the unknown complementary state variable,  $z_2^\wedge$ , is not causally linked to the component fault,  $f_{c_2}^{c^\wedge}$ , meaning that the estimation is structurally decoupled from the considered fault.

From the property (8), the alone condition on the estimation is hold. Indeed, when the estimation is structurally decoupled from the component fault in interest, this implies that the estimation error is consequently structurally decoupled from the same fault.

**Property 9.** There is no null signal at the  $0_1$ -junction of the estimator bicausal DBG  $\check{\mathbf{B}}_{f_{c_2}^c}^\wedge(z_2)$ .

From the property (9), the remark (4) is deduced.

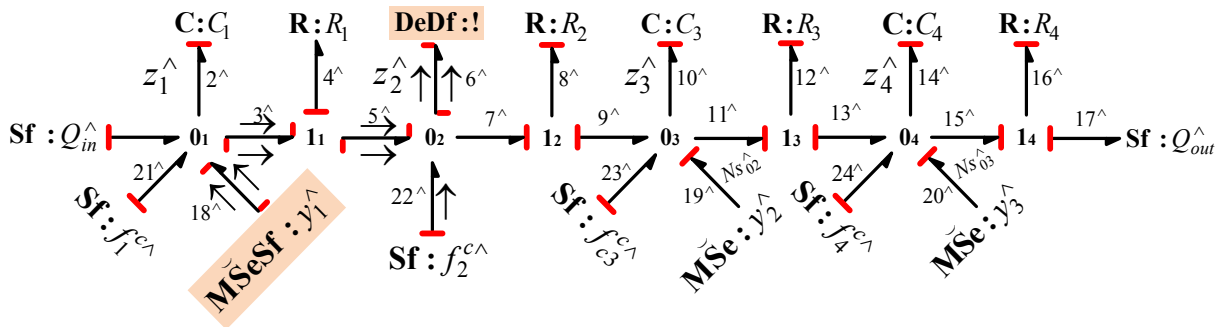

Figure 8. Estimator bicausal DBG  $\check{\mathbf{B}}_{f_{c_2}^c}^\wedge(z_2)$  for the structurally decoupled estimation

**Remark 4.** It is possible to say that the null signal  $Ns_{01}^\wedge$  belonging to the estimator bicausal DBG,  $\check{\mathbf{B}}_{f_{c_2}^c}^\wedge(z_2)$ , is used to furnish the estimated value of the unknown complementary state variable,  $z_2^\wedge$ .

At this stage, there is one fundamental result of the fault structural decoupling from bond graphs that must be shown. For this aim, let us recall the following ideas, in the order:

1. Remark (3) states that the output detector  $\mathbf{De}: y_1^\wedge$  is used to construct the null signal  $Ns_{01}^\wedge$ ;
2. Remark (4) states that the null signal  $Ns_{01}^\wedge$  provides the estimated value  $z_2^\wedge$ ;
3. From the properties (1) and (5), it is possible to state that  $z_2^\wedge$  is numerically equivalent  $z_2^{c^\wedge}$ ;
4. In the end, the property (4) states that  $z_2^{c^\wedge}$  is used for the structural decoupling of the fault  $f_{c_2}^{c^\wedge}$ .

By relating the previous ideas, it is possible to conclude that, indeed, it is the output detector  $\mathbf{De}: y_1^\wedge$ , which was used for the structural decoupling of the fault in interest.

From what has been said, the corollary (5) points out the first fundamental result of the fault structural decoupling from bond graphs.

**Corollary 5.** One output detector is needed to the structural decoupling of one additive component fault (or unknown input).

Corollary (5) agrees with one of the fundamental result in additive faults (or unknown inputs) decoupling from analytical approaches [8, 11].

**Remark 5.** It should be noted that the estimation procedure does not extend to numerically calculate the estimated value of the unknown complementary state variable,  $z_2^\wedge$ .

**Corollary 6.** The construction of the estimator bicausal DBG requires at least one causal path linking the complementary state variable to be estimated to an output detector. And, the state structural observability is a strong structural condition to ensure this property, since it necessitates causal link between the complementary state variables and the output detectors.

For state structural observability checking, see [23, 27, 30].



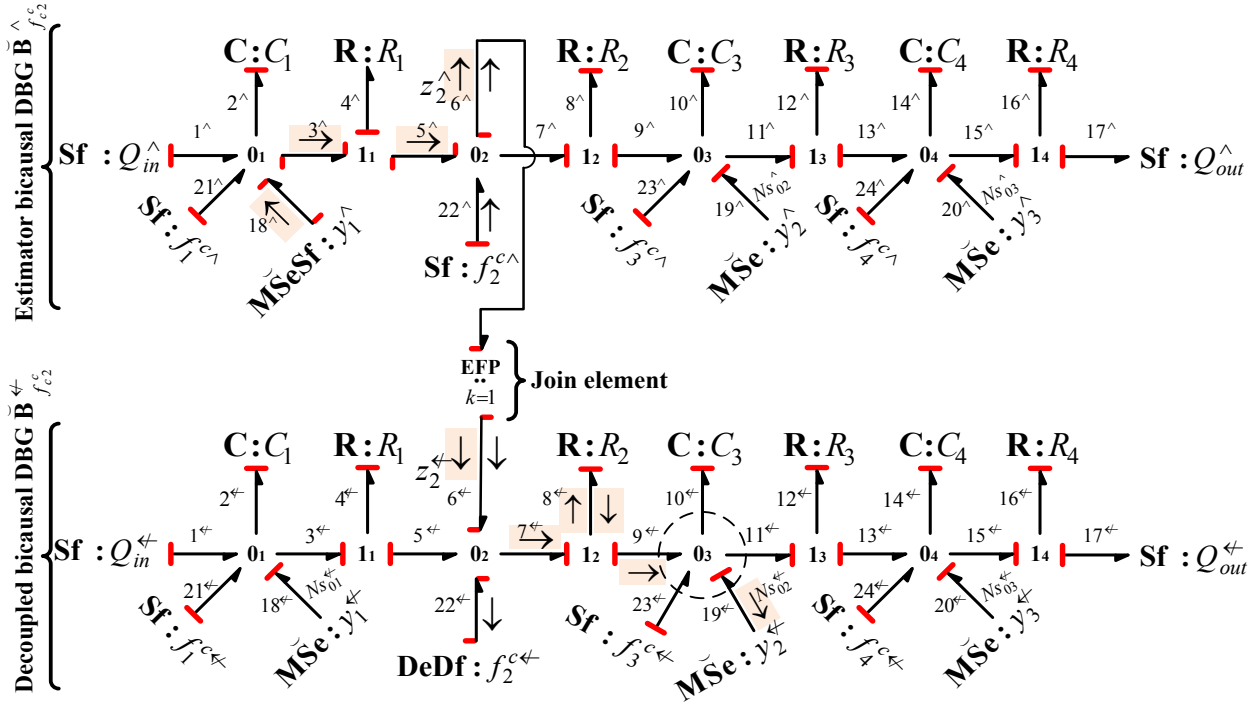

Figure 9. Bicausal DBG  $\tilde{\mathbf{B}}_{f_{c_2}^{SR}}$  for secondary residual generation.

#### 4.3. SECONDARY RESIDUALS GENERATION

The bicausal DBG for the secondary residual generation  $\tilde{\mathbf{B}}_{f_{c_2}^{SR}}$  is depicted by figure (9), where at the top, it is the estimator bicausal DBG  $\tilde{\mathbf{B}}_{f_{c_2}^{\wedge}}(z_2)$ , and at the bottom, it is the decoupled bicausal DBG  $\tilde{\mathbf{B}}_{f_{c_2}^{\leftarrow}}$  and both they are joined by the Effort and Flow Propagator (EFP) element with gain  $k = 1$ .

The EFP element is the bond graph realization of the binary causal joining operation and it is defined below:

**Definition 2.** An Effort and Flow Propagator element, noted EFP, is shown by figure (10). It is a two port and bicausal element, it has two inputs variables at its inward bond, two output variables at its outward bond and its gain is  $k$ . Its constitutive law is:

$$\text{EFP: } \begin{cases} e^{\leftarrow} = ke^{\wedge} \\ f^{\leftarrow} = kf^{\wedge} \end{cases} \quad (17)$$

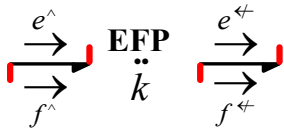

Figure 10. Effort & Flow Propagator (or join) element.

The EFB element is unidirectional; so it doesn't account for the feedback effect. Also, it is termed join element; this name is taken from the structural approach of ARR generation based on relational algebra [21], whose the joining relational operator is the fundamental tool.

Indeed, the secondary residual, denoted  $r_1^s$ , is the computational part of the secondary analytical redundancy relation, denoted  $ARR_1^s$ , which must be generated from the null signal  $Ns_{02}^{\leftarrow}$ , but not from the null signal  $Ns_{01}^{\leftarrow}$ . This last one doesn't contain any term and it furnishes precisely 0; its terms reconcile with each other and they vanish all; because accordingly to remark (4), the null signal  $Ns_{01}^{\leftarrow}$  belonging to  $\tilde{\mathbf{B}}_{f_{c_2}^{\wedge}}(z_2)$  is used to furnish the estimated value of the unknown complementary state variable,  $z_2^{\wedge}$ .

Here also, the secondary analytical redundancy relation,  $ARR_1^s$ , is generated by the influences approach applied to the null signal  $Ns_{02}^{\leftarrow}$ . Consequently, the causal analysis of  $\tilde{\mathbf{B}}_{f_{c_2}^{SR}}$  reveals six input variables causally linked to the null signal  $Ns_{02}^{\leftarrow}$ , that are:

$$\mathbf{u}_{B^{sr}} = \{ \text{Sf: } Q_{in}^{\wedge}; \text{M}\check{\text{S}}\text{eSf: } y_1^{\wedge}; \text{Sf: } f_{c_1}^{\wedge}; \text{M}\check{\text{S}}\text{e: } y_2^{\leftarrow}; \text{M}\check{\text{S}}\text{e: } y_3^{\leftarrow}; \text{Sf: } f_{c_3}^{\leftarrow} \} \quad (18)$$

The first three input variables belong to  $\tilde{\mathbf{B}}_{f_{c_2}^{\wedge}}$ , but the last three input variables belong to  $\tilde{\mathbf{B}}_{f_{c_2}^{\leftarrow}}$ .

**Remark 6.** Neither the component fault source  $\text{Sf: } f_{c_2}^{\wedge}$ , nor the component fault source  $\text{Sf: } f_{c_2}^{\leftarrow}$ , appear in the set  $\mathbf{u}_{B^{sr}}$  of the input variables causally linked to the null signal  $Ns_{02}^{\leftarrow}$ . So, they have no influence on  $Ns_{02}^{\leftarrow}$ .

From the remark (6), one has to agree the annihilation of the influence of the component fault  $f_{c_2}^{\leftarrow}$  on the null signal  $Ns_{02}^{\leftarrow}$ ; which furnishes in turn an insensitive secondary residual w.r.t. the same fault.

Let us show how to calculate the influence due to the input variable  $\mathbf{M\check{S}eSf}: y_1^\wedge$ . In effect, there are two elementary causal paths from this input variable to the null signal  $NS_{02}^\leftarrow$ , which are respectively determined by the equations (19) and (20), as successions of variables and edges and where each edge is augmented by its causal gain.

$$\begin{aligned} (\mathbf{M\check{S}eSf}: y_1^\wedge \xrightarrow{1^{st}} NS_{02}^\leftarrow) &= y_1^\wedge \xrightarrow{+1} e_{18}^\wedge \xrightarrow{+1} e_2^\wedge \\ \xrightarrow{C_1 s} f_2^\wedge \xrightarrow{-1} f_3^\wedge \xrightarrow{+1} f_4^\wedge \xrightarrow{R_1} e_4^\wedge \xrightarrow{-1} e_5^\wedge \xrightarrow{+1} e_6^\wedge \xrightarrow{+1} \mathbf{EFP} &= 1 \quad (19) \\ \xrightarrow{+1} e_6^\leftarrow \xrightarrow{+1} e_7^\leftarrow \xrightarrow{+1} e_8^\leftarrow \xrightarrow{\frac{1}{R_2}} f_8^\leftarrow \xrightarrow{+1} f_9^\leftarrow \xrightarrow{-1} NS_{02}^\leftarrow \end{aligned}$$

$$\begin{aligned} (\mathbf{M\check{S}eSf}: y_1^\wedge \xrightarrow{2^{nd}} NS_{02}^\leftarrow) &= y_1^\wedge \xrightarrow{+1} e_{18}^\wedge \xrightarrow{+1} e_3^\wedge \\ \xrightarrow{+1} e_5^\wedge \xrightarrow{+1} e_6^\wedge \xrightarrow{+1} \mathbf{EFP} &= 1 \xrightarrow{+1} e_6^\leftarrow \quad (20) \\ \xrightarrow{+1} e_7^\leftarrow \xrightarrow{+1} e_8^\leftarrow \xrightarrow{\frac{1}{R_2}} f_8^\leftarrow \xrightarrow{+1} f_9^\leftarrow \xrightarrow{-1} NS_{02}^\leftarrow \end{aligned}$$

The elementary influence due to the first elementary causal path is calculated as follows:

$$Inf_1^s \left( y_1^\wedge \xrightarrow{1^{st}} NS_{02}^\leftarrow \right) = \tilde{G}_1(s) \Delta_1(s) y_1^\wedge(s) \quad (21)$$

Where:

- $\tilde{G}_1(s)$ : is the part that does not contain integrators in the first causal path gain,  $G_1(s)$ . Since, the causal path doesn't travers any storage element in integral causality, then  $\tilde{G}_1(s)$  is identical to  $G_1(s)$  and it is to  $-\frac{R_1}{R_2} C_1 s$ ;
- $\Delta_1(s)$ : is the characteristic polynomial of the reduced bicausal DBG; which is obtained by supressing the first elementary causal path from  $\check{\mathbf{B}}_{f_{c_2}}^{SR}$ , and it is equal to 1; because the reduced bicausal DBG (not shown) doesn't contain any storage element in integral causality;

Accordingly to the equation (21), the elementary influence due to the first elementary causal path is:

$$Inf_1^s \left( \mathbf{M\check{S}eSf}: y_1^\wedge \xrightarrow{1^{st}} NS_{02}^\leftarrow \right) = -\frac{R_1}{R_2} C_1 s y_1^\wedge(s) \quad (22)$$

Following the same steps of symbolic calculus, the elementary influence due to the second elementary causal path is obtained and it is given below:

$$Inf_1^s \left( \mathbf{M\check{S}eSf}: y_1^\wedge \xrightarrow{2^{nd}} NS_{02}^\leftarrow \right) = -\frac{1}{R_2} y_1^\wedge(s) \quad (23)$$

In the last step, by total summing the influences due to all the input variables  $\mathbf{u}_{Bsr}$  of  $\check{\mathbf{B}}_{f_{c_2}}^{SR}$  and after deleting the subscripts, ( $\wedge$ ) and ( $\leftarrow$ ), it results the final expression in the polynomial form of the  $ARR_1^s$  and it is given hereafter:

$$ARR_1^s: \left\{ -\frac{R_1}{R_2} Q_{in} - \left( \frac{R_1}{R_2} C_1 s + \frac{1}{R_2} \right) y_1 + \left( C_3 s + \frac{1}{R_2} + \frac{1}{R_3} \right) y_2 - \frac{1}{R_3} y_3 - \frac{R_1}{R_2} f_{c_1}^c - f_{c_3}^c \right. \quad (24)$$

Clearly, the secondary residual,  $r_1^s$ , is reduced to the part of the  $ARR_1^s$ , which involves only known input and measured output variables.

From the previous development, it has been stated that

1. The decoupled secondary residual  $r_1^s$  is generated from the null signal  $NS_{02}^\leftarrow$ , and;
2. The null signal  $NS_{02}^\leftarrow$  is due the output detector  $\mathbf{De}$ :  $y_2$ ,

Then it is possible to conclude that the output detector  $\mathbf{De}$ :  $y_2$ , itself, which was used for generating the decoupled secondary residual.

At this stage, from what has been said and by taking into account the corollary (5), then the second fundamental result of the fault structural decoupling from bond graphs is pointed out by the corollary (7).

**Corollary 7.** To generate a secondary residual that is structurally decoupled from one additive component fault (or unknown input), two output detectors are necessary. The first one is used to structurally decoupling the fault (or unknown input), and the second one is used to generate the decoupled secondary residual itself.

The corollary (7) agrees well with the principle of additive faults isolation (or unknown inputs robustness) by means of perfect unknown inputs decoupling from the analytical approaches [8, 11].

Figure (11) shows, by means of the secondary residual, another benefit of the influences approach for computer implementation of the residuals. It is the parallel realisation of the computational form, where the elementary influences due to the different elementary causal paths are taken such that as they are generated and summated to get the computer implemented form of the secondary residual; which means that there are no additional algebraic manipulations to be performed.

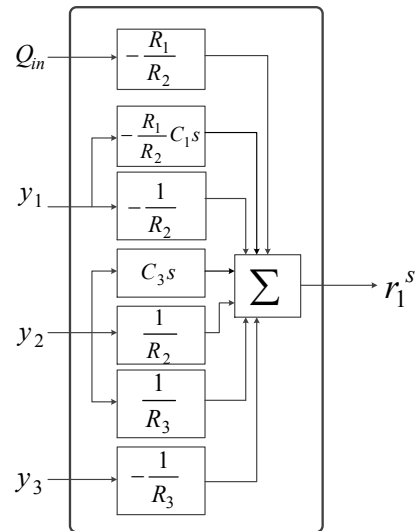

Figure 11. Parallel realization of the secondary residual.

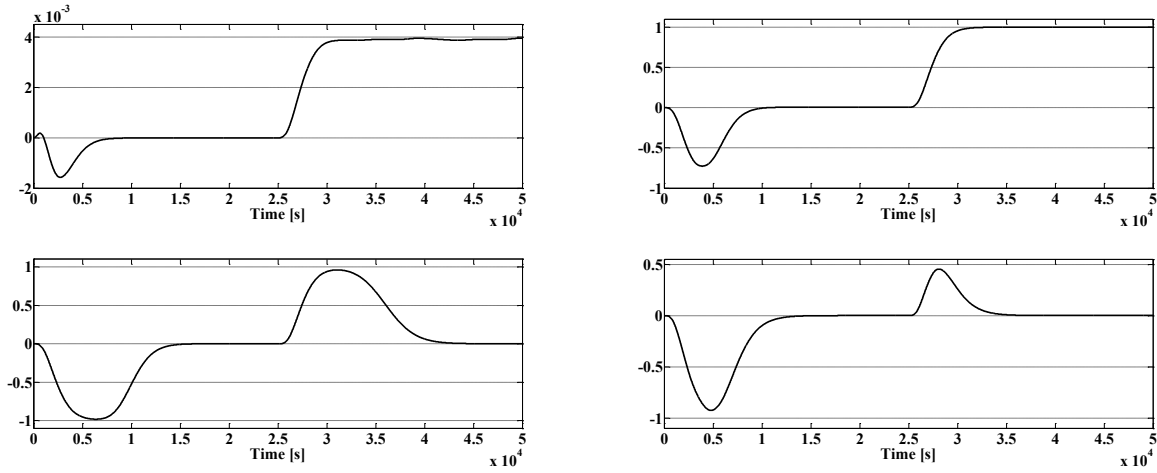

Figure 12. Trajectories of the residuals, in order,  $r_1^p$ ,  $r_2^p$ ,  $r_3^p$  and  $r_1^s$ , in the presence of the component fault  $f_{c2}^c$ .

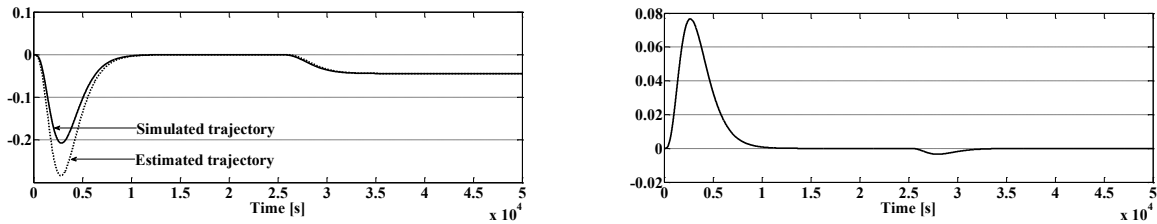

Figure 13. a) Simulated and estimated trajectories of  $z_2$ , b) Estimation error.

## 5. SIMULATION RESULTS

The simulation runs the residuals that are normalized in the interval  $[-1; 1]$ . To handle measurement noises and input fluctuations, the residuals are followed by a State Variable Filter (SVF); with the cutoff frequency  $\omega_c = 2\pi/T_r$ , and where  $T_r = 4000s$  is the time response of the four hydraulic tanks system. The simulation is achieved with Matlab/Simulink software, version 7.10.0 (R2010a).

The validity of the proposed fault structural decoupling algorithm is tested through an abrupt structural fault at the junction ( $0_2$ ); as a leakage in the tank 2, with magnitude 3% of  $Q_{in}$  and it is introduced at time  $t = 25000s$ .

The simulation results validate the developed theory. In effect, the figure (12) shows that after a transient behavior due to initial conditions, all the residuals tend to zero, indicating that the linearization has no effect. And, from the apparition of the considered component fault, the following observations can be deduced:

- The residuals  $r_1^p$  and  $r_2^p$  persist different from zero; since they are both structurally sensitive to the component fault  $f_{c2}^c$ .
- The residual  $r_3^p$  exhibits a transient behavior and it returns to its initial normal behavior; because it is structurally insensitive to the fault  $f_{c2}^c$ , and;
- The secondary residual,  $r_1^s$ , returns to its initial and normal behavior after a short transient; because it is made structurally insensitive to the considered

component fault by structural decoupling. This confirms well the success of fault structural decoupling.

The figure (13.a) illustrates both the structurally decoupled estimation and the simulated trajectories of the unknown complementary state variable,  $z_2$ . While, the figure (13.b) shows the estimation error that is structurally decoupled from the considered component faults; because it is zero in steady state.

## 6. CONCLUSION

The proposed new structural algorithm of ARRs design, from linear and linearized bond graphs, in the frequency domain, for component FDI system, has achieved its objectives; so that it presents the following characteristics:

From FDI issues point of view: **(1)** it's structural; so it can be used at the design stage; **(2)** it is iterative; so it treats component by component; **(3)** it doesn't necessitate unknown variables elimination for the primary residuals generation, even if, for the secondary residuals it does. Fortunately, the estimation doesn't extend to numerical calculation; **(4)** it uses structural fault decoupling to carry out the rule of structured residuals for the aim of component faults isolation enhancement. Here, the fault structural decoupling, itself, requires structurally decoupled estimation from the component fault in interest; and **(5)** the fault structural decoupling is robust w.r.t. parameters uncertainties; since it is based on simple causality breaking rather than polynomial, rational or numerical matrices annihilator.

From implementation issues point of view: **(6)** the residuals generation is homogenized by using the rule of the transfer function in  $s$ -form; and **(7)** the generated residuals can be implemented, such that, in parallel scheme without any additional algebraic manipulations.

Due to the advantages provided by the new structural algorithm for component fault detection and isolation, from one hand, and due to its automated calculus, from other hand, it is possible to conclude that the efficiency of the proposed structural approach is comparable to that of the analytical ones.

## REFERENCES

- Benmoussa, S., 2013. 'Bond graph approach for algebraic component fault detection and isolation.' PhD. thesis, University of Lille, France.
- Borutzky, W. 2010. *Bond Graph Methodology –Development and Analysis of Multidisciplinary dynamic system models*. Springer-Verlag London.
- Brown, F.T. 2007. *Engineering System Dynamics, a Unified Graph-Centered Approach*, 2nd Ed., Chapter 6. CRC Press, Taylor and Francis Group, FL. USA.
- Chen, J., and R.J. Patton. 1999. *Robust Model Based Fault Diagnosis for Dynamic Systems*. Chapter 3. Kluwer Academic Publishers, Boston USA.
- Ding S.X. 2012. *Model Based Fault Diagnosis Techniques: Design Schemes, Algorithms and Tools*. Chapter 13. Springer-Verlag, London.
- Düstegör, D., Frisk, E., M., Krysander, V., Cocquempot and M., Staroswiecki, 2006. "Structural analysis of fault isolability in the DAMADICS benchmark. In Control Engineering Practice. Vol. 14, no.6, pp. 597-608.
- Frisk, E., D., Düstegör, M., Krysander and V., Cocquempot, 2003. "Improving fault isolability proprieties by structural analysis of faulty behavior models: Application to the damadics benchmark problem." In Proc. of IFAC Safeprocess 03, 1107-1112, Washington, USA.
- Frank, P. M.; 2002. "Handling modelling uncertainty in fault detection and isolation systems." In Journal of Control Engineering and Applied Informatics, Vol. 4, no: 4, pp. 29-46.
- Gahlouz, I., 2014. 'Unknown inputs observers for component faults estimation: Bond graph approach.' PhD. thesis, University of Lille, France.
- Gawthrop, P.J., 1995. "Bicausal bond graph." In F.E. Cellier and J.J. Granda, editors, *Proc. of ICBGM'95*. Vol.27(1) of simulation series, SCS Publishing, pp. 83-88, Las Vegas, Nevada, USA, January 15-18.
- Gertler, J.J. (1988). *Fault Detection and Diagnosis in Engineering Systems*. Marcel Dekker, USA.
- Ge, W., and C., Fang, 1988. 'Detection of faulty components via robust observation.' *Int. J. Contr.*, Vol. (47), pp. 581-599.
- Karnopp, D.C., D.L., Margolis and R.C., Rosenberg. 1990. *System dynamics: A unified approach*. New York, Wiley, USA.
- Korbicz, J., J.M., Koscielny, Z., Kowalczyk, and W., Cholewa. 2004. *Fault diagnosis*. Berlin, Springer-Verlag.
- Lamb, J.D., G.H., Asher and D.R. Woodall, 1993, 'Causal loops and Mason's rule for bond graphs.' In J.J. Granda and F.E. Cellier, editors, *Proc. of ICBGM'93*, SCS Publishing, Vol. 25, no: 2 of simulation series, pp. 67-72, January 17-20, La Jolla, California.
- Medjaher, K., A.K., Samantaray, B., Ould Bouamama, M., Staroswiecki and G., Dauphin-Tanguy, 2005. "Diagnostic bond graphs for direct residual evaluation." In F.E. Cellier and J.J. Granda, editors, *Proc. of ICBGM'05*, SCS Publishing, Vol. 37, no:1 of simulation series, pp. 307-312, New Orleans, Louisiana, USA, January 23-27.
- Merzouki, R., A.K. Samantaray, P.M. Pathak and B. Ould Bouamama, 2013. *Intelligent Mechatronic Systems: Modeling, Control and Diagnosis*. Springer-Verlag, London.
- Mouhri, A., A., Rahmani, and G., Dauphin-Tanguy, 1999. "Symbolic determination of generalized state equation for singular system modeled by bond graph." In Proc. CSCC'99, Athens- Greece, 229 –234.
- Ould Bouamama, B., A.K., Samantaray, M., Staroswiecki and G., Dauphin-Tanguy, 2003. "Derivation of constraint relations from bond graph models for fault detection and isolation." In J.J. Granda and F.E. Cellier, editors, *Proc. of ICBGM'03*. 35, no. 2, of simulation series, SCS Publishing, 104-109, New Orleans, USA, January 19-23.
- Pichardo-Almarza, C., A., Rahmani, G., Dauphin-Tanguy and M., Delgado, 2003. "Bond Graph Approach to Build Reduced Order Observers in Linear Time Invariant Systems." European Control Conference (ECC), IEEE Publishing, 457–462, September 1-4.
- Ploix, S., A.A., Yassine and J.M. Flaus, 2010. "A new efficient and flexible algorithm for the design of testable subsystems." *Int. J. Appl. Math. Comput. Sci*, 20, no. 1, 175-190.
- Rahmani, A., 1990. "Bond graph approach to structural analysis of linear systems." PhD. thesis, University of Lille, France.
- Rimaux, S., 1995. "Study of structural properties of specific classes of physical nonlinear systems modeled by bond graph." PhD thesis, University of Lille. France.
- Samantaray, A.K., and B., Ould Bouamama, 2008. *Model based supervision: A bond graph approach*. Springer-Verlag, London, 2008.
- Sia, k., A., Naamane and N.K. M'Sirdi, 2012. "A new structural approach for ARRs generation from linear & linearized bond graphs: Approach based on state structural observability." In J.J. Granda and F.E. Cellier, editors, *Proc. of ICBGM'12*, 44, no. 13 of simulation series, SCS Publishing, 130-142, Genoa, Italy, July 8-11.
- Sia, k., A., Naamane and N.K., M'Sirdi, 2011. "A new structural approach for ARRs generation from linear & linearized bond graphs: Approach based on the transfer function." IEEE Conf. on Comm. Comput. and Cont. Appli. CCCA'11. Tunisia.
- Sia, k., A., Naamane and N.K., M'Sirdi, 2012. "Structural state observability & controllability of linear and linearized bond graphs: A Simple graph tools based reasoning approach." IEEE Conf. on Comm. Comput. and Cont. Appli. CCCA'12. December 6-8, Marseille, France.
- Staroswiecki, M., and G., Comtet-Vega, 2001. "Analytical redundancy relations for fault detection and isolation in algebraic dynamic systems." *Automatica*, 37, no.5, 687–699.

29. Staroswiecki, M. 2006. ‘Structural analysis.’ In M. Blanke, M. Kinnaert, J. Lunze and M. Staroswiecki. *Diagnosis and Fault-Tolerant Control*. Chapter 5. 2<sup>nd</sup> eds. Springer-Verlag, Berlin Heidelberg.
30. Sueur, C., and G., Dauphin-Tanguy, 1991. “Bond graph approach for structural analysis of MIMO linear systems.” *Journal of the Franklin Institute*, 328, no. 1, 55–70.
31. Tarasov, E. 2015. ‘Unknown inputs estimation for control and diagnosis: Bond graph approach.’ PhD. thesis, University of Lille, France.
32. Thoma, J.U. 1990. *Simulation by bond graph: Introduction to graphical method*. Chapter 6. Springer-Verlag Berlin Heidelberg.

## Appendix

The rule of the transfer function in  $s$ -form [22] uses the concept of causal cycle families, in order to write the numerator and the denominator as polynomials in the integer power of the Laplace variable ( $s$ ). It is then an alternative to the graphical rule furnished in [3]; which uses the Mason’s loop rule to get the transfer function, but in  $s^{-1}$ -form. This last one writes the nominator and the denominator as sum of terms in the integer power of ( $s^{-1}$ ), which needs consequently extra algebraic manipulations to get the transfer function in its classical  $s$ -form.

The following given rule is a general one, since it handles both the regular and the generalized bond graphs. It should be noted that the generalized bond graphs contain storage elements (**I** and **C**) in derivative causality. This new rule is similar to that given in [18], but it rewrites the coefficients in a different manner.

### Rule 1. Transfer function in $s$ -form

Let **B** be a linear (or linearized) bond graph in preferred integral causality, it may be regular or generalized and it has  $n$  storage elements in integral causality; i.e. its order is  $n$ . It is supposed fitted with the two sets of output detectors, **D**, and power sources, **S**, that are defined as follows:

$$\{\mathcal{D} = \{\mathbf{D}_i: y_i, i = 1 \dots m \mid \mathbf{D} \equiv (\mathbf{De} \text{ or } \mathbf{Df})\} \quad (25)$$

$$\{\mathcal{S} = \{\mathbf{S}_j: u_j, i = 1 \dots p \mid \mathbf{S} \equiv (\mathbf{Se} \text{ or } \mathbf{Sf})\} \quad (26)$$

Where **D** (resp. **S**) stands for an output detector (resp. power source) with unspecified causality, **De** (resp. **Se**) stands for an effort output detector (resp. power source), **Df** (resp. **Sf**) stands for a flow output detector (resp. power source),  $y_i$  (resp.  $u_i$ ) is the output (resp. input) variable measured (resp. supplied) by the output detector **D**<sub>*i*</sub> (resp. power source **S**<sub>*i*</sub>) and ( $\equiv$ ) stands for “equivalent to”.

Then, the output variable  $y_i$ , with  $i = 1 \dots m$ , can be expressed from the input variables  $u_j$ , with  $j = 1 \dots p$ , following the formula hereafter:

$$y_i = \sum_j^p \sum_k^\infty \text{Inf} \left( u_j \xrightarrow{k} y_i \right) \quad (27)$$

Where, the elementary influence,  $\text{Inf} \left( u_j \xrightarrow{k} y_i \right)$ , due to the  $k^{\text{th}}$  elementary causal path,  $\left( u_j \xrightarrow{k} y_i \right)$ , is:

$$\text{Inf} \left( u_j \xrightarrow{k} y_i \right) = \frac{\tilde{G}_k(s) \Delta_k(s)}{\Delta(s)} \quad (28)$$

With  $\tilde{G}_k(s)$  is the numerator of the gain  $G_k(s)$  of the elementary causal path that is determined as follows:

$$G_k(s) = \frac{T s^\alpha}{s^\beta} \quad (29)$$

Where  $T$  is the constant term of the gain and  $\beta$  (resp.  $\alpha$ ) is the number of integrators (resp. derivatives) traversed by the causal path.

And  $\Delta(s)$  is the characteristic polynomial of the whole bond graph **B** and  $\Delta_k(s)$  is the characteristic polynomial of the reduced (or complementary) bond graph **B**<sub>*k*</sub>; it is obtained by suppressing the  $k^{\text{th}}$  elementary causal path.

### Rule 2. Characteristic polynomial of a bond graph model

The characteristic polynomial, of a linear (or linearized) bond graph model that may be regular or generalized, is given by the formula hereafter:

$$\Delta(s) = a_0 s^n + a_1 s^{(n-1)} + a_2 s^{(n-2)} + \dots + a_n \quad (30)$$

Where  $n$  is the order of the bond graph model,  $s$  is the symbolic Laplace variable. The coefficient  $a_0 \neq 0$  and the coefficients  $a_i$ ; with  $i = 1, 2, \dots, n$ , are given by the equation (31):

$$a_i = \sum_j (-1)^d \tilde{G}_j^{(i)}(s) \quad (31)$$

Where:

$i$  : is the order of the causal cycle family; with  $i = 1 \dots n$ . And  $i = \beta - \alpha$ ; with  $\beta$  (resp.  $\alpha$ ) is the number of integrators (resp. derivatives) traversed by the causal cycles (or loops) involved in the  $j^{\text{th}}$  causal cycle family.

$d$  : is the number of disjoint causal cycles (or loops) involved in the  $j^{\text{th}}$  causal cycle family.

$\tilde{G}_j^{(i)}$  : is the constant term of the gain  $G_j^{(i)}(s)$  of the  $j^{\text{th}}$  causal cycle family of order  $i$ .

The causal gain of the  $j^{\text{th}}$  causal cycle family of order  $i$  is:

$$G_j^{(i)}(s) = s^{-i} \prod_k^d \tilde{C}_k \quad (32)$$

Where  $\tilde{C}_k$  is the constant term of the gain of the  $k^{\text{th}}$  causal cycle (or loop) and the product is taken over all the disjoint causal cycles (or loops) involved in the causal cycle family of order  $i$ .



Particularly, the coefficient  $a_0$  is the graph (or Mason's) determinant of the bond graph model  $\mathbf{B}$ , and it is given by the equation (33):

$$a_0 = 1 - \sum_j B_j^0 + \sum_{j,k} B_j^0 B_k^0 - \sum_{j,k,l} B_j^0 B_k^0 B_l^0 + \dots \quad (33)$$

Where  $B_j^0$  is the constant term of the disjoint causal loops gain of order 0 taken one by one,  $B_j^0 B_k^0$  is the product of the constant terms of the gains of disjoint loops of order 0 taken two by two and  $B_j^0 B_k^0 B_l^0$  is the product of the constant terms of the gains of disjoint causal loops of order 0 taken three by three, and so on...

**Remark 7.** If there is no causal loop of order 0 in the linear (or linearized) bond graph, then the coefficient  $a_0$  is reduced to 1.

**Remark 8.** If in addition to the causal cycle family of order  $i$ , the linear (or linearized) bond graph model contains causal cycles (or loops) of order 0, then the causal cycle family is given by the equation (34).

$$G_j^{(i)}(s) = \Delta_0^{(i)} \times s^{-i} \prod_k^d \tilde{C}_k \quad (34)$$

Where  $\Delta_0^{(i)}$  is the product of the gains of disjoint causal cycles (or loops) of order zero.

In the end, in the general case where the general junction structure (GJS) of the linear (or linearized) bond graph model involves bond loops; the gain of the causal cycle family must be multiplied by the Mason's determinant of the GJS, see for this [15].

The rule 3 is dedicated to recognizing the linearly independent output detectors, directly from the bond graph model in integral causality, by simple causal manipulations. Its fundamental tools are the bicausality and the state-to-output causal paths concepts.

### Rule 3. Linear independency of output detectors

Let  $\mathbf{B}$  be a linear (or linearized) bond graph model, in preferred integral causality and it has  $n$  storage elements in integral causality; i.e. its order is  $n$ . It is supposed fitted by a set of output detectors  $\mathcal{D}$  that is defined by the equation (35):

$$\mathcal{D} = \{\mathbf{D}_i: y_i, i = 1 \dots m \text{ and } m \leq n \mid \mathbf{D} \equiv (\mathbf{De} \text{ or } \mathbf{Df})\} \quad (35)$$

Where  $\mathbf{D}$  stands for an output detector with unspecified causality,  $\mathbf{De}$  (resp.  $\mathbf{Df}$ ) stands for an effort (resp. flow) detector,  $y_i$  is the output variable measured by the output detector  $\mathbf{D}_i$  and  $(\equiv)$  stands for equivalent.

Then, the output detectors are linearly independent if, and only if, when they are substituted by bicausal double sources elements  $\mathbf{SeSf}: y_i$ ; with  $i = 1 \dots m$ , the following three properties hold simultaneously:

1. There exists  $m$  storage elements ( $\mathbf{I}$  and  $\mathbf{C}$ ) in integral causality that accept to be substituted by bicausal double detector elements  $\mathbf{DeDf}: !$ ;
2. The propagation of the bicausality, from  $\mathbf{SeSf}: y_i$  until reaching  $\mathbf{DeDf}: !$ , is satisfied, and;
3. The resulted bicausal bond graph is solvable.

The figures (14) and (15) show how operate the causal transformations to be performed to the output detectors and the storage elements ( $\mathbf{I}$  and  $\mathbf{C}$ ) to carry out the rule (2).

Indeed, the rule (3) point out the conditions that allow expressing the complementary state variables from the output variables. It should be noted that a quasi-similar graphical rule based on the bicausality is announced in [20] to check the invertible sub matrix of the observation matrix of the state space model, except that the solvability condition is not mentioned. Or, this condition is necessary to correctly performing numerical calculus.

**Remark 9.** If the number  $m$  of the output detectors is greater than the order  $n$  of the bond graph model, then the output detectors are linearly structurally dependent.

Also, there is a need to distinguish between the linearly independent output detectors from the linearly dependent ones. The following remark advises about this kind of output detectors and it is based on the violation of the conditions of the rule 2.

**Remark 10.** The output detectors, for which there are no state-to-output causal paths to propagate the bicausality half-strokes, they are said linearly dependents.

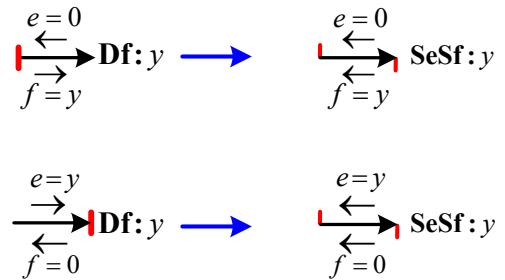

Figure 14. Substitution of output detectors by bicausal double sources elements

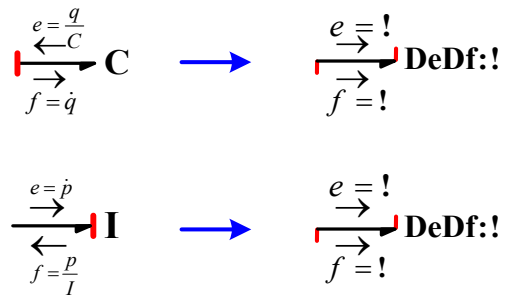

Figure 15. Substitution of storage ( $\mathbf{I}$  and  $\mathbf{C}$ ) elements by bicausal double detector elements

By applying the duality principle to the rule 3, it is possible to deduce the rule 4, which is dedicated to recognizing the linearly independent power sources. Its fundamental tools are the bicausality and the input-to-state causal paths concepts.

**Rule 4. Linear independency of power sources**

Let **B** be a linear (or linearized) bond graph model, in integral causality, and it has  $n$  storage elements in integral causality; i.e. its order is  $n$ . It is supposed fitted by a set  $\mathcal{S}$  of power sources that is defined by the equation (35):

$$\mathcal{S} = \{\mathbf{S}_i: u_i, i = 1 \dots p \text{ and } p \leq n \mid \mathbf{S}_i \equiv (\mathbf{Se} \text{ or } \mathbf{Sf})\} \quad (35)$$

Where **S** stands for a power source with unspecified causality, **Se** (resp. **Sf**) stands for an effort (resp. flow) power source,  $u_i$  is the input variable supplied by the power source  $\mathbf{S}_i$  and ( $\equiv$ ) stands for equivalent to.

Then, the power sources are linearly independent if, and only if, when they are substituted by bicausal double detectors elements **DeDf**:  $u_i$ ; with  $i = 1 \dots p$ , the following three properties hold simultaneously:

1. There exist  $p$  storage elements (**I** and **C**) in integral causality that accept to be substituted by bicausal double sources elements **SeSf**: ?;
2. The propagation of the bicausality, from **SeSf**: ? Until reaching **DeDf**:  $u_i$ , is satisfied, and;
3. The resulted bicausal bond graph is solvable.

The figures (16) and (17) show the causal transformations to be performed to the power sources and to the storage elements (**I** and **C**) to carry out the rule (4).

The remark (11) identifies a particular case for which the output detectors are structurally linearly dependent because of their number.

**Remark 11.** If the number  $p$  of the power sources is greater than the order  $n$  of the bond graph model, then the power sources are linearly structurally dependent.

There is a need to distinguish between the linearly independent power sources from the linearly dependent ones. The following remark advises this particular kind of power sources and it is based on the violation of the conditions of the rule 4.

**Remark 12.** The power sources, for which there are no input-to-state causal paths to propagate bicausality half-strokes, they are said structurally linearly dependent.

In the end, the following concepts intervene in the rule of the transfer function in s-form, they are recalled succinctly. The interested reader may find more detail in [2, 17, 24].

**Definition 3.** A causal path between two ports is an alternation of bonds and basic bond graph elements such that (i) all elements have a correct and complete causality,

and (ii) two bonds of the path have opposite causal stroke direction.

**Definition 4.** The causal path gain is the product of all the gains (or influence coefficients) of its edges. Where, the gain of each edge is equal to  $(-1)$  or  $(+1)$ , when respectively there is or not a change of bond orientations at the 0 (resp. 1) junction, by following the flow (resp. effort) variable, but, if a bond graph element is traversed; the gain is equal to the element transmittance expressed in symbolic Laplace operator ( $s$ ).

**Definition 5.** A causal loop is a closed causal path starts and ends at the same element. It can exist between two elements of **R**, **C**, or **I** type.

**Definition 6.** A causal cycle is a closed causal path that can contain more than two storage (**I**, **C**) elements (with any causality).

**Definition 7.** Two closed causal paths are disjoint if they have neither junctions nor bonds in common while following the same type of variable.

**Definition 8.** A causal cycle family is a set of disjoint causal cycles. The family is said to be of order  $i = \beta - \alpha$ , if it contains  $\beta$  (resp.  $\alpha$ ) storage elements (**I** and **C**) in integral (resp. derivative) causality.

The gains of causal loops and the causal cycles are calculated similarly as for the causal path.

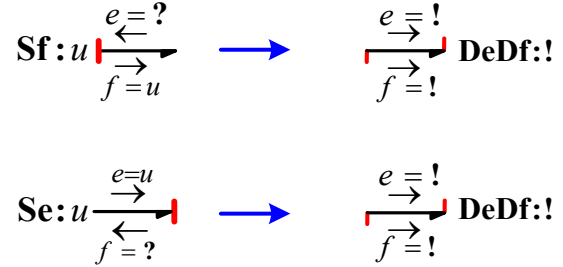

**Figure 16.** Substitution of power sources by bicausal double detectors elements.

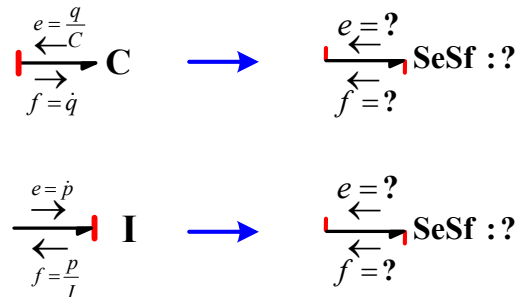

**Figure 17.** Substitution of storage (**I** and **C**) elements by bicausal double sources element.