



HAL
open science

Regular paper Review of Different MPPT techniques for a Photovoltaic Generation System

Ameni Kchaou, A Naamane, Y Koubaa, N. M'Sirdi

► To cite this version:

Ameni Kchaou, A Naamane, Y Koubaa, N. M'Sirdi. Regular paper Review of Different MPPT techniques for a Photovoltaic Generation System. *Journal of Automation & Systems Engineering*, 2017, 11, pp.195 - 207. hal-01967653

HAL Id: hal-01967653

<https://amu.hal.science/hal-01967653v1>

Submitted on 1 Jan 2019

HAL is a multi-disciplinary open access archive for the deposit and dissemination of scientific research documents, whether they are published or not. The documents may come from teaching and research institutions in France or abroad, or from public or private research centers.

L'archive ouverte pluridisciplinaire **HAL**, est destinée au dépôt et à la diffusion de documents scientifiques de niveau recherche, publiés ou non, émanant des établissements d'enseignement et de recherche français ou étrangers, des laboratoires publics ou privés.

Review of Different MPPT techniques for a Photovoltaic Generation System

Ameni Kchaou¹, A. Naamane¹, Y. Koubaa¹ and N. K. M'Sirdi²

¹Electrical Engineering Department, ENIS, Sfax, Tunisia

²Aix-Marseille University, France

Abstract- The Photovoltaic (PV) panel characteristic is nonlinear and depends on solar irradiation and temperature cell variation. Consequently, a Maximum Power Point Tracking (MPPT) algorithm is necessary to obtain the maximized produced energy from the PV. The main purpose of MPPT technique is to guarantee that the maximum power is produced. This allows to extract the maximum power instantaneously. This paper is aimed to study the performance of different MPPT techniques. These techniques are tested while the temperature was randomly varied. The simulation results are evaluated via Matlab-Simulink.

Keywords: Photovoltaic System, Maximum Power Point Tracking (MPPT).

NOMENCLATURE

A	ideality factor
G	solar irradiance (W/m ²)
G _n	reference irradiation (W/m ²)
I _d	saturation current (A)
I _{mpp}	maximum power point current (A)
I _{pv}	photovoltaic panel current (A)
I _{tr}	saturation current at T _r (A)
I _{sc}	Short circuit current (A)
I _{scr}	short-circuit current at reference condition (A)
k _b	Boltzmann's constant
k _i	short-circuit temperature coefficient
q	charge of an electron
T	cell temperature (K)
T _r	reference temperature (K)
V _{mpp}	maximum power point voltage (V)
V _{oc}	open circuit voltage (V)
V _{pv}	photovoltaic panel voltage (V)

1. INTRODUCTION

Nowadays, the stock of conventional sources (such as fossil energies and uranium reserves, etc.) are getting more and more limited. To bridge this gap, solar energy presents an alternative solution to produce the needed amount of electricity. Photovoltaic generation

systems have become an interesting solution. Thus, the demand of PV generation systems seems to be increased for both standalone and grid-connected modes of PV systems.

The non-linear feature of the I-V characteristic presents the major problem. In general, the I-V curve exhibits a unique point, called the Maximum Power Point (MPP), where the entire PV system generates its maximum output power. Maximum Power Point Tracking (MPPT) algorithm is used to maintain the PV operating point at the optimum point. Many MPPT techniques have been proposed in the literature.

Perturb and Observe (P&O) algorithm [1] is the most used algorithm. As the name reveals, P&O operates by perturbing either incrementing or decrementing the PV voltage periodically and then comparing the PV output power with the one of the previous perturbation cycle. Yet, this algorithm shows a bad behavior under rapid changes of irradiance and temperature and it may track a wrong point other than the optimum point.

Incremental Conductance (IC) technique [2] [3] is also a well-known algorithm. The MPP voltage is tracked as long as the condition $dp/dV = 0$ is satisfied.

Hill Climbing (HC) technique [4] [5] depends on the relationship between the PV array power and the duty cycle of the power converter. It is defined by the perturbation shown in the PWM control.

Sliding mode control (SMC) [6] [7] [8] [9] is robust to internal parameter uncertainties and external disturbances. Although the convergence rate of SMC may be arbitrarily fast, it only provides an asymptotic stability and infinite time convergence.

Modified Enhanced Perturb and Observe (MEPO), Robust Unified Control Algorithm (RUCA) and Robust Sliding Mode Control Algorithm (RSMCA) were developed in [10] [11]. These algorithms are based on the Variable Structure Control (VSC) approach. They present various advantages such as high convergence speed and simplicity.

Fuzzy logic [12] and neural network [13] are an intelligent scheme control. They have some disadvantages knowing high cost and complexity.

In this paper, the PV generation system configuration used for the comparative study is presented in section 2. The section 3 provides an overview of six MPPT algorithms: fractional open-circuit current, fractional short-circuit current, perturb and observe, incremental conductance, sliding mode control and robust unified control algorithm. With the power energy production point of view, the comparison of these MPPT algorithms is made in section 4 and the conclusions are drawn in section 5.

2. SYSTEM CONFIGURATION

The configuration of Photovoltaic Stand-alone Generation System (PGS) [14] is shown in Figure 1. The PGS mainly contains a solar array, a DC-DC power converter connected directly to the load and an MPPT control algorithm.

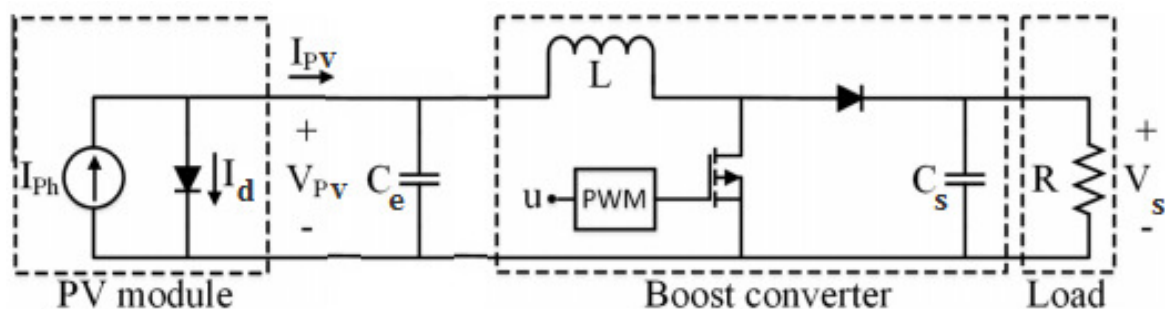

Figure 1. Photovoltaic Generation System configuration

The output current I_{pv} is

$$I_{pv} = I_{ph} - I_d \left[\exp\left(\frac{qV_{pv}}{k_bTA}\right) - 1 \right] \quad (1)$$

where I_{pv} and V_{pv} are, respectively, the output current and output voltage of the solar array.

The photo-current can be expressed by

$$I_{ph} = \left(\frac{G}{G_n}\right) [I_{scr} + k_i (T - T_r)] \quad (2)$$

The expression of the saturation current is given by

$$I_d = I_{rr} \left[\frac{T}{T_r}\right]^3 \exp\left[\frac{q}{k_bTA} \left(\frac{1}{T_r} - \frac{1}{T}\right)\right] \quad (3)$$

The DC-DC power converter is essential in photovoltaic generating systems since it ensures the adaptation of the photovoltaic panel and the load. A DC-DC converter is connected to adjust the PV array voltage V_{pv} for maximizing the power generation. We adopt a boost converter as the DC-DC power converter.

The state space average model in continuous mode of DC-DC boost converter is illustrated by

$$\begin{cases} \frac{di_L}{dt} = \frac{V_{pv}}{L} - \frac{V_s}{L}(1-u) \\ \frac{dV_s}{dt} = -\frac{V_s}{RC_s} + \frac{i_L}{C_s}(1-u) \end{cases} \quad (6)$$

where V_{pv} is the input voltage, V_s is the output voltage and i_L is the inductor current. We assume that the inductor current is equal to the PV current. The passive components R , L , C_e and C_s are respectively converter load, inductor, input and output capacitor.

3. REVIEW OF MPPT CONTROL TECHNIQUES

The P-V characteristic of the PV system is crucially influenced by solar irradiation and temperature as it is shown in Figure 2. Consequently, the PV operating point changes. As a result, an MPPT technique is needed so that the produced energy is always maintained at its maximum.

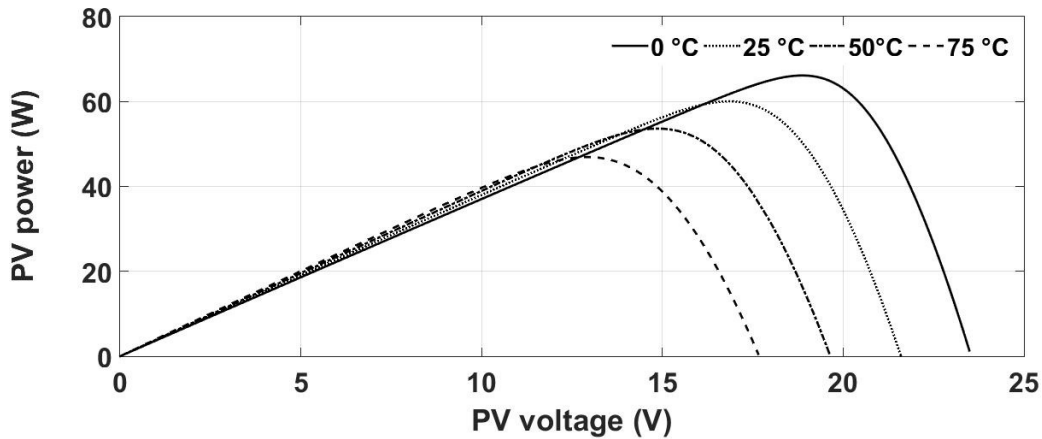

(a) Under different temperature values and fixed irradiation = 1000 W/m^2

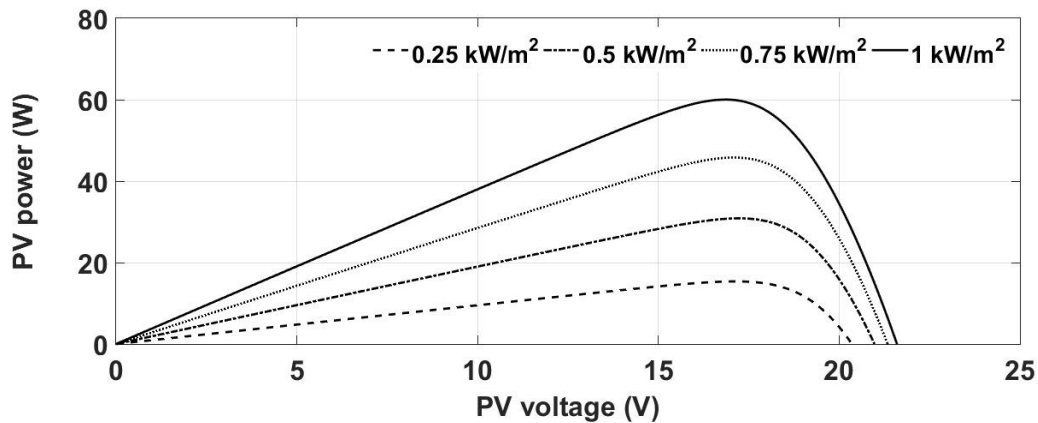

(b) Under different irradiation values and fixed temperature = 25°C

Figure 2. Power-Voltage characteristics

Many MPPT techniques are available in literature. The most used ones are introduced in this section.

3.1 Fractional Open-Circuit Voltage (FOCV)

Fractional Open-Circuit Voltage (FOCV) algorithm [15] relies on the relation between the maximum power point voltage V_{mpp} and the open circuit voltage V_{oc} . The maximum power point voltage is a constant fraction of the open circuit voltage. The fundamental relation is given by the following equation.

$$V_{mpp} = k_v \cdot V_{oc} \quad (7)$$

where k_v is the constant fraction and it is between the values 0.7 and 0.8. The open circuit voltage is measured and used as an input to the controller. As a result, it is necessary to

introduce a static switch into the PV array in order to measure the open circuit voltage. The switch must be connected in series to open the circuit.

3.1 Fractional Short-Circuit Current (FSCC)

Fractional Short-Circuit Current (FSCC) method [16] is based on the proportionality between the optimum operating current and the short circuit current. Eq. (8) shows that I_{mpp} can be determined instantaneously by detecting I_{sc} .

$$I_{mpp} = k_i \cdot I_{sc} \tag{8}$$

k_i represent the constant factor.

This technique requires measurements of the short circuit current. It is essential to introduce a static switch in parallel with the PV array to get this measurement.

3.3 Perturb and Observe (P&O)

Perturb and Observe (P&O) algorithm [1] has been widely used since it is easy for implementation. This algorithm perturbs the operating voltage to ensure maximum power. The basic flow chart of P&O algorithm is shown in Figure 3.

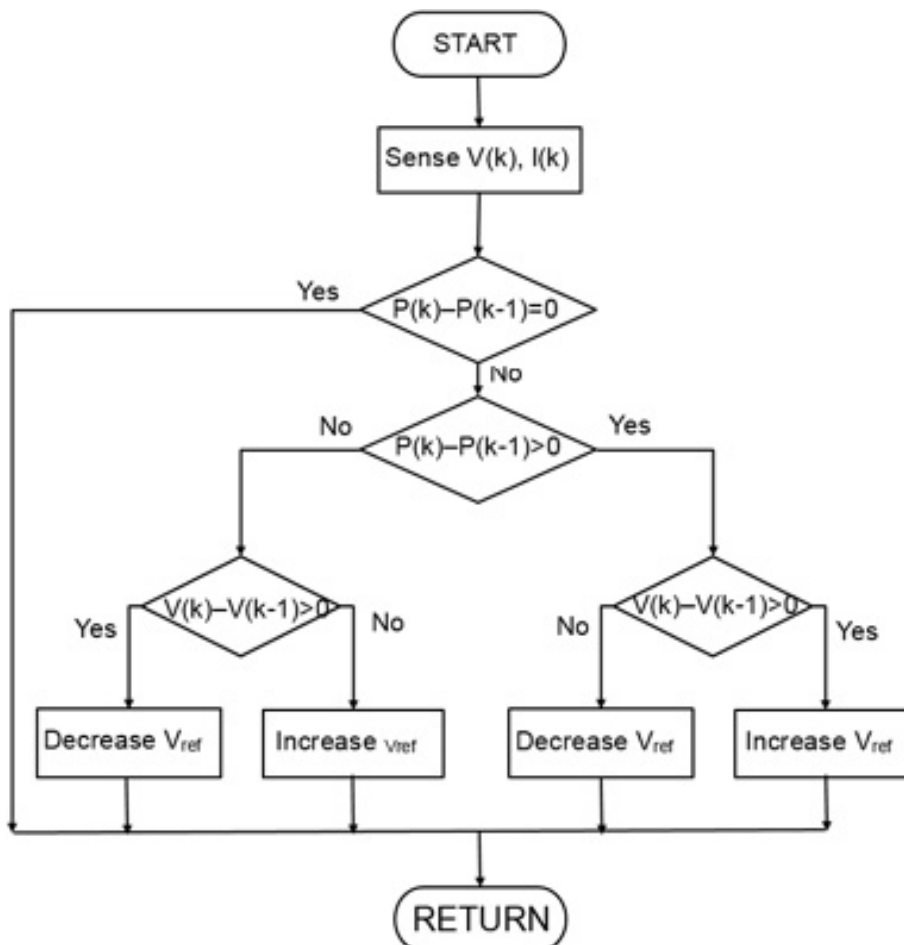

Figure 3. Basic Perturb and Observe Algorithm

P&O algorithm compares the power of the previous step and the new step so that it increases or decreases the voltage or current. Operating on the left of the MPP, it is noticeable that incrementing (decrementing) the voltage allows to increase (decrease) the power and decrease (increase) the power when on the right of the MPP. The perturbation is kept the same to reach the MPP when there is an increase in power and vice-versa. P&O has a good behavior when the irradiance does not change quickly with time. However, the power oscillates around the MPP in steady state operation and it fails with variations of temperature and irradiance.

3.4 Incremental Conductance method (IC)

The Incremental Conductance (IC) algorithm [2] [3], explained by the flow chart given by Figure 4, compares the incremental and instantaneous array conductance (dI/dV and I/V respectively) in a PV system. Depending on the result, it increases or decreases the voltage until MPP is reached.

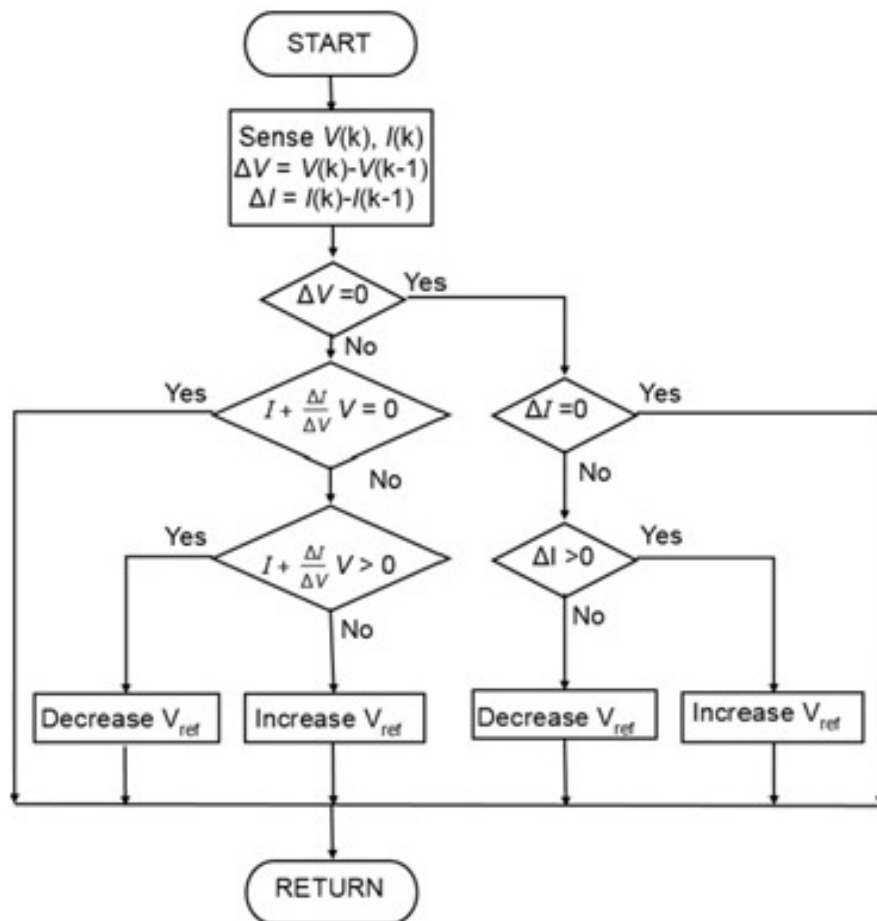

Figure 4. Basic Incremental Conductance Algorithm

- If $dP/dV < 0$ ($dI/dV < I/V$), decreasing the reference voltage forces dP/dV to approach zero;

- If $dP/dV > 0$ ($dI/dV > I/V$), increasing the reference voltage forces dP/dV to approach zero;
- If $dP/dV = 0$ ($dI/dV = I/V$), reference voltage does not need any change.

3.5 Sliding Mode Control (SMC)

Sliding mode control (SMC) [6] is known as a robust control technique and it is appropriate for controlling switched systems. For PV system, the switching surface is chosen as

$$S(t, x) = \frac{\partial I_{pv}}{\partial V_{pv}} + \frac{I_{pv}}{V_{pv}} \quad (9)$$

The global control law, sum of two the equivalent control term u_{eq} and the discontinuous control term u_{disc} , is defined as

$$u = u_{eq} + u_{disc} \quad (10)$$

where

$$\begin{cases} u_{eq} = 1 - \frac{V_{pv}}{V_s} \\ u_{disc} = -k \cdot \text{sign}(S) \end{cases} \quad (11)$$

To prove stability condition and ensure convergence property, the Lyapunov function, defined from the sliding surface already selected, is

$$V(t) = \frac{1}{2} S^2(t) \quad (12)$$

The sufficient condition can be expressed as

$$\dot{V} = S\dot{S} < 0 \quad (13)$$

In this manner, the asymptotic convergence to the sliding manifold $S = 0$ is guaranteed.

3.6 Robust Unified Control Algorithm (RUCA)

The Robust Unified Control Algorithm (RUCA) [10] [11] exploits two control inputs $u_1(k)$ and $u_2(k)$ to reach the MPP. They are used either simultaneously or alternatively.

They are defined as

$$u_1(k) = K_1 \alpha_1 \Delta P(k) \text{sign}(\Delta V(k)) \quad (14)$$

$$u_2(k) = K_2 \alpha_2 \Delta P(k) \text{sign}(\Delta I(k)) \quad (15)$$

Both inputs or only one of them can be used either $u_1(k) = \Delta V(k)$ or $u_2(k) = \Delta I(k)$. They use only one variable control and the second variable control is supposed to be zero. The convergence is proven by Lyapunov in the already cited papers.

4. SIMULATION RESULTS

The PV array is considered to have 36 cells connected in series. The PV specifications are given in Table 1. The boost converter operates with $L = 10\text{mH}$ and $C_s = 470\mu\text{F}$.

Table 1. PV specification

Parameters	Value
I_{rr}	5.981×10^{-8} (A)
I_{scr}	3.81 (A)
T_r	298 (K)
A	1.2
q	1.6×10^{-19} (C)
k_i	0.0024
k_b	1.3806×10^{-23}
P_{mpp}	60.27 (W)
V_{mpp}	16.85 (V)
I_{mpp}	3.57 (A)

4.1 MPPT algorithms comparison

Figure 5 presents the output power of the six different algorithms mentioned earlier. Under standard conditions ($1000\text{W}/\text{m}^2$ and 25°C), sliding mode control is the best MPPT algorithm since it only needs 5 ms to track the output maximum power. On the other hand, the incremental conductance needs 80 ms to reach the MPP. Although the time response of the perturb and observe and the fractional open circuit voltage is 15 ms, they oscillate around the value of the maximum power output.

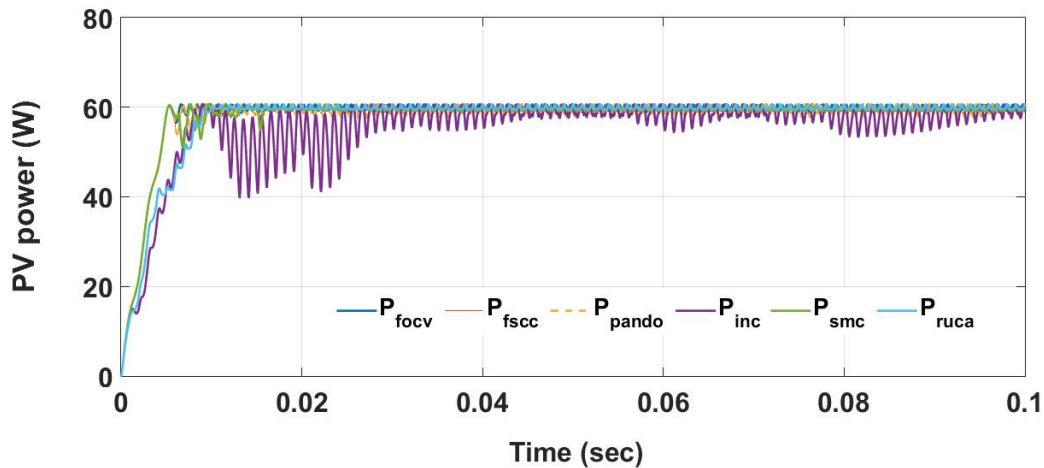

Figure 5. Simulation under standard condition: irradiation = $1000/\text{m}^2$ and temperature = 25°C

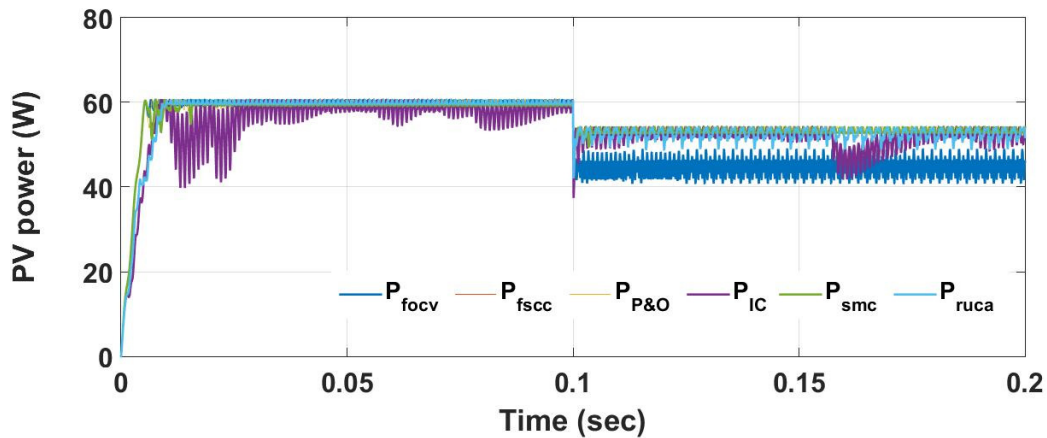

Figure 6. Simulation under step change of temperature: $25^{\circ}\text{C} \rightarrow 50^{\circ}\text{C}$ and fixed irradiation = $1000\text{W}/\text{m}^2$

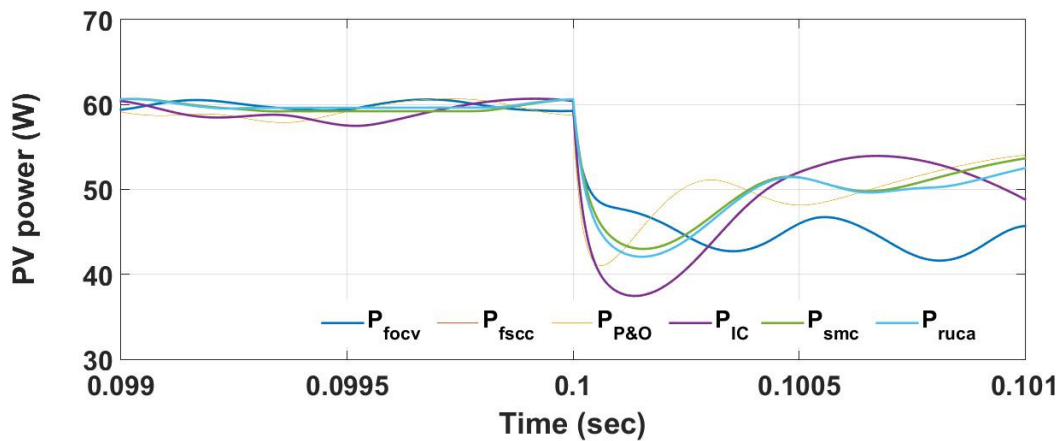

Figure 7. Zoom at $t = 0.1$ sec

The behavior of the different MPPT algorithms under cell temperature variation is shown in Figure 6. A step variation at $t = 0.1$ s is applied from 25°C to 50°C . Sliding mode control and robust unified control algorithm present the best performances. They can rapidly track and converge to the maximum power output value. The fractional open circuit voltage fails under this rapid variation. The three other algorithms take longer time to track the MPP and present some oscillations around it.

4.2 Real data measurement

In this simulation, real data are gathered at the region of Sfax, Tunisia. Two different days are selected: the first day is 21 June 2016 in the summer season as it is shown in Figure 8(a) and the second day is 21 December 2016 in the winter season presented in Figure 9(a). Sliding mode control and robust unified control algorithm are the only algorithms that have been tested since they represent the best performances than the other algorithms as it is proven from the previous simulations. For both days, SMC presents a good tracking (Figure

8(b) and Figure 9(b)) than the RUCA algorithm (Figure 8(c) and Figure 9(c)) since it has the less oscillations compared to the RUCA algorithm where the oscillations are more noticeable.

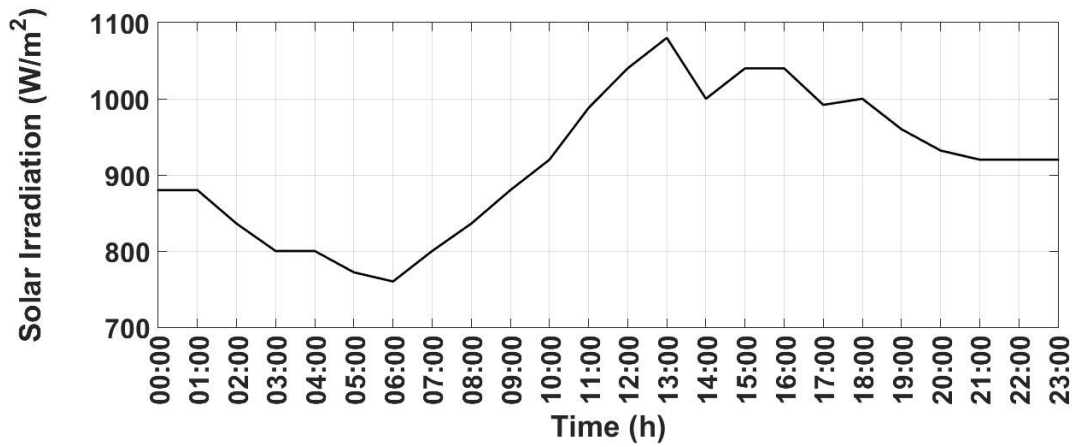

(a) Solar irradiance taken for a hot day

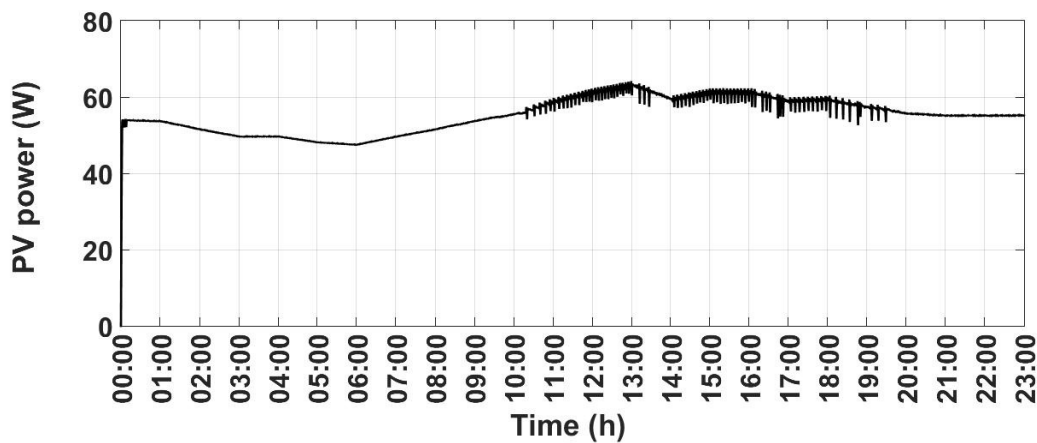

(b) Sliding Mode Control Method

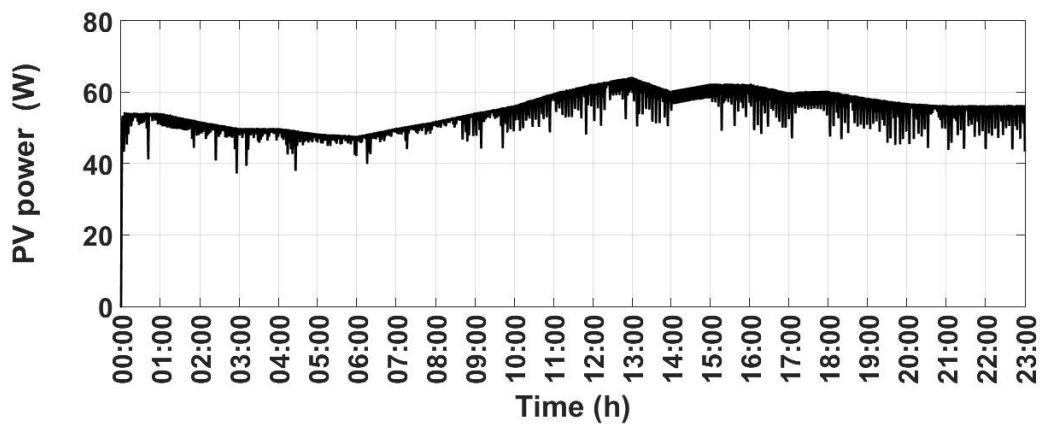

(c) Robust Unified Control Algorithm

Figure 8. Sudden variation of irradiance and temperature taken on 21 June 2016

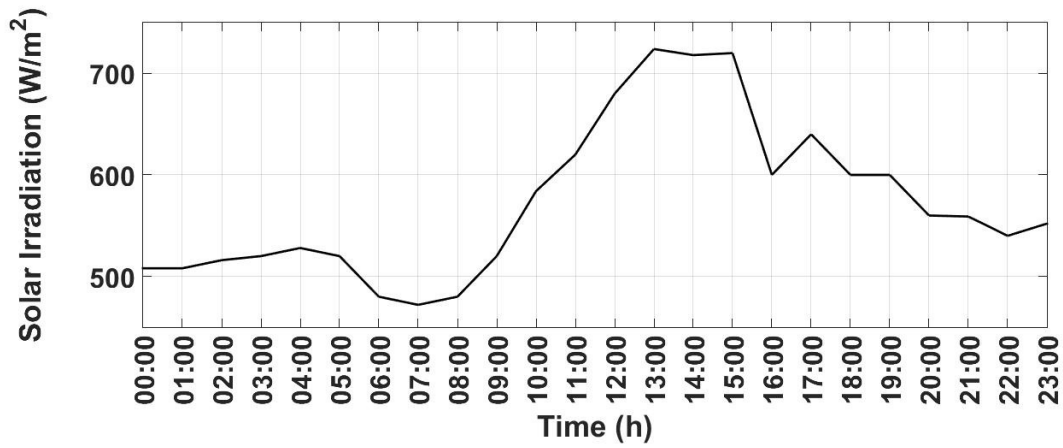

(a) Solar irradiance taken for a cold day

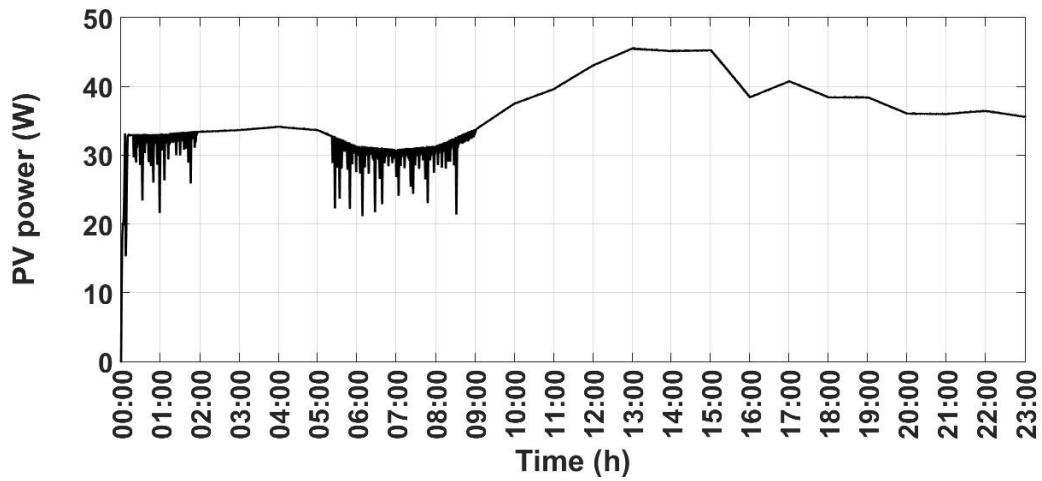

(b) Sliding Mode Control Method

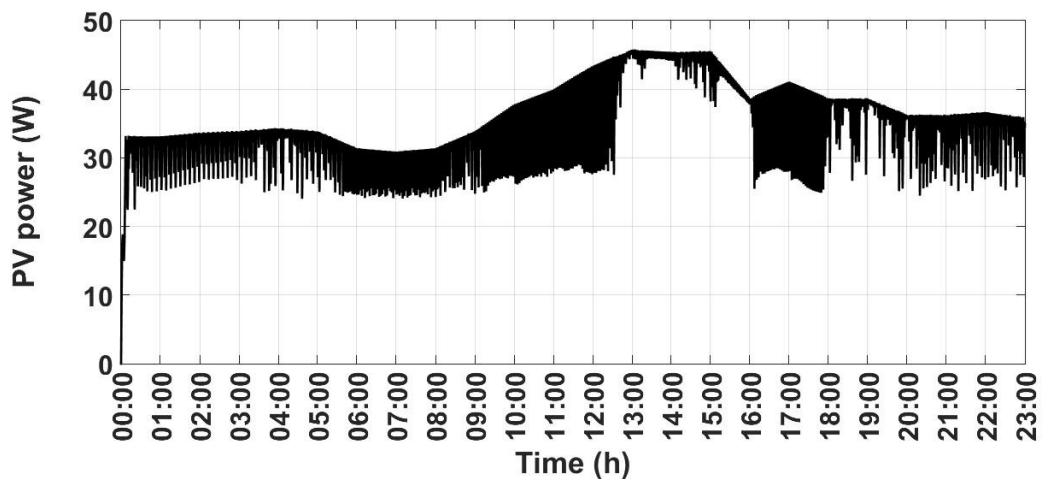

(c) Robust Unified Control Algorithm

Figure 9. Sudden variation of irradiance and temperature taken on 21 December 2016

5. CONCLUSIONS

A photovoltaic generation system which containing a PV array, DC-DC converter related to a resistive load and an MPPT algorithm is presented. The MPPT algorithm is necessary in every PV system so that the operating point is always maintained at the MPP. Six different MPPT techniques: fractional open circuit voltage, fractional short circuit current, perturb and observe, incremental conductance, sliding mode control and robust unified control algorithm are described and compared in simulation. Based on the simulation results, the performance of sliding mode control Algorithm is better than the other techniques. It can provide the maximum power and remains at it whatever the environmental conditions are.

REFERENCES

- [1] Mohamed Abdellatif Khalfa, Anis Sellami and Radhi M'hiri, Sensorless Sliding Mode Control of Induction Motor Pump fed by Photovoltaic Generator, IJ-STA, Volume 5, N°2, December 2010, pp. 1320-1337
- [2] K. Kalyan Kumar, R. Bhaskar, and Hemanth Koti. Implementation of mppt algorithm for solar photovoltaic cell by comparing short-circuit method and incremental conductance method. *Procedia Technology*, 12:705 – 715, 2014.
- [3] Ratna Ika Putria, Sapto Wibowob and Muhamad Rifa'I, Maximum power point tracking for photovoltaic using incremental conductance method, *Energy Procedia*, 68: 22 – 30, 2015
- [4] Weidong Xiao and W. G. Dunford, A modified adaptive hill climbing MPPT method for photovoltaic power systems, *IEEE 35th Annual Power Electronics Specialists Conference*, 3, pp. 1957-1963, June 2004
- [5] Nur Atharah Kamarzaman and Chee Wei Tan. A comprehensive review of maximum power point tracking algorithms for photovoltaic systems. *Renewable and Sustainable Energy Reviews*, 37:585 – 598, 2014.
- [6] Ben Hamed-M. & Sbita-L. Garraoui, R. A robust optimization technique based on first order sliding mode approach for photovoltaic power systems. *Int. J. Autom. Comput.*, 12:620–629, 2015.
- [7] Chen-Chi Chu and Chieh-Li Chen. Robust maximum power point tracking method for photovoltaic cells: A sliding mode control approach. *Solar Energy*, 83(8):1370 – 1378, 2009.
- [8] Chan-Yu Ku Chian-Song Chiu, Ya-Lun Ouyang. Terminal sliding mode control for maximum power point tracking of photovoltaic power generation systems. *Solar Energy*, page 29862995, 2012.
- [9] E. Mamarelis, G. Petrone, and G. Spagnuolo. Design of a sliding mode-controlled sepic for pv mppt applications. *IEEE Transactions on Industrial Electronics*, 61(7):3387–3398, July 2014.
- [10] N. K. M'Sirdi, B. Nehme, M. Abarkan, and A. Rabbi. The best mppt algorithms by vsas approach for renewable energy sources (res). *Environmental Friendly Energies and Applications (EFEA)*, 2014 3rd International Symposium on, pages 1–7, Nov 2014.
- [11] Nacer K. M'Sirdi, A. Rabhi, and M. Abarkan. A new vsas approach for maximum power

tracking for renewable energy sources. *Energy Procedia*, 42:708 – 717, 2013.

- [12] B. Bendiba,b, F. Krimb , H. Belmilia , M. F. Almia , S. Bouloumaa, Advanced Fuzzy MPPT Controller for a stand-alone PV system, *Energy Procedia* 50 (2014) 383–392
- [13] Rihab Mahjoub Essefi, Mansour Souissi and Hsan Hadj Abdallah, Maximum Power Point Tracking Control Using Neural Networks for Stand-Alone Photovoltaic Systems, *International Journal of Modern Nonlinear Theory and Application*, 2014, 3, 53-65
- [14] Adel El Shahat, Stand-alone PV System Simulation for DG Applications, Part I: PV Module Modeling and Inverters, *J. Automation & Systems Engineering* 6-2 (2012): 36-54
- [15] J. Ahmad, A fractional open circuit voltage based maximum power point tracker for photovoltaic arrays, 2nd International Conference on Software Technology and Engineering, October 2010
- [16] Hadeed Ahmed Sher, Ali F. Murtaza, Abdullah Noman, Khaled E. Addoweesh, and Marcello Chiaberge, An intelligent control strategy of fractional short circuit current maximum power point tracking technique for photovoltaic applications, *Journal of RENEWABLE AND SUSTAINABLE ENERGY* 7, 013114 (2015)