



**HAL**  
open science

## Adaptive Prediction for Ship Motion in Rotorcraft Maritime Operations

Antoine Monneau, Nacer Msirdi, Sébastien Mavromatis, Guillaume Varra,  
Marc Salesse, Jean Sequeira

► **To cite this version:**

Antoine Monneau, Nacer Msirdi, Sébastien Mavromatis, Guillaume Varra, Marc Salesse, et al.. Adaptive Prediction for Ship Motion in Rotorcraft Maritime Operations. 5th CEAS Specialist Conference on Guidance, Navigation & Control - EUROGNC, Apr 2019, MILAN, Italy. hal-02095955

**HAL Id: hal-02095955**

**<https://amu.hal.science/hal-02095955v1>**

Submitted on 22 May 2020

**HAL** is a multi-disciplinary open access archive for the deposit and dissemination of scientific research documents, whether they are published or not. The documents may come from teaching and research institutions in France or abroad, or from public or private research centers.

L'archive ouverte pluridisciplinaire **HAL**, est destinée au dépôt et à la diffusion de documents scientifiques de niveau recherche, publiés ou non, émanant des établissements d'enseignement et de recherche français ou étrangers, des laboratoires publics ou privés.

# Adaptive Prediction for Ship Motion in Rotorcraft Maritime Operations

Antoine Monneau<sup>1,2</sup>, Nacer K M'Sirdi<sup>1</sup>, Sebastien Mavromatis<sup>1</sup>, Guillaume Varra<sup>2</sup>, Marc Salesse<sup>2</sup> and Jean Sequeira<sup>1</sup>

**Abstract** This paper focus on prediction of motion for a ship navigating through sea swell. Ship motion prediction may be useful for helicopter maritime operations and notably for search and rescue missions. An efficient prediction method based on ANF (Adaptive Notch Filters) is proposed for non stationary perturbations. Classical methods of prediction are reviewed for comparison. An application using real ship motion data is carried out for performance evaluation. Finally a comparative analysis based on prediction performance and real time implementation constraints is presented.

## 1 Introduction

### 1.1 Context

Search And Rescue (SAR) missions represent a technological and human challenge among the most difficult ones. This is especially true when they are aimed at rescuing people on board a sinking boat. Hoisting from an helicopter remains the only solution to quickly intervene and evacuate people in distress. This operation is often challenging for the pilot because it forces him to stabilize the helicopter above the moving boat and to precisely position the rescuer on the deck. Weather conditions are often unfavorable, resulting in wide movements of the boat and its mast if it has one. In this situation, the pilot's workload is very high and the risk of collision between the rescuer

---

Antoine Monneau, Nacer K M'Sirdi, Sebastien Mavromatis and Jean Sequeira

<sup>1</sup> Informatics and Sciences Laboratory (LIS) UMR CNRS 7020 of AMU, the Aix Marseille University, e-mail: nacer.msirdi@lis-lab.fr

Antoine Monneau, Guillaume Varra and Marc Salesse

<sup>2</sup> Airbus Helicopters, Marignane, e-mail: antoine.monneau@lis-lab.fr

and the boat is not negligible. To make the pilot's task easier and to reduce the risk of collision, knowing the boat's movement over a time horizon of a few seconds can be very useful. In addition, sending this prediction information to the helicopter autopilot can help stabilize the machine in a safe area and accurately bring the rescuer to the estimated landing point. Prediction of boat movements is therefore essential to increase the safety of SAR missions. Another example of the potential utility of ship motion prediction is for missions of maritime pilot hoisting on tanker ships. During night operation, the long deck of tankers can be mistaken with the horizon. Large and slow movements of the ship can disorientate the helicopter pilot and lead to dangerous control of the machine. Knowing the ship attitudes few seconds in advance can significantly help the autopilot to follow the ship. This will let the pilot to focus his attention on safety aspects of the hoisting operation.

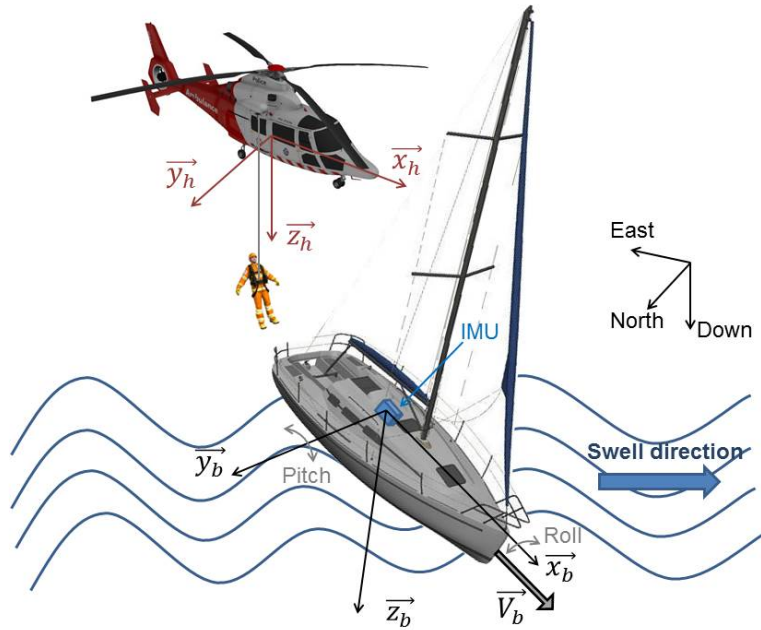

Fig. 1: Helicopter hoist operation during a SAR mission

## 1.2 Objective and Contribution

The context of our work is the navigation and control of helicopters with avoidance of environment perturbation effects. In SAR the ship movements, under swell, are considered as environment perturbations. In the context of estimation of perturbations [1], specific features have to be considered. For

a moving ship excited by swell, the perturbations are non stationary and their frequency spectrum is composed by narrow bands with slowly varying frequencies and varying amplitudes and phases .

Adaptive Notch Filters are well suited for prediction of non stationary narrow band perturbations [1, 2]. It is often crucial to detect and predict the perturbation signals in order to compensate or tackle their effects. Several prediction methods (ARMA, MCA and ANF) will be presented and compared. For safe stabilization of an helicopter moving above a ship, adaptive prediction is well suited for perturbations compensation and avoidance of deviations of the ship movements.

Our main objective is to get a good prediction of the main perturbations over few seconds in order to compensate their effect in control for a good trajectory following [3, 4, 5]. We will focus on the prediction of attitudes and linear speeds of a moving ship. Then our main contribution will be in the definition of a pertinent and efficient prediction method.

This paper is organized as follows. After this introduction, section 2 is devoted to the related previous works in literature and background definition. In section 3 we present several prediction approaches using some well known methods like ARMA modeling or Minor Component Analysis (MCA) and then propose the use of Adaptive Notch Filters (ANF). The proposed approach, based on the ANF, will be shown to be the most efficient and fast adaptive predictor. The section 4 presents an application of the presented methods on real data acquired on a ship maneuvering under swell perturbation. Finally a comparative study is carried out. This will emphasize the interest to use the proposed method based on ANF for ship motion prediction.

## 2 Background and Previous Work

### 2.1 Background

Figure 1 presents the environment of a helicopter hoist operation in SAR mission. Given a boat (coordinate system  $R_b: (\vec{x}_b, \vec{y}_b, \vec{z}_b)$ ) navigating on a rough sea with speed  $\vec{V}_b$ . Swell perturbation causes the boat to rotate around  $\vec{x}_b$  (roll axis) and  $\vec{y}_b$  (pitch axis). The final objective consists in guiding the helicopter (coordinate system  $R_h: (\vec{x}_h, \vec{y}_h, \vec{z}_h)$ ) so that the rescuer (in orange on the figure 1) hanging on the hoisting rope land safely on the boat aft deck.

We propose to predict the boat motions with a prediction horizon of few seconds. In the future, this information will be use by the helicopter autopilot to ensure a safe hoist operation. Ship motions are typically characterized by attitudes (roll  $\phi$  and pitch  $\theta$ ) and translation speeds at the center of gravity

(longitudinal  $Vx_b$ , lateral  $Vy_b$  and vertical  $Vz_b$ ). These movements are caused by the swell encountered by the ship and are explained by the sea-keeping theory. In this study the signals characterizing ship movements are provided by an Inertial Measurement Unit (IMU) located at the center of mass. Roll angle of a ship navigating on a formed sea is presented on figure 2.

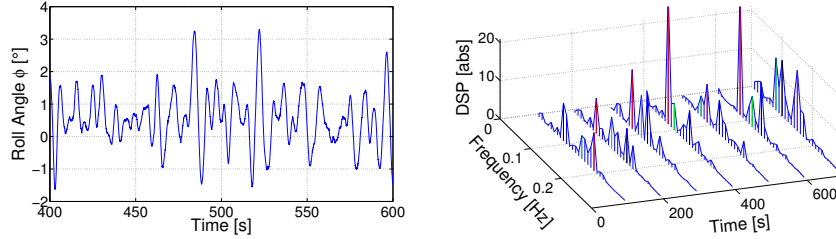

Fig. 2: Roll attitude angle measurement  $\phi(t)$  and its spectrum evolution with time

When looking at the time evolution of roll spectrum on figure 2, the signal appears to be non-stationary in amplitudes and phases. The non-stationary feature is due to change of sea state or modification of the track followed by the ship. It clearly appears that the signals are composed by a limited number of frequencies in  $0.05Hz < f_i < 0.25Hz$  range with varying amplitudes.

## 2.2 Previous work

There are two common approaches to predict the movements of a boat. The first one is to build a dynamic model capable of capturing the main characteristics of the system  $\{boat + environment\}$ . In this case, the entire system needs to be modeled, such as uncertain stochastic processes (swell, wind), the dynamic behavior of the ship as well as the unknown dynamics. Prediction methods using such models are very dependent on the reliability of their identification. A complete modeling of boat dynamics requires a precise knowledge of hydrodynamic parameters as well as sea state around the boat. In practice, it would be tedious if not impossible to build a precise model since many parameters (frequency of swell, angle of attack of the swell, configuration of the ship, etc.) are not available.

Alternatively, the system can be handled as a black box and then be approximated by a model that implicitly captures its characteristics. This model can be represented in the time domain by a linear recursive sequence with coefficients that are estimated over time. Time prediction of motions are then generated using the temporal model without building or solving dynamic equations intrinsic to the ship, and only on the basis of previous measurements of motion.

### 2.2.1 Time prediction based on state model

The dynamics of vessel have been studied in many works in the past decades. The sea-keeping theory studies dynamics of a ship navigating on sea and assumes that its movements are oscillating around a point of equilibrium [6]. Moreover this theory suggests that swell height is a Gaussian stochastic process with zero mean. Nevertheless this hypothesis is too strong and limits the application of sea-keeping theory for studying ship dynamics. Motion prediction using ship state models has been extensively studied in a large number of articles, and significant efforts have been made to deal with various practical problems. Triantafyllou et al. [7] used the Kalman filtering technique to predict six states of a ship. They use a precise state model that requires prior knowledge of hydrodynamic data. A significant effort of computation is necessary to extract these data. In addition several transfer functions between the ship's movements and the swell elevation are irrational functions with no minimum of phase making their use tricky. Lainiotis et al. [8] have developed a method for estimating the ship's movements based on a state model, but again it relies entirely on the prior knowledge of a large number of intrinsic parameters.

### 2.2.2 Time prediction based on temporal model

The use of time series is an alternative to realize ship motion prediction. Only past records of movements are needed to generate time prediction. The construction of a temporal model involves the determination of the orders of the model as well as its parameters. For example, X. Yang proposes a variant of online auto-regressive predictor that shows accurate prediction results on simulated data (error within 10% for 12.5 seconds prediction) [9]. An interesting Auto-Regressive External input model (ARX) had been used for real time motion prediction of a 210 tons ship in 1979 [10]. Wave height in front of the ship (external input) was obtained via a pressure sensor located at bulbous bow. Results show good prediction of amplitudes for 2 to 4 seconds in advance and good prediction of phases for 8 to 10 seconds. A prediction algorithm using Minimal Component Analysis (MCA) of the signal of the movement was introduced by Zhao et al. [11]. The generated prediction requires important computing resources to update the model parameters which makes it complicated to implement on board. A sinusoidal approach of ship motion was developed by Ra and al. The roll motion is considered to be a sinus whose the slow varying frequency is estimated in real time by a recursive least squares algorithm [12]. Amplitude and phase of the sinus are supposed to remain constant.

### 3 Prediction Methods

With the only availability of signal past values, prediction methods are based on statistical analysis. The most commonly used method generates a  $d$  step ahead prediction from an Auto-Regressive Moving Average model (ARMA) which is identified recursively. Another much less common method uses a variant of the Principal Component Analysis (PCA or Karhunen-Loeve transformation). It is known as Minor Component Analysis because it uses the signal low projection on the minimum axes. In both cases, the past signal is processed to identify its generator model (ARMA) or to extract its principal components (PCA). Then we use this knowledge to generate a prediction over a few seconds. It is assumed that the characteristics of the signal do not change over the prediction period. A third approach considers ship movements as a sum of sinusoidal signals. Real-time estimation of frequencies, amplitudes and phases of these sinusoidal components leads to built signal spectrum with time. Spectrum parameters are then frozen to generate time prediction. The difficulty here is to proceed real-time spectral analysis with time-varying parameters. Adaptive Notch Filters offer a way in frequencies tracking for narrow band signals. Amplitudes and phases can be estimated using a Weighted Recursive Least Squares algorithm.

Note that in these 3 methods, no additional information (hydrodynamic parameters, boat speed and track, wave spectrum, etc..) are required to generate the prediction.

#### 3.1 ARMA Predictions

##### **Auto Regressive Moving Average model:**

An auto-regressive moving average (ARMA) model of order  $(n_a, n_c)$  is defined as:

$$y_k = - \sum_{i=1}^{n_a} a_i y_{k-i} + \sum_{i=1}^{n_c} c_i e_{k-i} + e_k \quad (1)$$

where  $a_i, c_i$  are the coefficients of the model and  $e_k$  is white noise.

This model supposes that the signal value at instant  $k$  is a linear combination of its past values. Before using equation 1 for prediction, parameters  $a_i$  and  $c_i$  need to be identified.

##### **Parameters identification:**

Parameters identification consists in minimizing the prediction error defined as:

$$\epsilon_k = y_k - \phi_k^T \hat{\theta} \quad (2)$$

where:

- $\phi_k = [-y_{k-1} \dots -y_{k-n_a} \ e_{k-1} \dots e_{k-n_c}]^T$  the regression vector
- $\hat{\theta} = [\hat{a}_1 \dots \hat{a}_{n_a} \ \hat{c}_1 \dots \hat{c}_{n_c}]^T$  is the parameter vector estimate

In our case, the signal is non-stationary and ARMA model parameters are time-varying. Consequently, the minimization of  $\epsilon_k$  is made with a weighting that favors latest past values. A forgetting factor  $\lambda < 1$  is then added to the minimization.

The criterion to minimize can be written as:

$$J_N = \frac{1}{N} \sum_{k=1}^N \lambda^{N-k} \left( y_k - \phi_k^T \hat{\theta} \right)^2 \quad (3)$$

with  $N$  the number of available signal sample.

The Least Squares (LS) solution of the minimization is given by the following equation:

$$\hat{\theta} = \underset{\theta}{arg \ min}(J_N) = \left[ \frac{1}{N} \sum_{k=1}^N \lambda^{N-k} \phi_k \phi_k^T \right]^{-1} \left[ \frac{1}{N} \sum_{k=1}^N \lambda^{N-k} \phi_k y_k \right] \quad (4)$$

In order to estimate the parameters vector  $\theta$  with equation 4, signal covariance matrix  $\frac{1}{N} \sum_{k=1}^N \phi_k \phi_k^T$  needs to be computed and inverted at each step. For large values of  $N$ , this operation can require considerable computational effort ( $O(N^3)$ ). It is judicious to use the Recursive form of Least-Squares (RLS) algorithm and use previous estimation of  $\hat{\theta}$ .

Real-time estimation of parameters vector can be done using Weighted Recursive Least-Squares Algorithm (WRLS) given by [13]:

$$\begin{cases} \hat{\theta}_k = \hat{\theta}_{k-1} + \frac{F_{k-1} \phi_k}{\lambda + \phi_k^T F_{k-1} \phi_k} \cdot \left( y_k - \phi_k^T \hat{\theta}_{k-1} \right) \\ F_k = \frac{1}{\lambda} \left[ F_{k-1} - \frac{F_{k-1} \phi_k^T \phi_k F_{k-1}}{\lambda + \phi_k^T F_{k-1} \phi_k} \right] \end{cases} \quad (5)$$

with  $F_k$  the adaptation gain, starting at a large value (typically 100) and fading to zero when the prediction error  $\epsilon_k$  becomes low. The forgetting factor  $\lambda$  is usually chosen between 0.98 and 0.995.

### Model order selection:

The selection of the model order is crucial: a low order will not capture all



system dynamics and leads to high prediction error variance whereas a high order implies large computational effort.

To help the order selection, many criteria are available in the literature. Akaike Information Criterion (AIC) is widely used:

$$AIC(n_a, n_c) = \log \hat{\sigma}^2 + \frac{2(n_a + n_c)}{N} \quad (6)$$

with  $\hat{\sigma}^2$  the prediction error covariance estimate defined as:

$$\hat{\sigma}^2 = \frac{1}{N - n_a - n_c} \sum_{k=n_a+n_c+1}^N \left( y_k - \phi_k^T \hat{\theta}_{k-1} \right)^2 \quad (7)$$

The first term of equation 6 measures the model fit based on the error prediction covariance  $\hat{\sigma}$ . The second term corresponds to the penalization of complex model ( $n_a, n_c$  high). The model orders ( $n_a, n_c$ ) corresponding to the lowest AIC value must be chosen.

Unfortunately AIC is not adapted to our problem, this criterion tends to over-estimate the model order and the estimate is not consistent for large  $N$  (which is our case). In fact, the probability to select the true model does not tend to one when  $N$  tends to infinity. According to J. Kuha [14], this probability is upper bound by 0.84 .

G. Schwarz [15] suggests the Bayesian Information Criterion (BIC) that provides a consistent estimate of ( $n_a, n_c$ ), it is defined as:

$$BIC(n_a, n_c) = \log \hat{\sigma}^2 + \frac{(n_a + n_c) \log N}{N} \quad (8)$$

#### Time prediction at instant $k+d$ :

The prediction of  $y_k$ , signal at instant  $k$ , uses the last identified parameters and the last  $n_a$  past values of  $y_k$ :

$$\hat{y}_k = -\hat{a}_1 y_{k-1} - \hat{a}_2 y_{k-2} \dots - \hat{a}_{n_a} y_{k-n_a} + \hat{c}_1 e_{k-1} + \hat{c}_2 e_{k-2} \dots + \hat{c}_{n_c} e_{k-n_c} \quad (9)$$

Then, for the  $d$  step ahead prediction  $\hat{y}_{k+d}$ , we use the previous predictions  $\hat{y}_{k+d-i}$  to compute:

$$\hat{y}_{k+d} = -\hat{a}_1 \hat{y}_{k+d-1} - \hat{a}_2 \hat{y}_{k+d-2} \dots - \hat{a}_{n_a} \hat{y}_{k+d-n_a} + \hat{c}_1 e_{k-1} \dots + \hat{c}_{n_c} e_{k-n_c} \quad (10)$$

We suppose that the parameters are constant over the prediction horizon, meaning that the signal is supposed stationary over this period.

### 3.2 Minor Component Analysis and Prediction

Principal Component Analysis (PCA) is a statistical method that aims to transform observations of correlated variables into linearly uncorrelated ones. These new variables are called principal components or principal axes. This analysis permits to reduce the number of variables to describe a process and makes the information less redundant.

The name "principal axes" is interesting as it refers to vocabulary of mechanics. Indeed, principal axes correspond to vectors that maximize the projected inertia of points cloud on themselves. It is equivalent to state that they are vectors that minimize the moment of inertia around themselves (the distribution of mass). For example the principal axis of a helicopter is parallel to the longitudinal axis as the moment of inertia around this axis is minimum. That explains relatively high roll rate compared to pitch or yaw axes. Minor Component Analysis focus on minor axes where the projected inertia on themselves are minimum.

#### Notations

Given variables  $Y_1, Y_2, \dots, Y_P$  that represent the signal  $y_k$  on time shifted windows of length  $N$ .

We define the variables  $Y_j$ , with  $j \in \llbracket 1; P \rrbracket$  as follows:

$$\begin{aligned} Y_1 &= [y_1 \ y_2 \ \cdots \ y_N]^T \\ Y_2 &= [y_2 \ y_3 \ \cdots \ y_{N+1}]^T \\ &\vdots \\ Y_P &= [y_P \ y_{P+1} \ \cdots \ y_{P+N-1}]^T \end{aligned} \quad (11)$$

We suppose that  $Y_j$  are centered, meaning that the expected value of these variables have been subtracted.

Point cloud associated with the centered variables can be written with matrix form:

$$M = [Y_1 \ Y_2 \ \cdots \ Y_P] = \begin{bmatrix} y_1 & y_2 & \cdots & y_P \\ y_2 & y_3 & \cdots & y_{P+1} \\ \vdots & \vdots & & \vdots \\ y_N & y_{N+1} & \cdots & y_{P+N-1} \end{bmatrix} \quad (12)$$

#### Component Analysis

The projection of the point cloud  $M$  on a vector  $u \in \mathbb{R}^{P \times 1}$  is  $\Pi_u(M) = M \cdot u$ . Projected inertia of the point cloud on the vector  $u$  is defined as:

$$I_M(u) = \frac{1}{N} \Pi_u(M)^T \Pi_u(M) = \frac{1}{N} u^T M^T M u = u^T C u \quad (13)$$

where  $C = \frac{1}{N} M^T M \in \mathbb{R}^{P \times P}$  the covariance matrix of variables  $Y_j$ . We are looking for the vector  $u$  that minimize (or maximized) the projected inertia  $I_M(u)$ .

The correlation function of the signal  $y_k$  is defined in discrete time as:

$$R_{yy}(k) = E \left[ Y_j^T Y_{j+k} \right] = \frac{1}{N} \sum_{i=j}^{N+j-1} y_i \cdot y_{i+k} \quad \text{for } j \in \llbracket 1; P \rrbracket \quad (14)$$

Autocorrelation matrix of the signal is defined as:

$$R_y = \begin{pmatrix} R_{yy}(0) & R_{yy}(1) & R_{yy}(2) & \cdots & R_{yy}(P-1) \\ R_{yy}(1) & R_{yy}(0) & R_{yy}(1) & \cdots & R_{yy}(P-2) \\ R_{yy}(2) & R_{yy}(1) & R_{yy}(0) & \cdots & R_{yy}(P-3) \\ \vdots & \vdots & \vdots & \ddots & \vdots \\ R_{yy}(P-1) & R_{yy}(P-2) & R_{yy}(P-3) & \cdots & R_{xx}(0) \end{pmatrix} \quad (15)$$

According to equations 13, 14 and 15 we note that the autocorrelation matrix  $R_y$  and the covariance matrix of  $Y_j$  variables  $C$  are equal. Moreover,  $R_y$  is symmetric real, consequently it can be diagonalized in an orthonormal basis composed of eigenvectors:

$$R_y = V \Delta V^T \quad (16)$$

where:

- $V = [V_1 \ V_2 \ \cdots \ V_d \ \cdots \ V_P] \in \mathbb{R}^{P \times P}$  matrix of eigenvectors
- $\Delta = \text{diag}(\lambda_1, \lambda_2, \cdots, \lambda_d, \cdots, \lambda_P) \in \mathbb{R}^{P \times P}$  matrix of eigenvalues

We suppose that  $R_y$  eigenvalues are ordered in the following manner:

$$\lambda_1 \leq \lambda_2 \leq \cdots \leq \lambda_d \leq \cdots \leq \lambda_P \quad (17)$$

Projection of inertia on vector  $u$  becomes:

$$I_M(u) = u^T R_y u = u^T V \Delta V^T u = Q^T \Delta Q \quad (18)$$

where  $Q$  is the vector  $u$  in the eigenvectors basis  $(V_1, V_2, \cdots, V_n)$  :

$$Q(u) = V^T u = [q_1 \ \cdots \ q_P]^T \quad (19)$$

Projection of inertia on vector  $u$  becomes:

$$I_M(u) = \sum_{k=1}^P \lambda_k q_k^2 \leq \lambda_P \sum_{k=1}^P q_k^2 \leq \lambda_P \quad (20)$$

Projected inertia  $I_M(u)$  is upper bound by  $\lambda_P$  and is reached when  $u = V_P$ . This is the principal axis, the variance of the projection of cloud point on  $V_P$  is  $\lambda_P$ . The second axis corresponds to  $V_{P-1}$  eigenvector (projection variance  $\lambda_{P-1}$ ) and is orthogonal to the principal axis. And so on up to  $V_1$  which corresponds to the minor axis with the lowest projection variance  $\lambda_1$ . The eigenvectors associated with highest eigenvalues are used in Principal Component Analysis (PCA) whereas the ones with lowest eigenvalues are used in Minor Component Analysis (MCA).

### Time prediction using MCA

We choose the lowest eigenvalues:  $\lambda_1, \lambda_2, \dots, \lambda_d$  associated with their eigenvectors:  $V_1, V_2, \dots, V_d$ .

We call  $B$  the matrix of eigenvectors associated to lowest eigenvalues:

$$B = [V_1 \ V_2 \ \dots \ V_d] = \begin{bmatrix} v_{11} & v_{12} & \dots & v_{1d} \\ v_{21} & v_{22} & \dots & v_{2d} \\ \vdots & \vdots & & \vdots \\ v_{P1} & v_{P2} & \dots & v_{Pd} \end{bmatrix} \quad (21)$$

The projection of the signal  $Y = [y_1 \ y_2 \ \dots \ y_P]^T$  on the eigenvectors basis  $(V_1, V_2, \dots, V_d)$  has a very low variance.

$$B^T Y \approx 0 \quad (22)$$

The signal  $Y$  can be cut in two parts  $Y_a \in \mathbb{R}^{n_1 \times 1}$  and  $Y_b \in \mathbb{R}^{P-n_1 \times 1}$  where:

$$Y_a = [y_1 \ y_2 \ \dots \ y_{n_1}]^T \quad \text{and} \quad Y_b = [y_{n_1+1} \ y_{n_1+2} \ \dots \ y_P]^T \quad (23)$$

Likewise, the matrix  $B^T$  is cut into  $B_a^T \in \mathbb{R}^{d \times n_1}$  and  $B_b^T \in \mathbb{R}^{d \times P-n_1}$  and we have:

$$B_a^T Y_a + B_b^T Y_b \approx 0 \quad (24)$$

As for ARMA prediction, we suppose that the process is stationary over the prediction horizon. Eigenvectors describing the signal are not changing,  $B_a^T = B_{past}^T$  and  $B_b^T = B_{pred}^T$  are constant.

We can then generate a prediction of the  $P - n_1$  next values with:

$$B_{past} Y_{past} + B_{pred} Y_{pred} \approx 0 \quad (25)$$

where  $Y_{pred} = [y_k \ \dots \ y_{k+P-n_1-1}]^T \in \mathbb{R}^{P-n_1 \times 1}$  is the predicted signal and  $Y_{past} = [y_{k-n_1} \ \dots \ y_{k-1}]^T \in \mathbb{R}^{n_1 \times 1}$  is the past signal.

Finally we get:

$$Y_{pred} \approx - \left( B_{pred}^T B_{pred} \right)^{-1} B_{pred}^T B_{past} Y_{past} \quad (26)$$

### Implementation

First step consists in computing the autocorrelation matrix  $R_y$  of the signal  $y_k$  using the last  $P + N - 1$  available measurements. Only  $P$  values of the correlation function need to be computed to form  $R_y$  as the matrix is Toplitz and symmetric. Then the eigenvectors associated to eigenvalues of  $R_y$  have to be extracted. As  $R_y$  is positive semi-definite, Singular-Value Decomposition algorithm can be used to compute  $\lambda_j$  and  $V_j$  efficiently. The  $d$  smallest eigenvalues and their eigenvectors are then selected. Typically, we choose the eigenvalues lower than 1.5% of the total energy of  $\Delta$ :

$$d = \max(i) \quad \text{such as} \quad \lambda_i \leq \frac{1.5}{100} \cdot \sum_{k=1}^P \lambda_k \quad (27)$$

Resulting minor eigenvectors matrix  $B^T$  is then split in two parts  $B_{past}$  (dimension  $d \times n_1$ ) and  $B_{pred}$  (dimension  $d \times P - n_1$ ).  $n_1$  is typically chosen to be larger than  $\frac{2}{3}N$  according to G. Zhao [11]. The  $P - n_1$  steps prediction is then generated using equation 26. Note that inversion of  $B_{pred}^T B_{pred}$  is not necessary here, QR decomposition of  $B_{pred}$  will ease  $Y_{pred}$  computation.

Length of  $Y_{pred}$  gives us the prediction horizon:  $P - n_1$ . Given that  $n_1 = \frac{2}{3}N$ , prediction horizon becomes  $P - \frac{2}{3}N$ . Window length  $N$  has to be small enough to get long horizon, however the window needs to capture system dynamics. Typically a window corresponding to 3 periods is chosen. Use of large  $P$  increases prediction horizon, nevertheless it is synonym of higher computation load (autocorrelation matrix formation). Moreover use of very old past values of the signal (until  $y_{k-N-P-1}$ ) prevents to follow time-varying characteristics of ship motion.

### 3.3 Adaptive Notch Filters Predictions

Ship motions can be explained by the seakeeping theory which supposes that the ship is oscillating around an equilibrium point. The signals describing these movements can be seen as a sum of sinusoids with time varying frequencies  $f_i(k)$ , amplitudes  $C_i(k)$  and phases  $\beta_i(k)$ .

$$y_k = \sum_{i=1}^n C_i(k) \cdot \text{Sin}(2 \cdot \pi \cdot f_i(k) \cdot T_s \cdot k + \beta_i(k)) \quad (28)$$

Time prediction of this signal relies on accurate online estimation of its time varying components in noise. Recently introduced adaptive identifica-

tion technique uses frequency estimation of narrow band signals based on Adaptive Notch Filter (ANF) [16]. Online amplitudes and phases estimation are made using Weighted Recursive Least-Squares algorithm on a Fourier decomposition.

### Frequency estimation with cascaded ANF:

Adaptive Notch Filters are well known for extracting frequencies of signals composed of sinusoidal components. For example, the following second order ANF filters the  $i^{th}$  sinusoidal component (frequency  $f_i$ ) of a given signal:

$$H_i(z^{-1}) = \frac{1 + a_i z^{-1} + z^{-2}}{1 + r \cdot a_i z^{-1} + r^2 z^{-2}} \quad (29)$$

where:

- $a_i = -2\cos(2\pi f_i T_s)$  is the notch filter parameter with  $T_s$  the signal sampling period.
- $0 < r < 1$  the notch bandwidth

Cascaded ANF  $\prod_{i=1}^p (H_i(z))$  with  $i \in [1;p]$  and  $i \neq j$ , when they have converged, will remove all sinusoidal components except the one of frequency  $f_j$ . Consequently, the remaining signal  $\tilde{y}_k^j$  is written:

$$\tilde{y}_k^j = \prod_{\substack{i=1 \\ i \neq j}}^p \frac{1 + a_i q^{-1} + q^{-2}}{1 + r \cdot a_i q^{-1} + r^2 q^{-2}} \cdot y_k \quad (30)$$

Filtering of the remaining signal  $\tilde{y}_k^j$  with a last notch filter  $H_j$  will give us the prediction error of  $f_j$  estimation:

$$\varepsilon_k^j = H_j(q^{-1})\tilde{y}_k^j = \frac{1 + a_j q^{-1} + q^{-2}}{1 + r \cdot a_j q^{-1} + r^2 q^{-2}} \tilde{y}_k^j \quad (31)$$

Minimization of the output prediction error  $\varepsilon_k^j$  will lead to estimate the error gradient:

$$\psi_{k-1}^j = -\frac{d\varepsilon_k^j}{da_j} = \frac{(1-r)(1-rq^{-2})}{(1+r \cdot a_j q^{-1} + r^2 q^{-2})^2} \cdot \tilde{y}_{k-1}^j \quad (32)$$

Real time implementation of the frequency estimation leads to use the following Recursive Maximum Likelihood algorithm:

$$\begin{cases} \text{for } j = 1, \dots, p \text{ do} \\ \hat{a}_k^j = \hat{a}_{k-1}^j + F_{k-1}^j \cdot \psi_{k-1}^j \cdot \varepsilon_k^j \\ F_k^j = \frac{F_{k-1}^j}{(\lambda + \psi_{k-1}^j \cdot F_{k-1}^j \cdot \psi_{k-1}^j)} \end{cases} \quad (33)$$

where:

- $\hat{a}_k^j = -2\cos(2\pi \cdot \hat{f}_j(k) \cdot T_s)$
- $F_k^j$  is the adaptation gain
- $0 < \lambda < 1$  is the forgetting factor

Notch filter second order cells are applied in a cascaded way. This implementation is showed on figure 3. In a recursive manner, current cell input is the output prediction error of the previous ones. The filters bandwidth  $r_k$  is time varying from  $r_0$  to  $r_f$  according to the following expression:  $r_k = r_d \cdot r_{k-1} + (1 - r_d) \cdot r_f$ . The convergence and performance of frequency estimation using ANF are developed in [16].

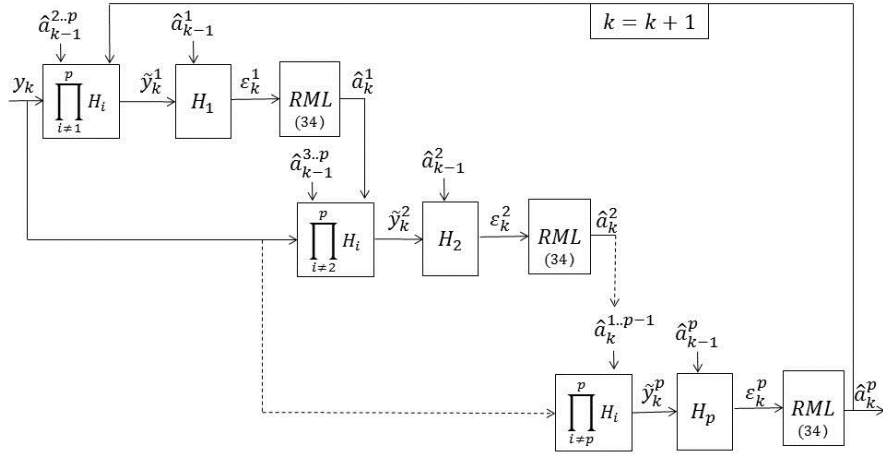

Fig. 3: Frequencies estimation stage of ANF algorithm

#### Amplitudes and phases estimation:

When the component frequencies  $f_i$  are known we can use a Weighted Recursive Least Squares (WRLS) to estimate amplitude and phase of each component. The signal defined in 28 can be decomposed in a Fourier basis as follows:

$$y_k = \sum_{i=1}^p [g_i(k) \cdot \cos(2\pi f_i T_s \cdot k) + h_i(k) \cdot \sin(2\pi f_i T_s \cdot k)] + v_k \quad (34)$$

where  $C_i = \sqrt{g_i^2 + h_i^2}$  is amplitude of the component frequency  $f_i$  and  $\beta_i$  its phase ( $\tan(\beta_i) = g_i/h_i$ ).

The parameter vector  $\hat{\theta}_k$  and regression vector  $\Phi_k$  are defined as follows:

$$\begin{cases} \hat{\theta}_k = [g_1 \ g_2 \ \dots \ g_p \ h_1 \ h_2 \ \dots \ h_p]^T \text{ and } \Phi_k = [C, S]^T \text{ with} \\ C = [\text{Cos}(2\pi f_1.T_s.k) \ \dots \ \text{Cos}(2\pi f_p.T_s.k)] \\ S = [\text{Sin}(2\pi f_1.T_s.k) \ \dots \ \text{Sin}(2\pi f_p.T_s.k)] \end{cases} \quad (35)$$

The Fourier parameters  $g_i$  and  $h_i$  are estimated using the WRLS:

$$\begin{cases} \varepsilon_k^0 = y_k - \hat{\theta}_{k-1}^T \cdot \Phi_k \\ G_k = \frac{1}{\lambda_0} \left( G_{k-1} - \frac{G_{k-1} \Phi_k^T \Phi_k G_{k-1}}{\lambda_0 + \Phi_k^T G_{k-1} \Phi_k} \right) \\ \hat{\theta}_k = \hat{\theta}_{k-1} + G_k \cdot \Phi_k \cdot \varepsilon_k^0 \end{cases} \quad (36)$$

where  $\varepsilon_k^0$  is the a priori prediction error,  $G_k$  the adaptation gain and  $\lambda_0$  the exponential forgetting factor typically chosen between 0.98 and 0.995.

### Time Prediction at instant k+d

The prediction of  $y_{k+d}$  uses the last available parameters ( $g_i(k), h_i(k), f_i(k)$ ) identified at instant k. As for ARMA and MCA method, during the prediction period, we keep the parameters estimated at time k.

$$y_{k+d} = \sum_{i=1}^p [g_i(k) \cdot \text{Cos}[2\pi f_i(k) \cdot T_s \cdot (k+d)] + h_i(k) \cdot \text{Sin}[2\pi f_i(k) \cdot T_s \cdot (k+d)]] \quad (37)$$

## 4 Application and Comparative Analysis

### 4.1 Prediction methods comparison on experimental data

In order to compare the performance of the three prediction methods, we propose to test the algorithms on a pitch angle measurement signal. This attitude signal was recorded using an IMU, on a large ship navigating in North sea.

We present here the results of the pitch angle prediction with varying horizon from 0 to 1 second (figures 4, 5 and 6) and from 0 to 5 seconds (figures 7, 8 and 9). The predictions are generated on windows of 1s (respectively 5s) successively distributed on time range [500s 600s]. These windows contain predictions with horizon ranging from 0 to 1s (respectively 5s) and are sampled at 10Hz (respectively 5Hz). Consequently, predictions on 1s windows (respectively 5s) are ranging from 0 to 10 steps ahead (respectively 25 steps). Each prediction uses all the past data available until the start of the prediction window. For example, with windows of 5s, the prediction signal starts



at 500s and uses 0-500s past data, the second prediction signal starts at 505s and uses 0-505s past data, etc.. Note that the overall prediction signal (in red) will be discontinued at each window extremity because the last point of a window corresponds to 10 steps ahead prediction (respectively 25 steps), whereas the first point of the next window corresponds to 0 step ahead prediction. Prediction is presented this way in order to observe how the predictor sees the next future second (or 5 seconds).

We selected the signal time range [500s 600s] because in this data region the amplitudes spectrum are time varying and exhibit some non sinusoidal parts that we qualify as "accidents" (512s - 516s and 580s - 585s). These accidents can be originated either by a modification of local sea state due to wind gust or ocean floor topography. In our study, they allow to test the robustness of our prediction methods.

#### 4.1.1 Methods settings

**ARMA:** Orders of ARMA model ( $n_a$  and  $n_c$ ) are selected according to Bayesian Information Criterion (BIC) applied on past data. They usually range between 10 and 30 parameters ( $n_a + n_c$ ). We choose data window of 500s length on which is applied a forgetting coefficient  $\lambda = 0.99$ . Pitch angle signal is re-sampled at 10Hz. Consequently a 5 seconds prediction horizon corresponds to 50 sampling points step ahead prediction.

**MCA:** For the presented MCA results, the signal is also re-sampled at 10Hz. Past data is cut using a 50 seconds window ( $N = 500$ ). Eigenvalues of the auto-correlation matrix  $R_y$  lower than 2% of the total energy of  $\Delta$  are selected.  $n_1$  and  $P$  are chosen according to remarks given in implementation paragraph of section 3.2. note that this method is not recursive.

**ANF:** According to the pitch angle spectrum versus time, we distinguish 3 main frequencies, we choose  $p = 3$  for the ANF frequencies estimation stage. The parameters estimates  $\hat{a}_0^j$  are set to zero at the beginning of each prediction window (15s). For ANF bandwidths,  $r_0$  is typically lower than 0.5 and  $r_f$  is chosen so that the poles of  $H_i$  are as close as possible from the unit circle. The initial value of the adaptation gain is set to a large value, typically  $G_0 = 100$ . The forgetting factor  $\lambda_0$  is set to 0.99. The parameters vector  $\hat{\theta}(0)$  is initially set to 0.

#### 4.1.2 Prediction results

On figures 4, 5 and 6 corresponding to prediction horizon ranging from 0 to 1 second, we observe that the prediction error is relatively low with better performance for ANF method. However, brutal signal damping (accident at 512s, 562s and 581s) are not anticipated by any methods. For example, at

581s, the predictors think that the signal will keep its sinusoidal form and will continue to decrease. However the real signal starts to rise at this moment.

On figures 7, 8 and 9 corresponding to prediction horizon ranging from 0 to 5 seconds, we observe that the phase is generally respected expect for signal accidents (512s and 582s).

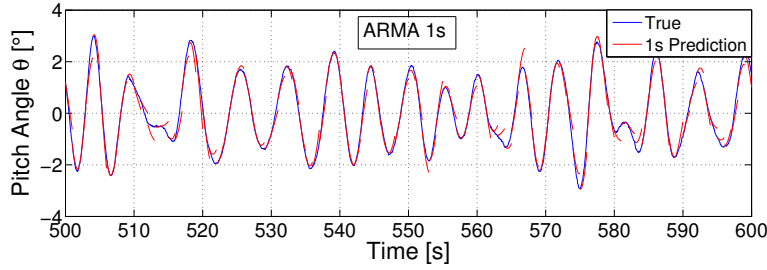

Fig. 4: Prediction with horizon from 0 to 1s using an ARMA model

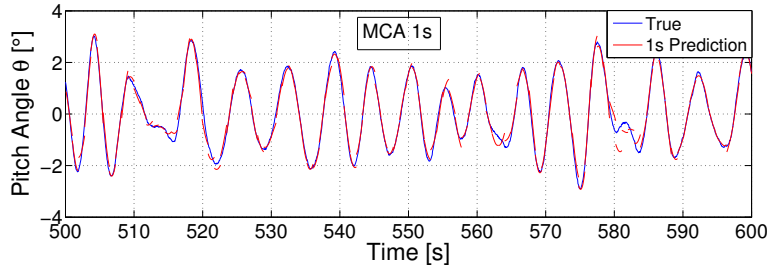

Fig. 5: Prediction with horizon from 0 to 1s using Minor Component Analysis

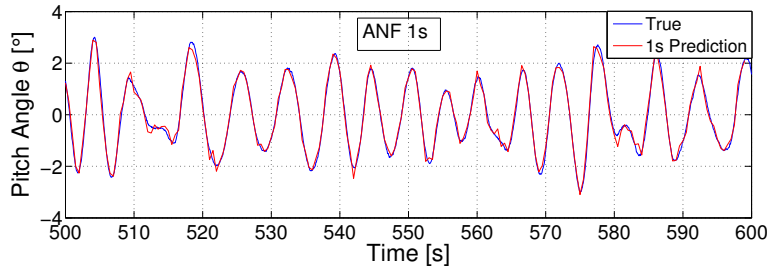

Fig. 6: Prediction with horizon from 0 to 1s using Adaptive Notch Filters

## 4.2 Comparative Analysis

According to the prediction method used, restrictive hypothesis on the signal is applied. ANF prediction method requires the signal to have a narrow band

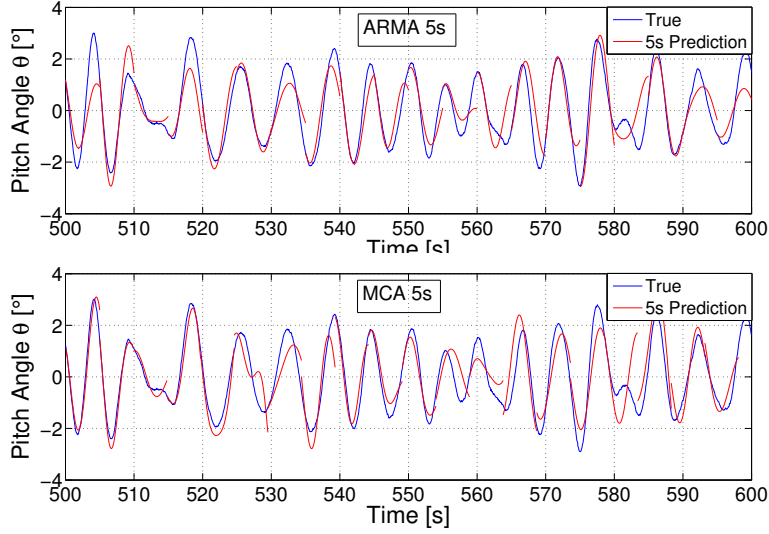

Fig. 8: Prediction with horizon from 0 to 5s using Minor Component Analysis

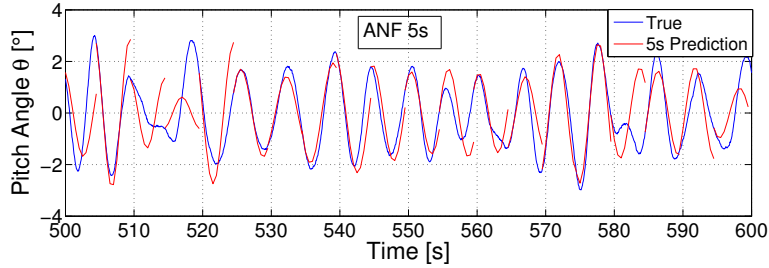

Fig. 9: Prediction with horizon from 0 to 5s using Adaptive Notch Filters

spectrum (which is our case) whereas ARMA and MCA methods have no restrictions. MCA is an off line method and assume the signal to be stationary. The two other methods can be applied recursively and accept slow time variations of the signal features.

The overall complexity of the prediction algorithm has to be considered for real time and on board implementation. Recursive form of ARMA and ANF methods give then a significant advantage compared to MCA method which needs to compute the inverse of a  $P \times P$  matrix at each prediction generation. The complexity is given in number of operation (flops) per time iteration. ARMA method complexity is  $O((n_a + n_c)^2)$  with  $n_a$  and  $n_c$  between 30 and 40. The complexity of MCA method is  $O(P^3)$  with  $P \approx 300$ . Lowest complexity  $O(p^2)$  is reached by ANF method with  $p$  varying from 3 to 6.

Prediction error is another important criterion that should be studied. For comparison we use the normalized mean squared error of 5s prediction of pitch angle measurement presented in part 4.1. MCA method gives the low-

est error with 2.69%.

Tracking of varying frequencies and amplitude of the signal is crucial for ship motion prediction. A study with synthetic signals (not presented here) show that ARMA and ANF methods are capable to adapt their model parameters faster than MCA method.

A summary of the comparative analysis is presented on table 1.

	Hypothesis	Complexity	Error	Tracking capability	Advantages	Drawbacks
ARMA	None	+	9.12%	+	Software implementation	Order selection ( $n_a$ & $n_b$ )
MCA	None	-	2.69%	-	Low error	High complexity & Off line
ANF	Narrow band	++	9.53 %	++ Good for nonstationary signals	Low complexity	Choice of penalties constraints ( $r, \lambda$ )

Table 1: Comparative Analysis of Prediction Methods

MCA prediction method is not well suited for online estimation, further it is more advisable to develop a recursive algorithm. ARMA and ANF methods provide similar performance regarding prediction error for tracking capability. When the signals are narrow band the ANF perform quite better. However the number of parameter to estimate for ANF ( $p$ ) is significantly lower than for ARMA method (between 30 and 40). This leads to very faster convergence of the prediction error. ANF method will consequently be favoured for ship motion prediction. We have used cascaded ANF and a two stages structure, to estimate also the amplitudes and phase. In future work we will investigate more simpler implementation, despite that the other method are much more complex for implementation.

## 5 Conclusion

Several prediction methods have been investigated for comparison. A new prediction method has been presented for motion of ship navigating through sea swell and compared to ARMA and MCA methods. The main interest of ANF method is to estimate efficiently time varying frequencies, amplitude and phases of sinusoidal signals. ANF algorithm shows good robustness to time varying perturbation on the ship. Real time implementation of this algorithm on board is feasible and easier thanks to its recursive form and low number of parameters. ANF and ARMA methods give similar results but ANF shows better tracking capability and lower computation load. It

has been shown that prediction error on a horizon up to 5 seconds may be satisfactory for use in helicopter guidance during hoist operation.

Future work will focus on building a complete state observer of the ship via image analysis from a camera mounted on helicopter. Indeed, ships that have IMU equipment broadcasting their motion data are not common. Then the development of helicopter control laws for SAR missions will be carried out. The prediction of wind perturbation using ANF will be also considered.

## References

1. N. K. M'Sirdi, H. R. Tjokronegoro, and I. D. Landau, "An rml algorithm for retrieval of sinusoids with cascaded notch filters," in *ICASSP-88., International Conference on Acoustics, Speech, and Signal Processing*, Apr 1988, pp. 2484–2487 vol.4.
2. N. K. M'Sirdi, M. Antoine, and A. Naamane, "Adaptive notch filters for prediction of narrow band signals," in *ICSC 2018*, Valencia, Spain, October 2018.
3. T.-B. Airimitoiaie, "Robust Design and Tuning of Active Vibration Control Systems," Theses, Université de Grenoble, Jun. 2012.
4. I. D. Landau, M. Alma, A. Constantinescu, J. J. Martinez, and M. NoeÁl, "Adaptive regulation rejection of unknown multiple narrow band disturbances (a review on algorithms and applications)," *Control Engineering Practice*, vol. 19, no. 10, pp. 1168 – 1181, 2011.
5. I. D. Landau, A. C. Silva, T.-B. Airimitoiaie, G. Buche, and M. NoeÁl, "Benchmark on adaptive regulation rejection of unknown/time-varying multiple narrow band disturbances," *European Journal of Control*, vol. 19, no. 4, pp. 237 – 252, 2013, benchmark on Adaptive Regulation: Rejection of unknown/time-varying multiple narrow band disturbances.
6. S. D. Manley, "Sea loads on ships and offshore structures," in *Annual meeting of The Society of Naval Architects and Marine Engineers New York, 1953*, ser. On the Motions of Ships in Confused Seas. Cambridge University Press, 1953.
7. M. Triantafyllou, M. Bodson, and M. Athans, "Real time estimation of ship motions using kalman filtering techniques," *IEEE Journal of Oceanic Engineering*, vol. 8, no. 1, pp. 9–20, January 1983.
8. D. Lainiotis, C. Charalampous, P. Giannakopoulos, and S. Katsikas, *Real Time Ship Motion Estimation*, 11 1992.
9. X. Yang, "Displacement motion prediction of a landing deck for recovery operations of rotary uavs," *International Journal of Control, Automation and Systems*, 2013.
10. I. Yumori, "Real time prediction of ship response to ocean waves using time series analysis," in *OCEANS 81*, Sept 1981.
11. G. Zhao, R. Xu, and C. Kwan, "Ship-motion prediction: algorithms and simulation results," *2004 IEEE International Conference on Acoustics, Speech, and Signal Processing*, vol. 5, pp. V–125, 2004.
12. "Real-time long-term prediction of ship motion for fire control applications," *Electronics Letters*, vol. 42, no. 18, pp. 1020 – 1021, 2006.
13. L. Ljung, *System Identification: Theory for the User*. Upper Saddle River, NJ, USA: Prentice-Hall, Inc., 1986.
14. R. Kashyap, "Inconsistency of the aic rule for estimating the order of autoregressive models," *IEEE Transactions on Automatic Control*, vol. 25, no. 5, pp. 996–998, October 1980.
15. G. Schwarz, "Estimating the dimension of a model," *Ann. Statist.*, vol. 6, no. 2, pp. 461–464, 03 1978.

16. A. N. Nacer K. M'Sirdi, Antoine Monneau, "Adaptative notch filters for prediction of narrow band signals," *2018 International Conference on Systems and Control*, 2018.