



HAL
open science

Data Analysis-Based Gas Identification with a Single Metal Oxide Sensor Operating in Dynamic Temperature Regime

Nicolas Morati, Thierry Contaret, Jean-Luc Seguin, Marc Bendahan,
Oussama Djedidi, Mohand Djeziri

► **To cite this version:**

Nicolas Morati, Thierry Contaret, Jean-Luc Seguin, Marc Bendahan, Oussama Djedidi, et al.. Data Analysis-Based Gas Identification with a Single Metal Oxide Sensor Operating in Dynamic Temperature Regime. ALLSENSORS 2020, The Fifth International Conference on Advances in Sensors, Actuators, Metering and Sensing, Nov 2019, Valencia, Spain. pp.20-23. hal-02575436

HAL Id: hal-02575436

<https://amu.hal.science/hal-02575436v1>

Submitted on 14 May 2020

HAL is a multi-disciplinary open access archive for the deposit and dissemination of scientific research documents, whether they are published or not. The documents may come from teaching and research institutions in France or abroad, or from public or private research centers.

L'archive ouverte pluridisciplinaire **HAL**, est destinée au dépôt et à la diffusion de documents scientifiques de niveau recherche, publiés ou non, émanant des établissements d'enseignement et de recherche français ou étrangers, des laboratoires publics ou privés.

Data Analysis-Based Gas Identification with a Single Metal Oxide Sensor Operating in Dynamic Temperature Regime

Nicolas Morati, Thierry Contaret, Jean-Luc Seguin
and Marc Bendahan
Aix-Marseille Univ, Univ Toulon, CNRS, IM2NP
Marseille, 13397, France
e-mails: nicolas.morati@im2np.fr;
thierry.contaret@im2np.fr; jean-luc.seguin@im2np.fr;
marc.bendahan@im2np.fr

Oussama Djedidi and Mohand Djeziri
Aix-Marseille Univ, Univ Toulon, CNRS, LIS
Marseille, 13397, France
e-mails: oussama.djedidi@lis-lab.fr; mohand.djeziri@lis-
lab.fr

Abstract—This paper deals with a preliminary evaluation of a new data-driven approach aiming to discriminate several gases in a gas mixture, with a single Metal Oxide (MOX) sensor, under real conditions of use, i.e. in the permanent presence of a gas concentration. This method relies on a database obtained using temperature modulation of the sensor, for fixed gas concentrations. The database is increased by extracting the temporal attributes of the signal, and then reduced using principal component analysis to extract only useful information. Gas discrimination is achieved by the online projection of measurements in the principal space consisting of the two main components. Experimental results obtained on a test bench show the effectiveness of the proposed approach: carbon monoxide, ozone and nitrogen dioxide are clearly discriminated using one single MOX gas micro sensor.

Keywords—MOX gas sensor; temperature modulation; temporal attributes; multivariate analysis; gas discrimination.

I. INTRODUCTION

The quality of outdoor and indoor air has become a very important health, societal and political issue. The health issue is recognized by institutions (World Health Organization in the leading position) and, for populations, air quality has become a major concern. The most harmful pollutant gases to health include carbon monoxide (CO), ozone (O₃), nitrogen dioxide (NO₂) and sulphur dioxide (SO₂). The variety of pollutants being large and the harmful concentrations for health being very low, it has become imperative to design detection systems that are both highly sensitive and highly selective. Today, only measurements by on-site sampling and laboratory analysis can meet these requirements, but remain expensive and incompatible with real-time monitoring. The development of highly sensitive, reliable, portable and low-cost detection systems is still limited because they are not sufficiently selective. Metal oxide (MOX) gas sensors are readily available and widely used in portable and low-cost gas monitoring devices because of their high sensitivity, stability and attractive lifetime. However, this type of gas sensor suffers from an inherent lack of selectivity, since the gas detection mechanism is rather nonspecific and more or less any type of reducing or oxidizing gas is detected. To overcome this low

selectivity, MOX type gas sensors are most often assembled to form an electronic nose. The electronic nose is a complex system consisting of a set of multiple sensors, an information processing unit, software with digital pattern recognition algorithms, and databases with reference libraries [1][2]. The challenges of miniaturization and reduction of energy consumption involve minimizing the number of sensors. For this purpose, it is necessary to increase the amount of information provided by one sensor using advanced measurements, such as temperature modulation or fluctuation enhanced sensing [3]-[5].

The purpose of this study is to provide gases identification methods that can discriminate several gases with a single MOX sensor, under real conditions of use, i.e. in the permanent presence of a gas concentration. As a first step of the study, we report here on the evaluation of a new method based on temperature modulation of the sensor and data treatment using temporal attributes of the sensor response. The used methodology and the experimental set-up are described in Sections II and III, respectively. In Section IV, we present the results for three air quality gases (O₃, NO₂ and CO). Then, the capability of discriminating gases was evaluated using Principal Component Analysis (PCA). We conclude the work in Section V.

II. METHODOLOGY

The methodology is summarized in Figure 1. First, a database is created by measuring the sensor's resistance when modulating its operating temperature for fixed gas concentrations. Then, the database is increased by extracting the temporal attributes of the obtained signal, and then reduced using principal component analysis to extract only useful information. Gas discrimination is achieved by the online projection of measurements in the principal space consisting of the two main components. PCA is a robust and unsupervised model recognition approach commonly used for multivariate data analysis. It is a statistical procedure that converts a set of observations of possibly correlated variables into a new set of values called principal components. PCA has proven its effectiveness in many areas of application [6]-[8], including electronic noses [2].

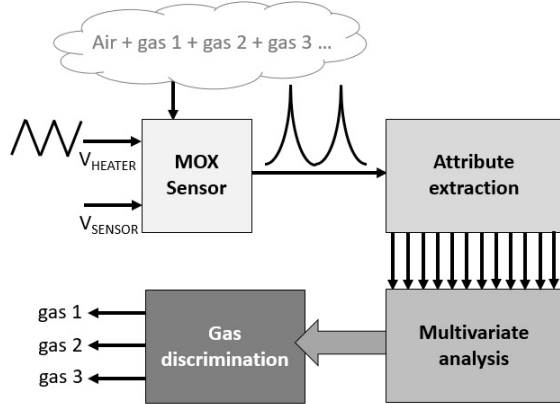

Figure 1. Summary of the used methodology.

III. EXPERIMENTS

In order to obtain a large amount of data, we have chosen to operate our microsensor in variable temperature mode: the heating voltage of the sensitive layer is varied triangularly between two extreme values with a very small voltage step. The maximum value of the triangular signal will correspond to the optimal detection temperature for the targeted gases. The sensor must have a transducer with a fast and efficient heating system. The sensor used in this study comes from a new technology developed by the IM2NP laboratory and the NANOZ-SAS company [9]. The sensor device has two distinct heaters and four detection zones offering several operating modes in single or multi-sensors. Figure 2 shows a picture of the sensor indicating the contact pads for the four sensors, the two heaters and the ground.

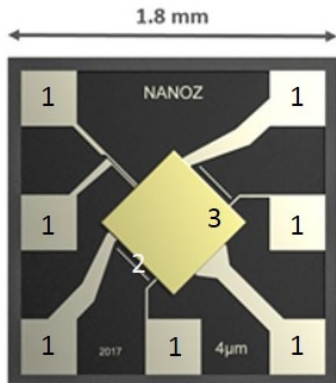

Figure 2. IM2NP - NANOZ sensor device [9]: 1- Contact pads; 2- SiO₂ membrane; 3- WO₃ sensing layer covering the two heaters and the four detection zones. The transducer design showing the four sensitive zones and the two heaters is hidden for copyright reasons.

One of the innovations of our sensor is that the heating element is located on the same plane as the sensing element, on a SiO₂ membrane. The heaters and sensing electrodes were first realized in a sputtered platinum thin film using classical photolithography. Then, the WO₃ thin sensing layer was deposited by reactive magnetron radio-frequency sputtering and annealed at a temperature well above the

operating temperature during two hours to improve its nanocrystallization and stability. As part of this study, we chose to operate in single sensor mode according to the diagram in Figure 3. We note R_{S1} , R_{S2} , R_{S3} and R_{S4} the sensor resistances of the four detection zones, and R_{H1} and R_{H2} the resistances of the two heaters.

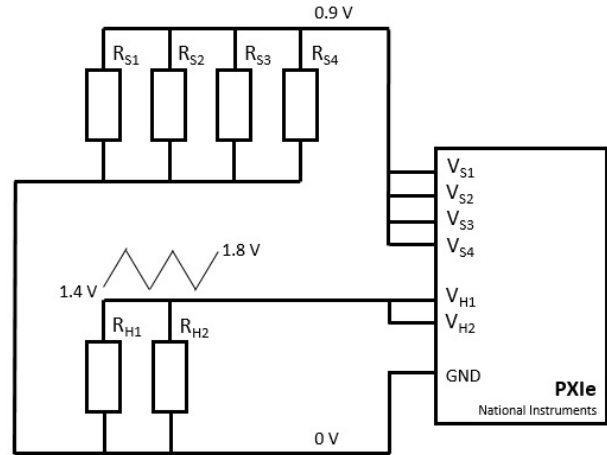

Figure 3. Electrical configuration of the sensor. V_{S1} , V_{S2} , V_{S3} and V_{S4} are the voltage across sensor resistances R_{S1} , R_{S2} , R_{S3} and R_{S4} , respectively. V_{H1} and V_{H2} are the voltage across heating resistances R_{H1} and R_{H2} , respectively.

The four sensors are biased at 0.9V using National Instrument PXIe 4140 source meter. The two integrated heaters are powered by a staircase waveform of amplitude 0.4V centered on 1.6V, as illustrated in Figure 4. The voltage value 1.8V allows to heat the sensitive layer at a temperature of 252 °C. This temperature corresponds to an optimal detection of the tested gases. The voltage of 1.4V corresponds to a temperature of 199 °C, which is the limit of detection. The staircase waveform is generated by programming the PXIe 4113 voltage source. The variation between each step is 10mV and the duration of each step is 1s. The configuration and control of the PXIe devices are performed with our developed LabVIEW application.

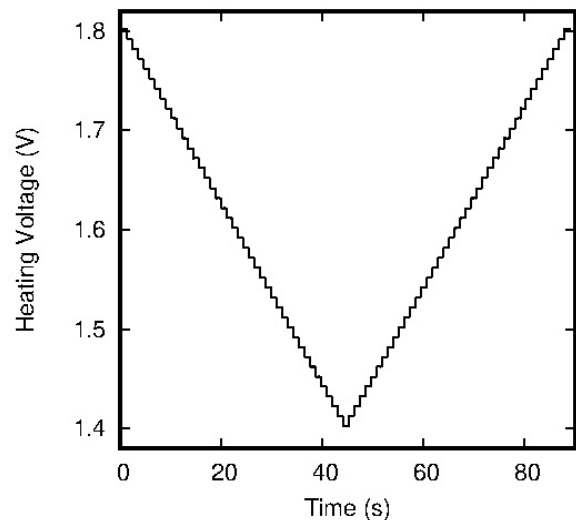

Figure 4. A period of the voltage applied to the heaters.

The sensor device is placed in a 3D-printed prototype test chamber developed in the IM2NP laboratory. This chamber enhances the gas flow hydrodynamics, in particular the gas concentration homogeneity and the reduction of flow recirculation and dead volumes [10]. To generate gas concentrations and measure sensor responses, we developed an experimental test bench shown in Figure 5. The dilution system provides a concentration range of 200 ppb to 16 ppm in order to test the limit thresholds of the tested pollutants. Mixed gases are admitted and evacuated from the test chamber via distribution valves.

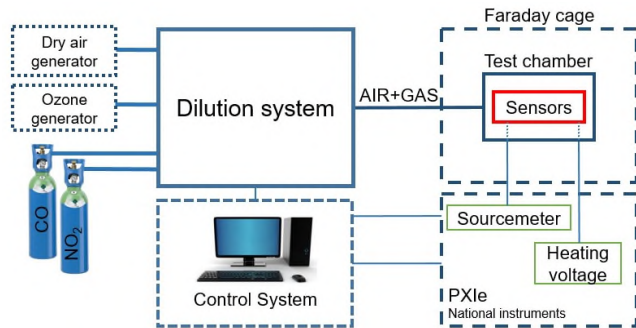

Figure 5. Experimental set up for microsensor characterization.

IV. RESULTS

This work is focused on the monitoring of air quality using metal oxide sensors. The microsensor has been exposed to three gases related to the air quality: ozone (O₃), nitrogen dioxide (NO₂) and carbon monoxide (CO). For each gas, we have chosen three concentrations close to the sanitary thresholds (see Table I). The WO₃ sensitive thin film deposited on our specific transducer enables to detect all these concentrations.

TABLE I. VARIOUS GASES CONCENTRATION USED IN EXPERIMENTAL SET UP.

Gases	Concentrations		
	C1	C2	C3
NO ₂	200 ppb	400 ppb	800 ppb
O ₃	80 ppb	110 ppb	160 ppb
CO	2 ppm	8 ppm	16 ppm

For each gas concentration, we proceeded with the following protocol:

- constant exposure of the sensor to a given gas concentration;
- biasing sensors at $V_S = V_{S1} = V_{S2} = V_{S3} = V_{S4} = 0.9V$.
- heating of the sensitive layer at the optimum detection temperature ($V_H = V_{H1} = V_{H2} = 1.8V$) during 5 minutes;
- heating of the sensitive layer using staircase waveform during four periods of the signal described in Figure 4;
- return to the optimal detection temperature.

In Figure 6, we present an example of the response of the sensor (bottom curve) to the staircase waveform in thermal modulation (top curve) for an ozone concentration. We have obtained similar responses for all gases, but all responses have different signal parameters. The proposed gas discrimination method is based on the characterization of the temporal attributes of the signal, including certain statistical parameters. Indeed, these mathematical moments enable to characterize a distribution and are interesting to take into account when studying transient phenomena. In our case, they can characterize mechanisms related to gases adsorption-desorption processes on the surface of the sensitive layer.

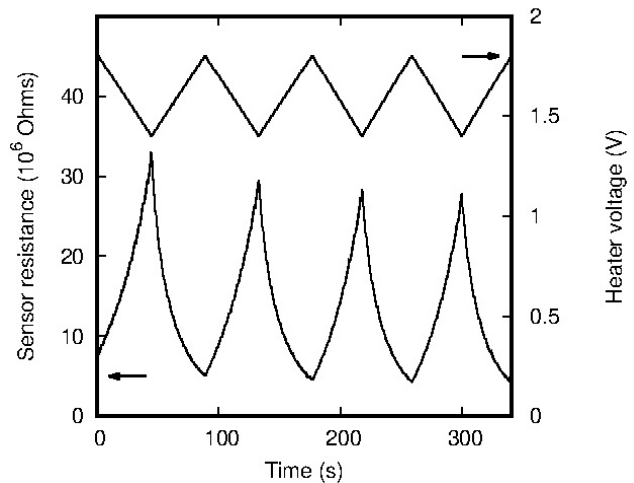

Figure 6. Example of sensor response (bottom curve) to triangular temperature variation (top curve) for 160 ppb of O₃.

To obtain a sufficient number of variables and to constitute a statistics database, we calculated the following temporal attributes for each gas response:

- peak to peak value.
- mean value.
- the root mean square value.
- the third standardized moment called skewness.
- the fourth standardized moment called kurtosis.
- the crest factor.
- the shape factor.
- the variance.

From the sets of calculated parameters of each gas concentration, we have evaluated the possibility of identifying the three studied gases using Principal Component Analysis. In PCA, the score diagrams show the relationships between the analyzed variables (different concentrations of the three gases in our studies). PCA has been performed using the Pearson matrix calculation. The PCA variables are the parameters of the temporal attributes. All PCA variables have a significant length in the PC1 / PC2 plane. The scores graph of the first two principal components (PC1 and PC2) is given in Figure 7. We clearly observe three groups of data. Each group corresponds to a gas. A first separation can be made according to the component PC1.

The corresponding CO data have a strongly positive PC1, while the NO₂ and O₃ have negative PC1 values.

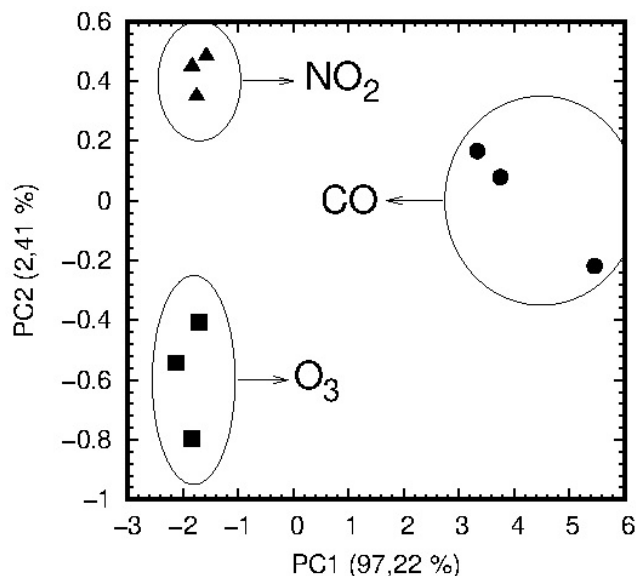

Figure 7. PCA scores plot.

The component PC2 makes it possible to separate these two gases. Indeed, the values of O₃ have a negative value of PC2. Conversely, the values for NO₂ have a positive value on PC2. The results of the PCA show that a clear distinction is possible between the three studied gases. Our results are consistent with other studies which have shown that the staircase waveform to modulate the temperature of sensing layer was the most effective to distinguish several gases with one single sensor [4].

V. CONCLUSION AND FUTURE WORK

In this paper, we have presented a preliminary evaluation of a new gases identification method aiming to discriminate several gases with a single MOX sensor, under real conditions of use, i.e. in the permanent presence of a gas concentration. This method is based on temperature modulation of the sensing layer of the sensor, for a fixed gas concentration, followed by data treatment using temporal attributes of the sensor response. Finally, the PCA multivariable analysis method, applied to all data, has shown that it is possible to discriminate NO₂, O₃ and CO using one single MOX sensor.

After this preliminary step, more work is in progress in order to:

- study whether the number of temporal attributes can be reduced;
- increase the database by adding more gas concentrations and mixing the gases with each other and with humidity;
- apply and test classification algorithms such as Support Vector Machines, k Nearest Neighbors or Neural Networks.

ACKNOWLEDGMENT

Nicolas Morati would like to thank Région Sud of France and Nanoz SAS for financial support. We also thank Tomas Fiorido for his technical support throughout this work.

REFERENCES

- [1] J. Gutiérrez and M.C. Horrillo, "Advances in artificial olfaction: sensors and applications", *Talanta*, vol. 124, pp. 95–105, 2014.
- [2] W. Hu et al., "Electronic Noses: From Advanced Materials to Sensors Aided with Data Processing". *Advanced Materials Technologies*, vol. 4, 2019, 1800488. <https://doi.org/10.1002/admt.201800488>.
- [3] J. M. Smulko et al., "New approaches for improving selectivity and sensitivity of resistive gas sensors: a review." *Sensor Review*, vol. 35, pp. 340–347, 2015. <https://doi.org/10.1108/SR-12-2014-0747>
- [4] S. M. Hosseini-Golgo, F. Salimi, A. Saberkari, and S. Rahbarpour, "Comparison of information content of temporal response of chemoresistive gas sensor under three different temperature modulation regimes for gas detection of different feature reduction methods." *J. Phys.: Conf. Ser.* 939, 2017, 012005. <https://doi.org/10.1088/1742-6596/939/1/012005>
- [5] S. Gomri et al., "A Noise Spectroscopy-Based Features Extraction Method to Detect Two Gases Using One Single MOX Sensor", *IEEE Sensors Journal*, Vol.19, No.20, pp. 9063-9070, 2019, DOI: 10.1109/JSEN.2019.2923699
- [6] M. A. Djeziri, S. Benmoussa, and R. Sanshez. "Hybrid method for remaining useful life prediction in wind turbine systems." *Renewable Energy*, vol. 116, pp. 173-187, 2018.
- [7] L. Nguyen, M. A. Djeziri, B. Ananou, M. Ouladsine, and J. Pinaton. "Fault prognosis for batch production based on percentile measure and gamma process: Application to semiconductor manufacturing". in *Journal of Process Control*, Vol. 48, pp. 72-80, 2016.
- [8] L. Nguyen, M. A. Djeziri, B. Ananou, M. Ouladsine, and J. Pinaton. "Health Indicator Extraction for Fault Prognosis in Discrete Manufacturing Processes", *IEEE Transaction on Semiconductor Manufacturing*, vol.28, no. 3, pp. 306-317, 2015.
- [9] K. Aguir, M. Bendahan, and V. Laithier, "Heated sensitive layer gas sensor" patent N°FR 13 59494, 2013, international extension in 2016, US20160238548
- [10] F. E. Annanouch et al., "Hydrodynamic evaluation of gas testing chamber: Simulation, experiment", *Sensors & Actuators: B. Chemical*, vol. 290 pp. 598–606, 2019 DOI: 10.1016/j.snb.2019.04.023