



HAL
open science

Detection and Estimation of Helicopters Vibrations by Adaptive Notch Filters

Antoine Monneau, Nacer M'Sirdi, Sébastien Mavromatis, Guillaume Varra,
Marc Salesse, Jean Sequeira

► **To cite this version:**

Antoine Monneau, Nacer M'Sirdi, Sébastien Mavromatis, Guillaume Varra, Marc Salesse, et al.. Detection and Estimation of Helicopters Vibrations by Adaptive Notch Filters. 17th International Conference on Informatics in Control, Automation and Robotics, Jul 2020, Online Streaming, France. 10.5220/0009910302010207 . hal-02936935

HAL Id: hal-02936935

<https://amu.hal.science/hal-02936935v1>

Submitted on 11 Sep 2020

HAL is a multi-disciplinary open access archive for the deposit and dissemination of scientific research documents, whether they are published or not. The documents may come from teaching and research institutions in France or abroad, or from public or private research centers.

L'archive ouverte pluridisciplinaire **HAL**, est destinée au dépôt et à la diffusion de documents scientifiques de niveau recherche, publiés ou non, émanant des établissements d'enseignement et de recherche français ou étrangers, des laboratoires publics ou privés.



Distributed under a Creative Commons Attribution - NonCommercial - NoDerivatives 4.0 International License

Detection and Estimation of Helicopters Vibrations by Adaptive Notch Filters*

Antoine Monneau^{1,2}, Nacer K. M'Sirdi¹ ^a, Sébastien Mavromatis¹, Guillaume Varra², Marc Salesse² and Jean Sequeira¹

¹Aix Marseille Université, Université de Toulon, CNRS, LIS, LIS UMR CNRS 7020, Marseille, France

²Airbus Helicopters, Marignane, France

Keywords: Adaptive Spectral Analysis, Vibration detection, Adaptive Notch Filters, Aerospace Systems.

Abstract: This paper addresses online vibration detection in helicopters using Adaptive Filters. Adaptive Notch Filters (ANF) are used to estimate and track the time varying frequencies of the vibrations. We estimate and track the amplitudes and phases of time varying frequencies of the vibrations. This allows the detection of abnormal oscillations in the helicopter flight to keep control of the aircraft. In the application presented, we show the detection of severe vibrations that occurred during a helicopter flight test. This proves the effectiveness of proposed ANF to track and reject narrow band perturbations.

1 INTRODUCTION

1.1 Mechanical Vibrations of Helicopters

Within helicopters structure, the excitation's stresses are relatively important considering the mass of the fuselage and its flexibility. The large number of rotating parts aboard a helicopter generates vibrations that can be fed back into the flight loop by the aircraft flight control system (AFCS) (see in (NTSB, 2018)). For example, the main rotor of an Airbus H125 rotates at 390 rpm, which generates vibrations of frequency 6.5Hz and 19.5Hz within the air-frame.

When excitation go near to natural frequencies of the helicopter, this may lead to constraints in the mechanical parts and increase the vibrations. The increasing need of comfort on board helicopters lead manufacturers to develop anti-vibration systems. The consequences of vibrations aboard a helicopter can range from the discomfort of the crew to the complete destruction of the aircraft.

The last case occurred on July 6, 2016 with the first prototype of the Bell 525 Relentless. According to the US National Transportation Safety Board (NTSB), the in-flight breakup of the aircraft was

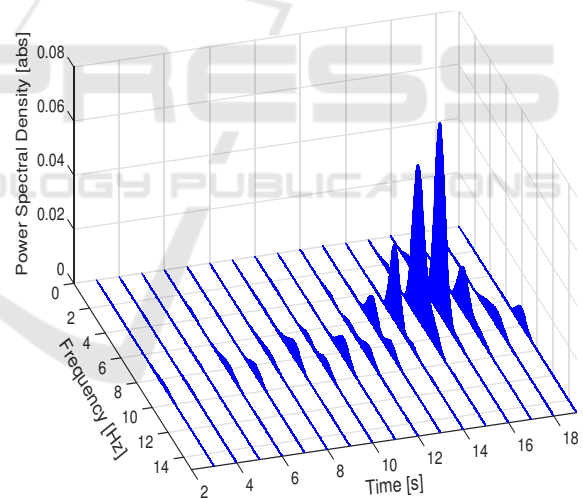



Figure 1: Power Spectral Density of the helicopter lateral acceleration $\Gamma_{Y\ pilot}$.

caused by severe vibration during a flight test at 185 kt (342 km/h), (see figure 1 (NTSB, 2018)). The vibration at 6Hz was so high in the cockpit (17mm of displacement with a vertical load factor up to 3g) that the pilots were probably unable to see the control panel nor exit the flight case. Moreover, vibrations caused unintentional vertical control inputs by the pilot that further amplified the phenomenon. A secondary feedback loop was set by the aircraft's attitude and heading reference system (AHRS). This system attempted

^a  <https://orcid.org/0000-0002-9485-6429>

*This work is supported by the SASV of the LIS (UMR CNRS 7020) and Airbus Helicopters.

to correct the airframe’s vertical vibration, however it responded to the 6Hz vibration and exacerbated rotor blades modes. While the rotor was losing speed, the excessive flapping of the blades became uncontrollable and caused the main rotor to strike the helicopter’s tail boom. This led to the crash of the aircraft.

Passive systems such as suspensions or active control systems help to decrease significantly the level of vibration. The design of such anti-vibration systems is based on mechanical models of the structure for damping oscillations near to the natural frequencies. The perturbation can be filtered based on the mechanical features (see (Krysinski and Malburet, 2007)). Passive damping and compensations can also be considered.

Sensors like accelerometers capture these vibrations and using feedback stabilization or classical controllers generates controls which contain these oscillations. As a consequence, vibrations can be amplified by the closed loop. The excitation must also be modeled, which is not an easy task for aerodynamic processes, but it can help to design active vibration compensation approaches.

In this paper we focus on fast detection and robust adaptive estimation of the perturbation, for its compensation. After a spectral analysis of the vibration (measured by accelerometers) on board helicopters, the first conclusion was that vibration can appear suddenly (see figure 1) with a narrow spectrum with and changing frequency.

1.2 Objective and Contribution

We propose the use of a narrow band signal model to describe the perturbation like in (Nehorai, 1985) or in (M’Sirdi and Landau, 1987). A notch filter can be considered for perturbation detection and filtering (see figure 2). We propose the use of a bandwidth monitored in an Adaptive Notch Filter. Then we propose an Adaptive Narrow Band Signal prediction method to perform online fast detection of the vibration frequency. This will generate an alarm and will track the time varying frequency.

This allow us to develop an efficient and very fast converging frequency estimation algorithm and adaptive filter (see figure 3).

It is worthwhile to note that the notch bandwidth depends on the parameter $0 < r < 1$. When r goes near to one the notch becomes very narrow. for estimation, we will start with r small (wide notch) and make it go to one for a narrow notch.

The third and last contribution, of this paper, is the estimation of the amplitudes and phase of the vibration in order to allow its compensation. The dis-

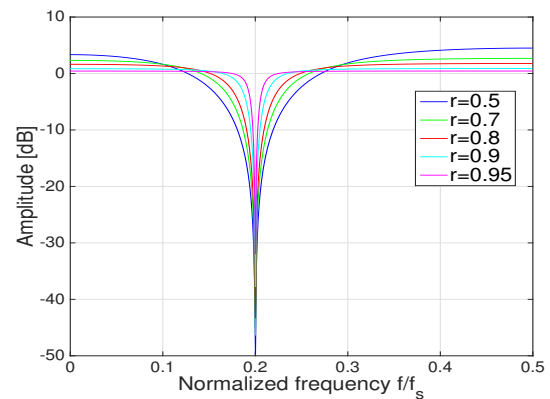

Figure 2: Frequency response of notch filter H_i centered on the normalized frequency $\frac{f}{f_s} = 0.2$ with different notch bandwidth parameter r .

crete transfer function representation do not catch the information of the signal power or amplitude. So it is necessary for detection to estimate either the signal power (output of the ANF) or the amplitude and phase of each frequency component.

This is developed assuming not only one but several frequencies in the vibrations. Note that the proposed Adaptive Notch Filters may be cascaded to detect and estimate several vibration components.

This paper is organized as follows. After this introduction, section 2 is devoted to some related previous works in literature and background definition.

In section 3, we present the use of Adaptive Notch Filters (ANF) for online frequency estimation using a recursive maximum likelihood (RML) adaptation algorithm. This is followed by a recursive least squares (RLS) estimation of the amplitudes and phases of the vibration components. Section 4 presents an application of the proposed ANF and amplitude and phases estimation (APE) method on real data acquired from an helicopter flying in critical vibration conditions. This study emphasizes the interest of using the proposed method based on ANF for online spectral estimation of vibrations and shows the effectiveness of the proposed methods.

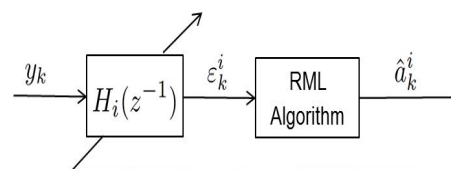

Figure 3: Frequency estimation using ANF.

2 PREVIOUS WORKS

Vibration spectral analysis is a commonly used tool in the field of industrial rotating machinery. In fact, with online processing of vibration signals, it is possible to extract the current status of the machine. In case of fault, the machine produces distinctive vibration patterns that can be compared with those of reference, thus enabling the fault detection, see (Betta et al., 2002).

The characteristic patterns of vibratory signals are often represented in the frequency domain. Most spectral signal analyzer uses the fast Fourier transform (FFT) to extract the frequency characteristics of the vibratory signal. An important limitation to the use of the FFT is its application to non stationary signals. The windowing of the signal over a fixed period makes it impossible to obtain the correlation between time and frequency components.

If the frequencies vary significantly during this period, the FFT will generate an error for building the signal spectrum. Varying frequencies are frequent on a helicopter, for example when rotors are speeding up.

The wavelet transform is a powerful alternative to the Fourier transform, which is adapted to the study of non-stationary signals. In particular, it is able to perform local spectral analysis over any time interval (zoom) without losing its frequency information. An application using continuous wavelets transform (CWT) to the study of vibrations of rotating machines is presented in (Al-Badour et al., 2011) and (Qin et al., 2011).

An auto-regressive model can be used to characterize the vibrations of a mechanical assembly. For example in (Wang and Wong, 1986), an AR filter is set to output a low residual signal during nominal operation of a helicopter transmission box. When a fault occurs, for example when a tooth fatigue crack develops, the residual signal increases because of the variation of the vibration spectrum. In fact, the AR filter is no longer centered on the nominal frequencies.

3 REAL TIME SPECTRAL ANALYSIS

Mechanical vibrations in a helicopter may results from numerous rotating parts that generate oscillatory motions. This appear when a transmission shaft is unbalanced or the pressure on the blades of the helicopter varies alternately.

3.1 Frequency Components Estimation and Tracking

The signals describing the vibrations can be seen as a sum of sinusoidal components with time varying frequencies $f^i(k)$, amplitudes $C^i(k)$ and phases $\beta^i(k)$:

$$y_k = \sum_{i=1}^n C_k^i \sin(2\pi f_k^i T_s k + \beta_k^i) \quad (1)$$

Counteracting these oscillatory signals in noise relies on accurate online detection by means of estimation of their time varying parameters. The recently proposed adaptive identification algorithm deduces the frequency estimation of narrow band signals based on Adaptive Notch Filters (ANF), see (M'Sirdi and al., 2018). Online amplitudes and phases estimation are made using Weighted Recursive Least-Squares (WRLS) algorithm on a Fourier series decomposition of the signal.

3.2 Frequencies Estimation

Adaptive Notch Filters are well known to be very efficient for extracting frequencies of signals composed of sinusoidal components, see (M'Sirdi and Landau, 1987). For example, the following second order ANF $H_i(z^{-1})$ is proposed to catch the i^{th} sinusoidal component (frequency f^i) of a given signal:

$$H_i(z^{-1}) = \frac{1 + a_i z^{-1} + z^{-2}}{1 + r a_i z^{-1} + r^2 z^{-2}} \quad (2)$$

- $a_i = -2\cos(2\pi f^i T_s)$ is the notch filter parameter with T_s as the signal sampling period
- $0 < r < 1$ the notch bandwidth parameter

Figure 2 shows the amplitude of the frequency response of H_i with different r . A small value of this parameter is associated with a large filter bandwidth whereas r close to 1 is associated with thin filtering for an accurate frequency detection.

The ANFs are cascaded when there are several sinusoidal components to be removed. The transfer function can be written $\prod_{i=1}^p H_i(z^{-1})$ with $i \in [1; p]$, for p components to estimate. When the ANFs have converged, each cell will remove one component.

When using the ANFs cascaded of equation: $\prod_{i=1, i \neq j}^p H_i(z^{-1})$ with $i \in [1; p]$ and $i \neq j$, all sinusoidal components are removed except the one of the frequency f^j .

Consequently, the remaining signal noted \tilde{y}_k^j is written:

$$\tilde{y}_k^j = \prod_{\substack{i=1 \\ i \neq j}}^p \frac{1 + a_i z^{-1} + z^{-2}}{1 + r a_i z^{-1} + r^2 z^{-2}} \cdot y_k \quad (3)$$

Filtering of the remaining signal \tilde{y}_k^j with the last notch filter $H_j(z^{-1})$ will give us the prediction error for the estimation of the frequency component f^j :

$$\epsilon_k^j = H_j(z^{-1})\tilde{y}_k^j = \frac{1 + a_j z^{-1} + z^{-2}}{1 + r a_j z^{-1} + r^2 z^{-2}} \cdot \tilde{y}_k^j \quad (4)$$

Minimization of this prediction error ϵ_k^j will lead to estimate the error gradient:

$$\Psi_{k-1}^j = -\frac{d\epsilon_k^j}{da_j} = \frac{(1-r)(1-rz^{-2})}{(1+ra_jz^{-1}+r^2z^{-2})^2} \cdot \tilde{y}_{k-1}^j \quad (5)$$

Real time implementation of the frequency estimation leads to use the following Recursive Maximum Likelihood (RML) algorithm for an output Prediction Error Method (PEM):

$$\begin{aligned} & \text{for } j = 1, \dots, p \text{ do} \\ & 1) \text{ compute the prediction } \epsilon_k^j \\ & 2) \hat{a}_k^j = \hat{a}_{k-1}^j + F_{k-1}^j \Psi_{k-1}^j \epsilon_k^j \\ & 3) F_k^j = \frac{F_{k-1}^j}{(\lambda + \Psi_{k-1}^j F_{k-1}^j \Psi_{k-1}^j)} \end{aligned} \quad (6)$$

for each time instant k , where:

- $\hat{a}_k^j = -2\cos(2\pi\hat{f}_k^j T_s)$
- F_k^j is the adaptation gain
- $0 < \lambda < 1$ is the forgetting factor

Several second order notch filter cells are applied in a cascaded way to removed the frequency components successively from the prediction equation error. The implementation structure is shown on the figure 4. The cascaded cells are adapted in a recursive manner. In fact, the current cell input is the output prediction error of the previous ones.

3.3 Tracking Capabilities

The notch filter bandwidth parameter r_k is time varying: starting from a value r_0 to r_f according to the following expression:

$$r_k = r_d r_{k-1} + (1 - r_d) r_f \quad (7)$$

$0 < r_k < 1$ defines the position of the filter poles along frequency radials in the z plan. $r_k \approx 0$ means that poles are close to the origin whereas $r_k \approx 1$ means that poles are close to the unit circle (narrow bandwidth). r_d is the exponential coefficient of the filter bandwidth evolution, it is typically 0.99. The convergence and performance of frequency estimation using ANF are developed in (M'Sirdi and al., 2018) and (M'Sirdi et al., 1988).

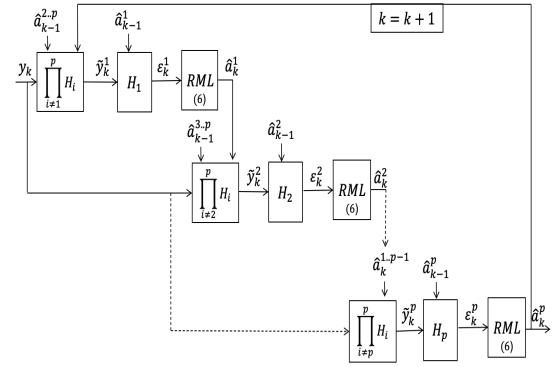

Figure 4: Frequencies estimation stage of ANF algorithm.

3.4 Amplitudes and Phases Estimation

Once the frequencies of the signal components f^i are known or estimated, we can use a Weighted Recursive Least Squares (WRLS) to estimate amplitude and phase of each component.

The signal defined in equation 1 can be decomposed in a Fourier basis as follows:

$$y_k = \sum_{i=1}^p [g_k^i \cos(2\pi f_k^i T_s k) + h_k^i \sin(2\pi f_k^i T_s k)] + v_k \quad (8)$$

where $C_k^i = \sqrt{g_k^i{}^2 + h_k^i{}^2}$ is the amplitude of the i th frequency component and β_k^i its phase, at time k ($\tan(\beta_k^i) = g_k^i/h_k^i$).

The parameter vector $\hat{\theta}_k$ and regression vector Φ_k are defined as follows:

$$\begin{aligned} \hat{\theta}_k &= [g_k^1 \ g_k^2 \ \dots \ g_k^p \ h_k^1 \ h_k^2 \ \dots \ h_k^p]^T \text{ and } \Phi_k = [C_k, S_k]^T \\ C_k &= [\cos(2\pi\hat{f}_k^1 T_s k) \ \dots \ \cos(2\pi\hat{f}_k^p T_s k)] \\ S_k &= [\sin(2\pi\hat{f}_k^1 T_s k) \ \dots \ \sin(2\pi\hat{f}_k^p T_s k)] \end{aligned} \quad (9)$$

The Fourier parameters g^i and h^i are estimated using the WRLS:

$$\begin{aligned} \epsilon_k^0 &= y_k - \hat{\theta}_{k-1}^T \Phi_k \\ G_k &= \frac{1}{\lambda_0} \left(G_{k-1} - \frac{G_{k-1} \Phi_k^T \Phi_k G_{k-1}}{\lambda_0 + \Phi_k^T \Phi_k} \right) \\ \hat{\theta}_k &= \hat{\theta}_{k-1} + G_k \Phi_k \epsilon_k^0 \end{aligned} \quad (10)$$

where ϵ_k^0 is the a priori prediction error, G_k the adaptation gain and λ_0 the exponential forgetting factor typically chosen between 0.98 and 0.995.

The exponential convergence of this algorithm has been proved, provided that the data are informative (persistent excitation condition). The proof uses the results in (Johnson and col., 1982) and (M'Sirdi and al., 2018). This means the existence narrow band components in the signal.

4 APPLICATION

In order to test the performance of the online spectral estimation algorithm, we apply the signals measured on board of a prototype helicopter during a flight test. The objective is to determine if the algorithm is able to detect the predominant frequency (6Hz) and its associated amplitude.

4.1 Helicopter Lateral Vibration Case

We focus here on the lateral acceleration signal measured by the accelerometer placed under the pilot's seat ($\Gamma_{Y_{pilot}}$). This location is one of the most sensitive to vibrations, it is far from the center of gravity of the helicopter and subjected to the lateral bending mode excitations. This mode of the fuselage includes left/right yawing motion of the main rotor mast and lateral motion of the forward cabin. The motions of the airframe are illustrated in figure 5, that shows an overlay of the fuselage at its minimum and maximum displacement for the first lateral bending mode. The forward part of the cabin (which includes the pilot seat and the attitude heading reference system) sees mainly 6 Hz right-left lateral motion.

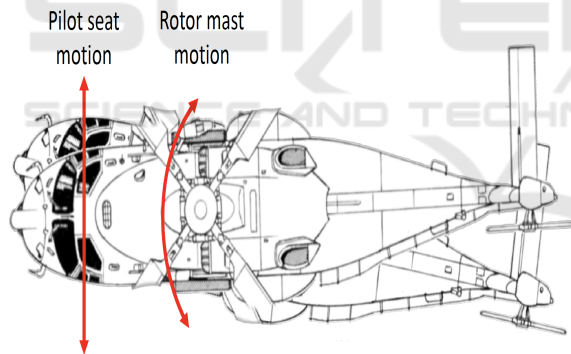

Figure 5: Helicopter first lateral bending mode (exaggerated for comprehension).

When looking at the evolution of the spectrum of lateral acceleration over time on figure 1, no significant vibration is present on the first seconds of the flight test record. From 6s, we observe a small oscillation varying around 8Hz. At 13s a 6Hz vibration is perceived and its amplitude increases strongly until reaching 0.5g at 16s. Then the vibration decreases because the test pilot changed the flight case to avoid damaging the structure of the helicopter.

It is certain that the pilot felt this vibration from the 13th second, given its amplitude and frequency. At this moment, the problem of the crew was no longer the detection of the anomaly but to leave the

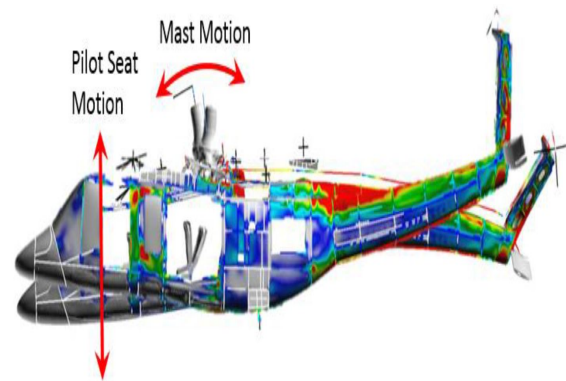

Figure 6: Helicopter first vertical bending mode (exaggerated for comprehension).

current flight case. Given the low amplitude of the vibrations (3mm of amplitude at 6Hz), the pilot was able to recover. But in some extreme case, the severity of vibrations prevents the pilot to act on the controls. Only automatic system could recover the helicopter to safe flight conditions.

Two automatic actions could be envisaged:

- Exit the flight case after the detection of severe vibrations (for example: automatic action on the controls to increase the rotational speed of the main rotor)
- Filter the AFCS output controls to eliminate the abnormal oscillations amplified by the feedback loops.

We present in the results the online spectral analysis of the lateral acceleration $\Gamma_{Y_{pilot}}$ performed with adaptive notch filters. Severe lateral vibrations can be detected when the amplitude of the $\Gamma_{Y_{pilot}}$ frequency components exceeds a given threshold. In parallel all controls sent to actuators can be analysed, in particular the yaw control δ_{ped} (tail rotor collective pitch control). If a strong vibration is detected on $\Gamma_{Y_{pilot}}$ and its frequency is present in the controls spectrum, it could be filtered using the associated notch filter.

The detection and tracking of significant oscillations and the estimation of their frequencies must be fast enough to be able to filter them efficiently. The adaptive notch filter method is particularly suited to the filtering of unexpected vibration since it directly gives the notch filter to be used and thus eliminate the propagation of corresponding oscillations in the control loop.

4.2 Methods Setting

ANF. The parameter estimates \hat{a}^j are set to zero initially. For the ANF bandwidths, r_0 is 0.5, and r_f is chosen such that the poles of H_i are as close as possi-

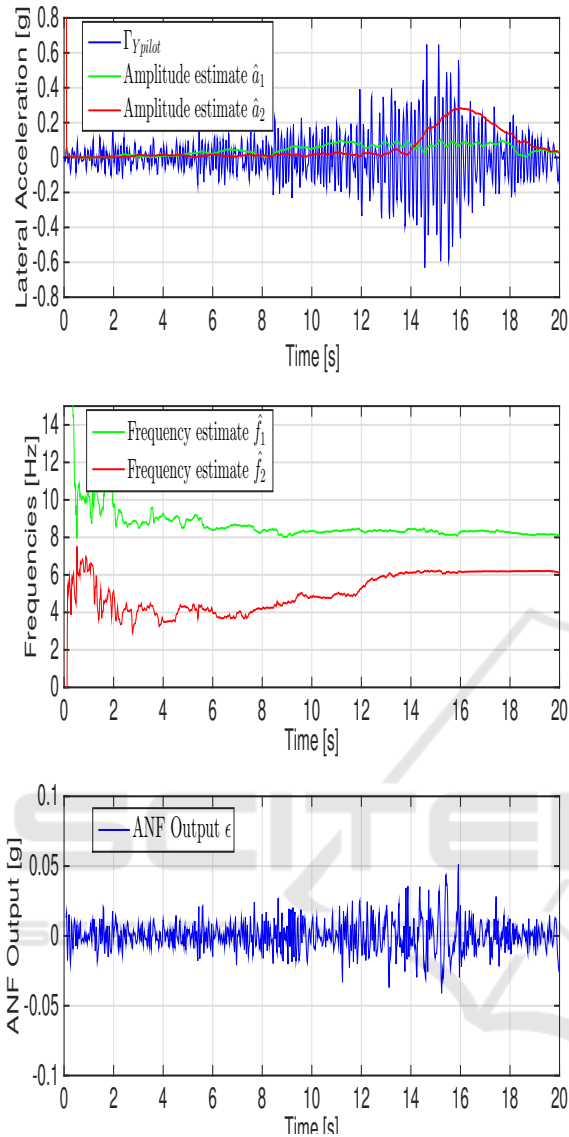

Figure 7: Online spectral estimation of helicopter lateral acceleration $\Gamma_{Y\ pilot}$.

ble to the unit circle. We use $r_f = 0.85$. We choose $p = 2$ to study the frequency content of $\Gamma_{Y\ pilot}$ and $p = 3$ for δ_{ped} .

WRLS. The initial value of the adaptation gain is set to a large value, typically $G_0 = 100$. The forgetting factor λ_0 is set to 0.99, and the parameters vector $\hat{\theta}(0)$ is initially set to 0.

4.3 Results

We present on figure 7 the online spectral analysis of the lateral acceleration signal $\Gamma_{Y\ pilot}$. The second curve of this figure depicts the frequencies estimate of the two main oscillations using ANF algorithm. We

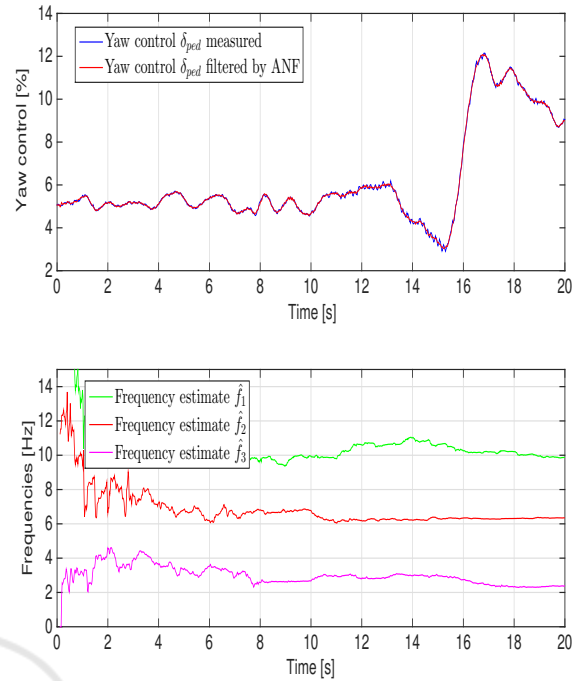

Figure 8: Online spectral estimation of helicopter yaw control δ_{ped} .

observe that the first frequency estimate \hat{f}_1 is varying until 6s where it converges to 8.2Hz. In parallel, the weighted recursive least squares algorithm estimates the amplitude of this first oscillation using the current frequency estimate. Amplitude estimate \hat{a}_1 is showed in green on the first curve, it never exceeds 0.1g. A second frequency band is tracked by \hat{f}_2 and converges to 6Hz from the 13th second. The amplitude estimate \hat{a}_2 of this frequency band shows a rapid increase from 14s to 16s when it reaches 0.28g. The third curve represents the output of the filter, we observe that it gradually increases from 11s to 16s, this is due to the presence of others frequency components than 8.2Hz and 6Hz. In fact when looking at the spectrum evolution, other frequency components appear from 11s at higher frequencies. This is due to main rotor modes that develops during this high dynamical phase. These frequencies are not estimated by the two notch filters, they appear as error. This spectral analysis can be used to detect exaggerate vibration and exit the current flight conditions. For example, at 15s, the information of exceedance of 0.2g at 6Hz can be send to the autopilot computer which would act on the actuators to change the main rotor states and therefore decrease the level of vibration.

We present on figure 8 the online spectral analysis of the yaw control signal δ_{ped} . The second graphic of this figure shows the 3 frequencies estimates of the signal. Note that the 6Hz oscillation (in red) is

present from 11s. The first graphic shows δ_{ped} measured (in blue) and its filtered counterpart (in red) using the notch filter centered on the second frequency estimate \hat{f}_2 . In practice, we could trigger the filtering of 6Hz at 15s after severe vibration detection on Γ_{Ypilot} .

5 CONCLUSION AND PERSPECTIVES

Online estimation of the spectral component of vibrations has been proposed based on use of Adaptive Notch Filters. Frequency tracking is done using a Recursive Maximum Likelihood (RML) algorithm and Amplitudes and Phases Estimation (APE) adapted by a Weighed Recursive Least Square (WRLS) algorithm. This method allows on estimation and tracking of the narrow band frequencies and their amplitudes and phases.

The main interest of the ANF is the fast tracking of time-varying frequencies and allows to get directly accurate prediction of the vibration components to be compensated. Moreover, this algorithm, being very fast and with reduced complexity can be easily implemented on computing resources of an aircraft thanks to its low number of coefficients to estimate (one coefficient for each frequency component). The proposed approach has been applied to the case of an helicopter flying in flight test conditions and having a severe vibration.

The application results validate the good performance and efficiency of the proposed algorithms to characterize and track oscillations. Moreover, a strategy based on detection and filtering has been suggested to prevent propagation of abnormal oscillations in the flight control loop. The proposed APE allows predictions of the vibrations in case where large prediction horizon can be needed.

The experimental validations on helicopters and the integration with active vibration control systems is in progress. Extensions of this work will be done in case of longer prediction horizon is needed (e.g. for integration of the compensation in the control loop) and for model prediction control of the helicopter.

The main concern of the future work will be integration of the ANF in the helicopter autonomous flight robust control, to enhance the robustness versus perturbations.

REFERENCES

- Al-Badour, F., Sunar, M., and Cheded, L. (2011). Vibration analysis of rotating machinery using time frequency analysis and wavelet techniques. In *Mechanical Systems and Signal Processing*, volume 25, pages 2083–2101.
- Betta, G., Liguori, C., and al. (2002). A dsp-based fft-analyzer for the fault diagnosis of rotating machine based on vibration analysis. In *IEEE Transactions on Instrumentation and Measurement*, volume 51, pages 1316–1322.
- Johnson, R. M. and col. (1982). Exponential convergence of rls with exponential forgetting factor. *System and control letters*.
- Krysinski, T. and Malburet, F. (2007). *Mechanical Vibrations: Active and Passive Control*. ISTE.
- M'Sirdi, N. and al. (2018). Adaptative notch filters for prediction of narrow band signals. In *7th International Conference on Systems and Control*, Valencia, Spain.
- M'Sirdi, N. and Landau, I. (1987). Adaptive evolutionary spectrum analysis for narrow band signals. In *ICASSP, IEEE International Conference on Acoustics, Speech and Signal Processing*.
- M'Sirdi, N. K., Tjokronegoro, H. R., and Landau, I. D. (1988). An rml algorithm for retrieval of sinusoids with cascaded notch filters. In *ICASSP-88, International Conference on Acoustics, Speech, and Signal Processing*, volume 4, pages 2484–2487.
- Nehorai, A. (1985). A minimal parameter adaptive notch filter with constrained poles and zeros. In *Proceedings of ICASSP 85, IEEE International Conference on Acoustics, Speech, and Signal Processing*, volume 10, pages 1185–1188.
- NTSB (2018). Bell 525 crash report dca16fa199. Technical report, The National Transportation Safety Board (NTSB), Washington, USA.
- Qin, Z., Chen, L., and Bao, X. (2011). Continuous wavelet transform for non-stationary vibration detection with phase-otdr. In *Optics express*, volume 20, pages 20459–20465.
- Wang, W. and Wong, A. (1986). Autoregressive model-based gear fault diagnosis. *Journal of Vibration and Acoustics*, 1274:172–179.