



HAL
open science

Static and RF electric field measurement based on Lyman-alpha emission from a hydrogen probe beam

Laurence Chérigier-Kovacic

► **To cite this version:**

Laurence Chérigier-Kovacic. Static and RF electric field measurement based on Lyman-alpha emission from a hydrogen probe beam. XXXIV International congress on Phenomena in Ionized Gases, Jul 2019, Sapporo, Japan. hal-03390445

HAL Id: hal-03390445

<https://amu.hal.science/hal-03390445>

Submitted on 21 Oct 2021

HAL is a multi-disciplinary open access archive for the deposit and dissemination of scientific research documents, whether they are published or not. The documents may come from teaching and research institutions in France or abroad, or from public or private research centers.

L'archive ouverte pluridisciplinaire **HAL**, est destinée au dépôt et à la diffusion de documents scientifiques de niveau recherche, publiés ou non, émanant des établissements d'enseignement et de recherche français ou étrangers, des laboratoires publics ou privés.



***Static and RF electric field
measurement based on Lyman-alpha
emission from a hydrogen probe beam***

Laurence Chérigier-Kovacic

XXXIV ICPIG, July 2019, Sapporo, Japan

1. Introduction

Diagnostic to measure electric field amplitude

Quenching of metastable atoms by an electric field :
Electric Field Induced Lyman- α Emission (EFIELD)

Test in vacuum, in a plasma with an externally
controlled electric field

outline

1. Introduction
2. Principle of the experiment
3. Test measurements of a static electric field
 - in vacuum
 - in a plasma : sheath
4. Test measurements of a radiofrequency electric field
 - in vacuum
 - in a plasma
5. Project : Measurement of a radial electric field in a magnetized plasma column
6. Conclusion

2. Principle of the experiment

Quenching of metastable atoms by an electric field

quenching of metastable atoms by the electric field

Lamb & Retherford, PRL 79,4 (1950)

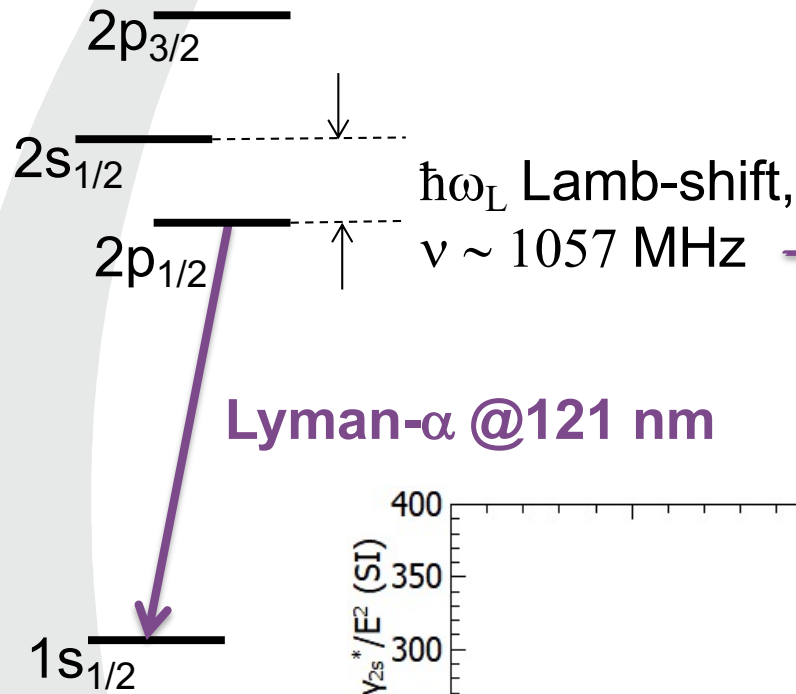

Electric field (E, ω)

→ Stark-mixing $2s_{1/2}, 2p_{1/2}$

→ $2s_{1/2}$ lifetime reduced

→ emission of Lyman- α @121 nm

Lyman- α @121 nm

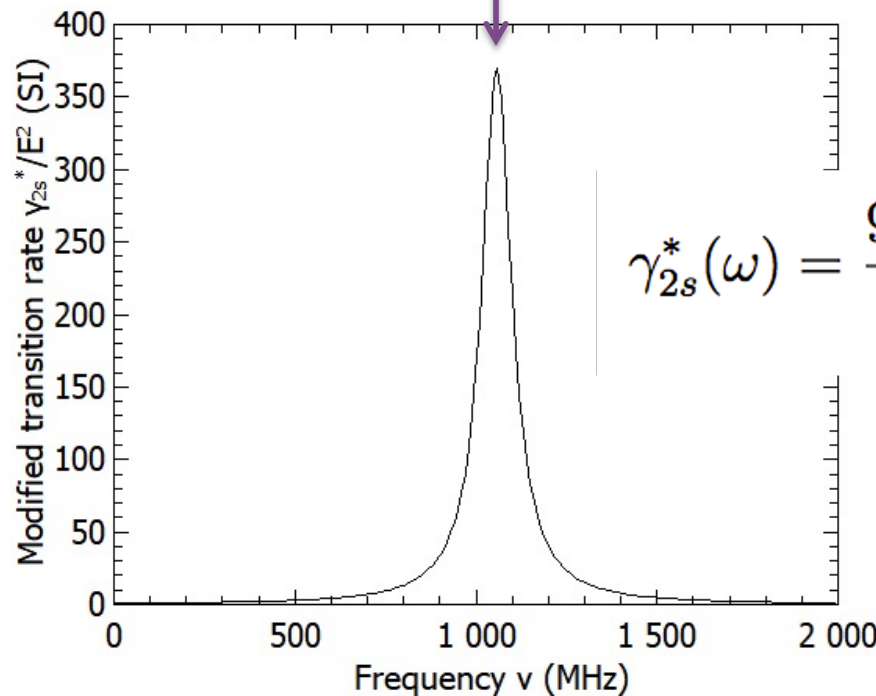

for $E_{\text{stat}} < 300$ V/cm

and $E_{\omega} < 20$ V/cm

$$\gamma_{2s}^*(\omega) = \frac{9e^2 a_0^2 E^2}{h^2} \underbrace{\frac{\gamma_{2p}}{(\omega - \omega_L)^2 + \gamma_{2p}^2/4}}_{L(\omega)}$$

experimental device

Detection of Lyman α
emission : VUV PM

Plasma source : 500 V polarization
+ Einzel lenses (extraction)

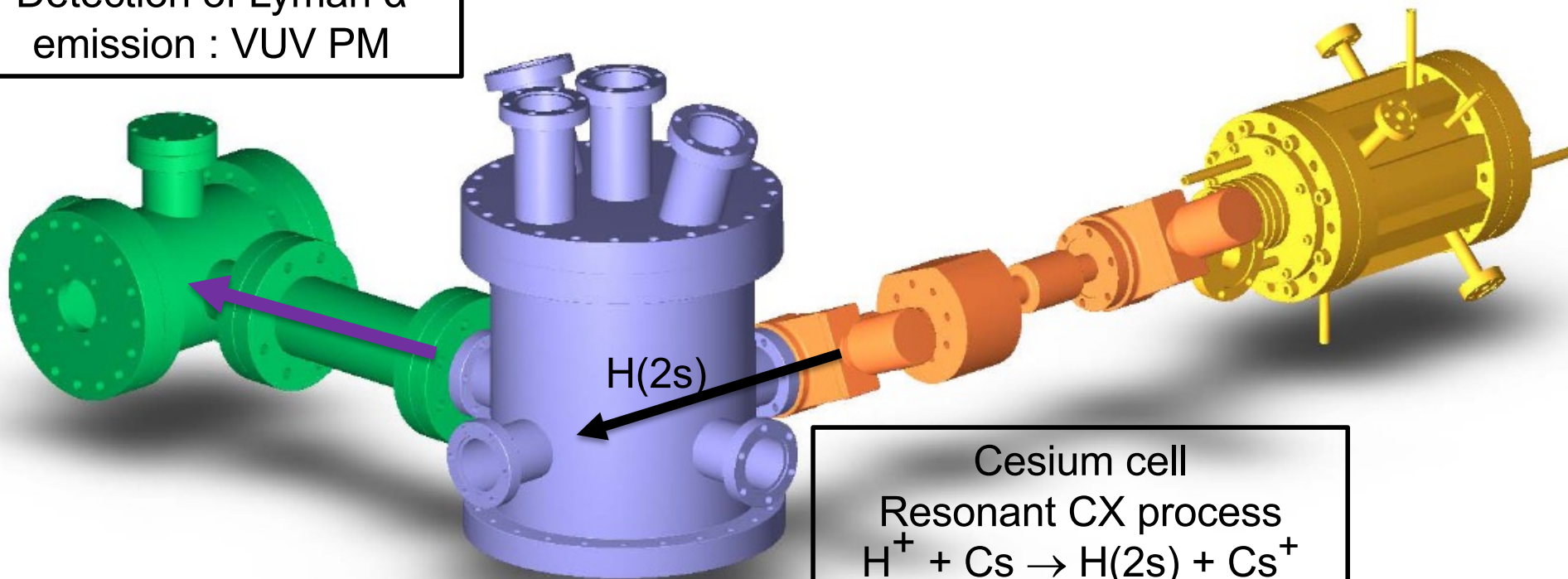

H(2s)

Cesium cell
Resonant CX process
 $H^+ + Cs \rightarrow H(2s) + Cs^+$

Measurement chamber :
interaction between probe beam and electric field
beam / plasma diagnostics

experimental device : external E field generation

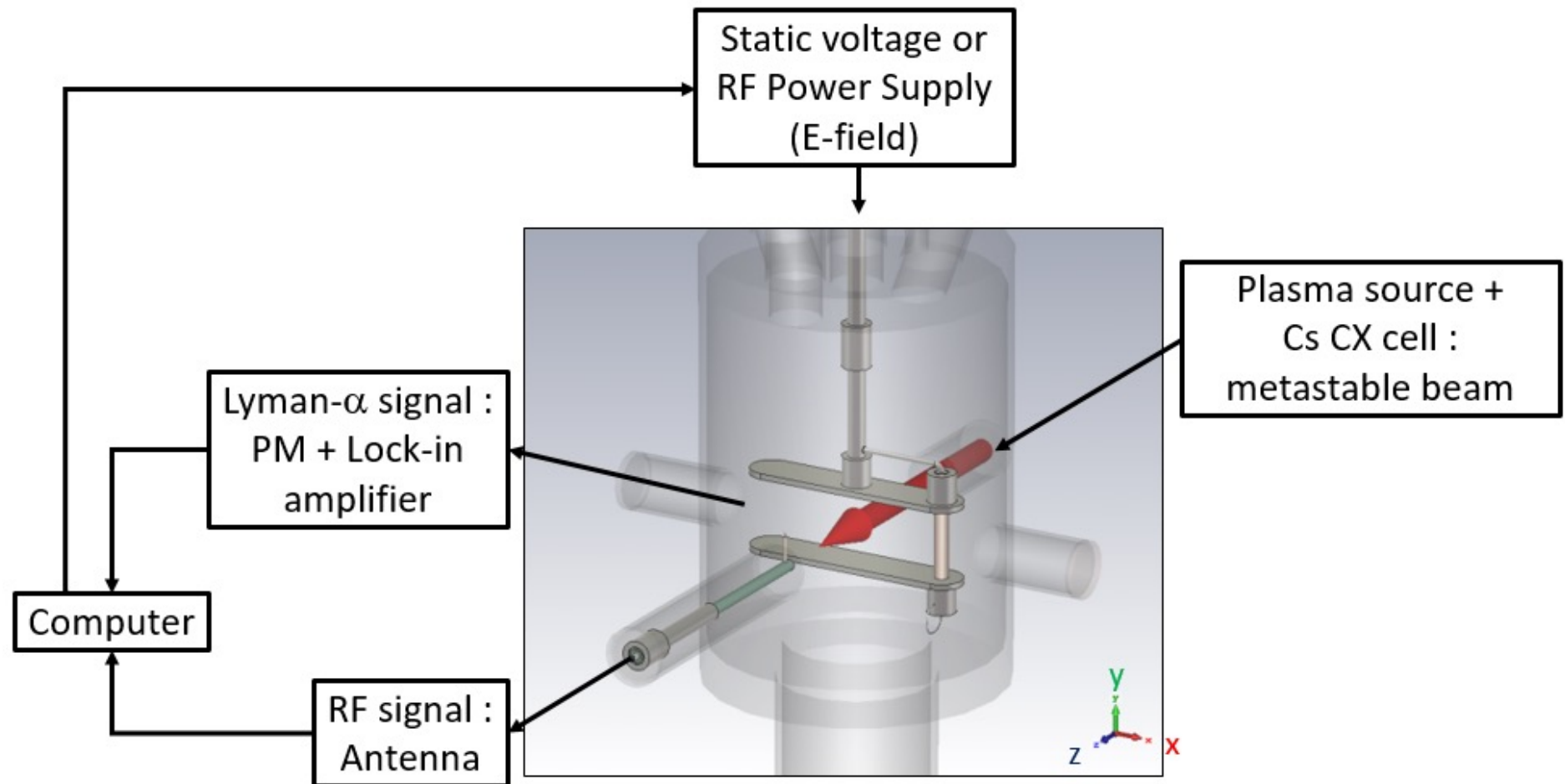

limits

- $S \propto E^2$
- Electric field 0.1 V/cm \rightarrow 500 V/cm
- Time resolution :
 - 1 s if pulsed beam,
 - period of oscillations of periodic phenomenon
- Spatial resolution : now, 1 cm

3. Measurement of a static electric field

Measurements in vacuum and in a plasma sheath

signal in vacuum for a static voltage

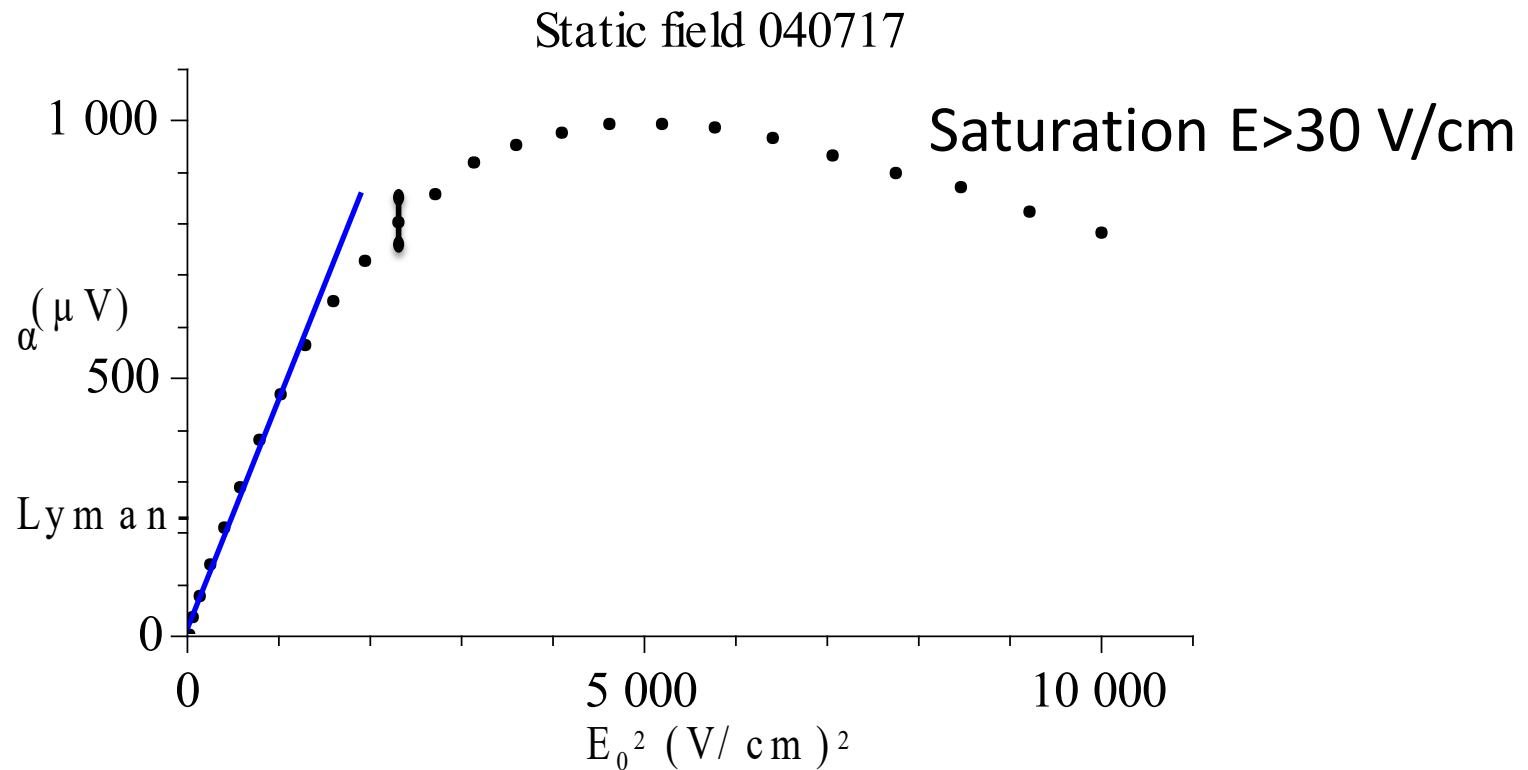

Saturation : loss of metastable due to the electric field before the diagnosed volume

signal in vacuum for a static voltage

Electric field profile between the plates :
Measurements + FEM simulation

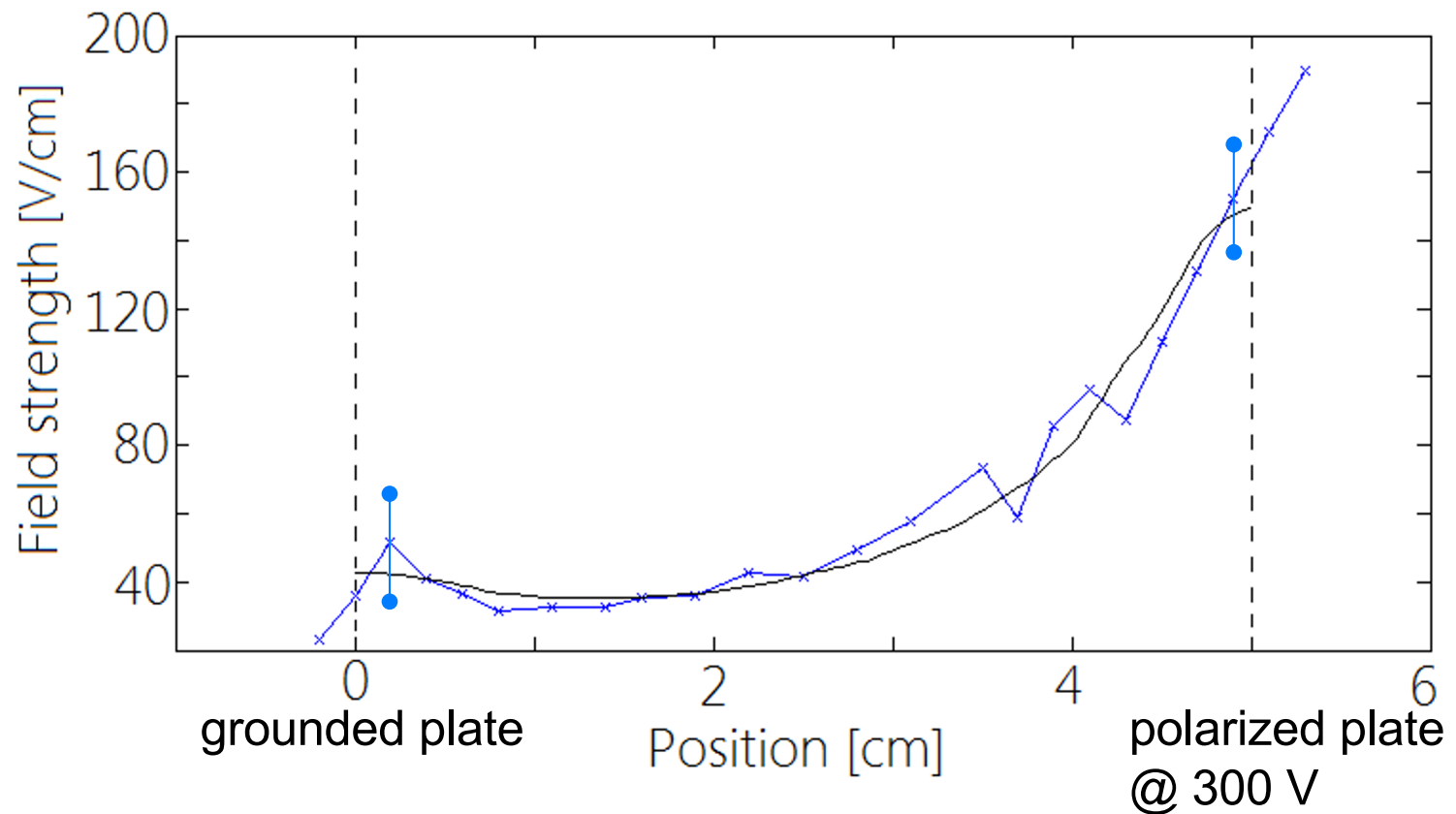

signal in an Ar plasma for a static voltage

Electric field profile between the plates : sheath

Field strength [Arbitrary unit]

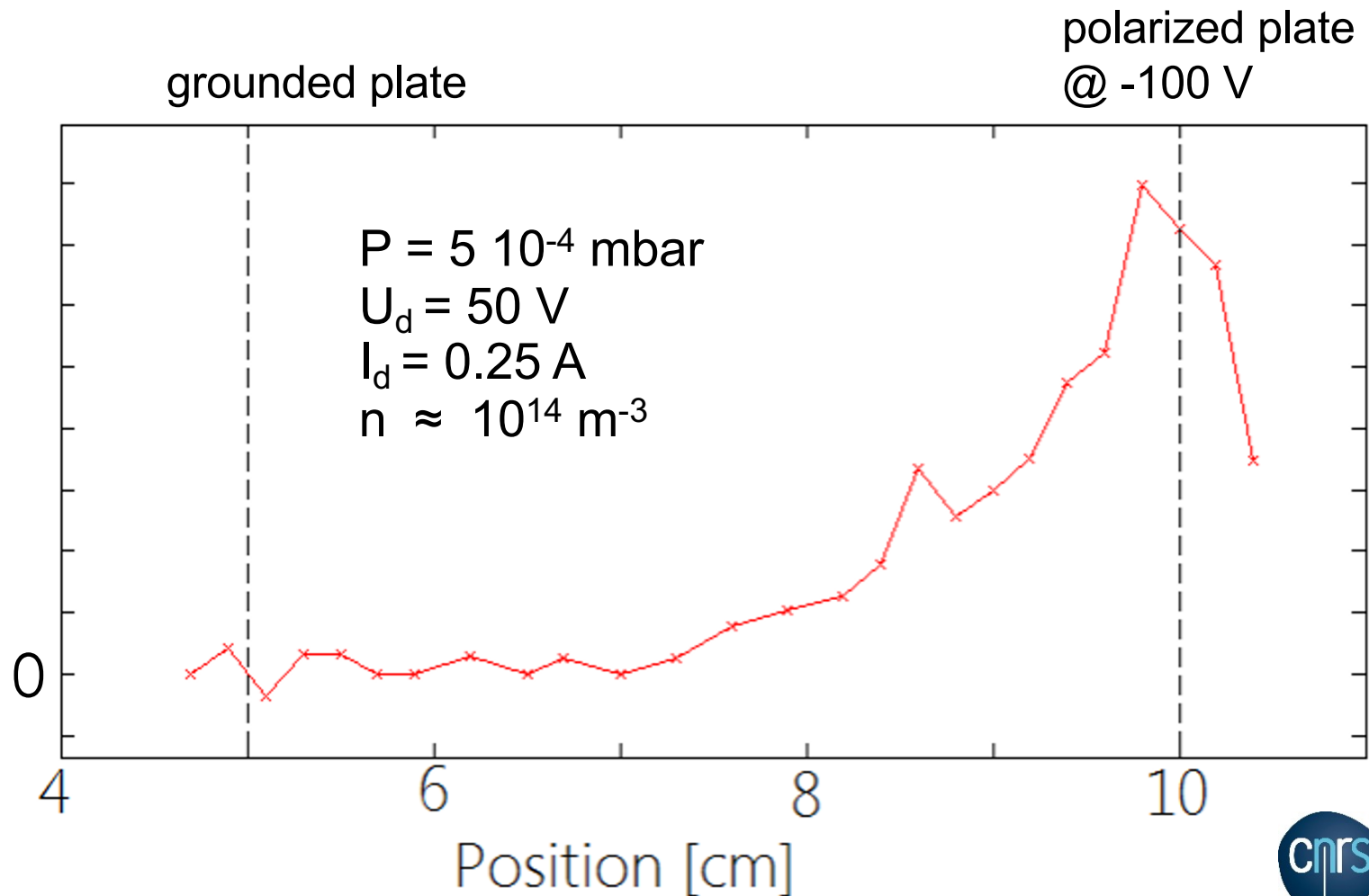

signal in an Ar plasma for a static voltage

Electric field profile between the plates : sheath

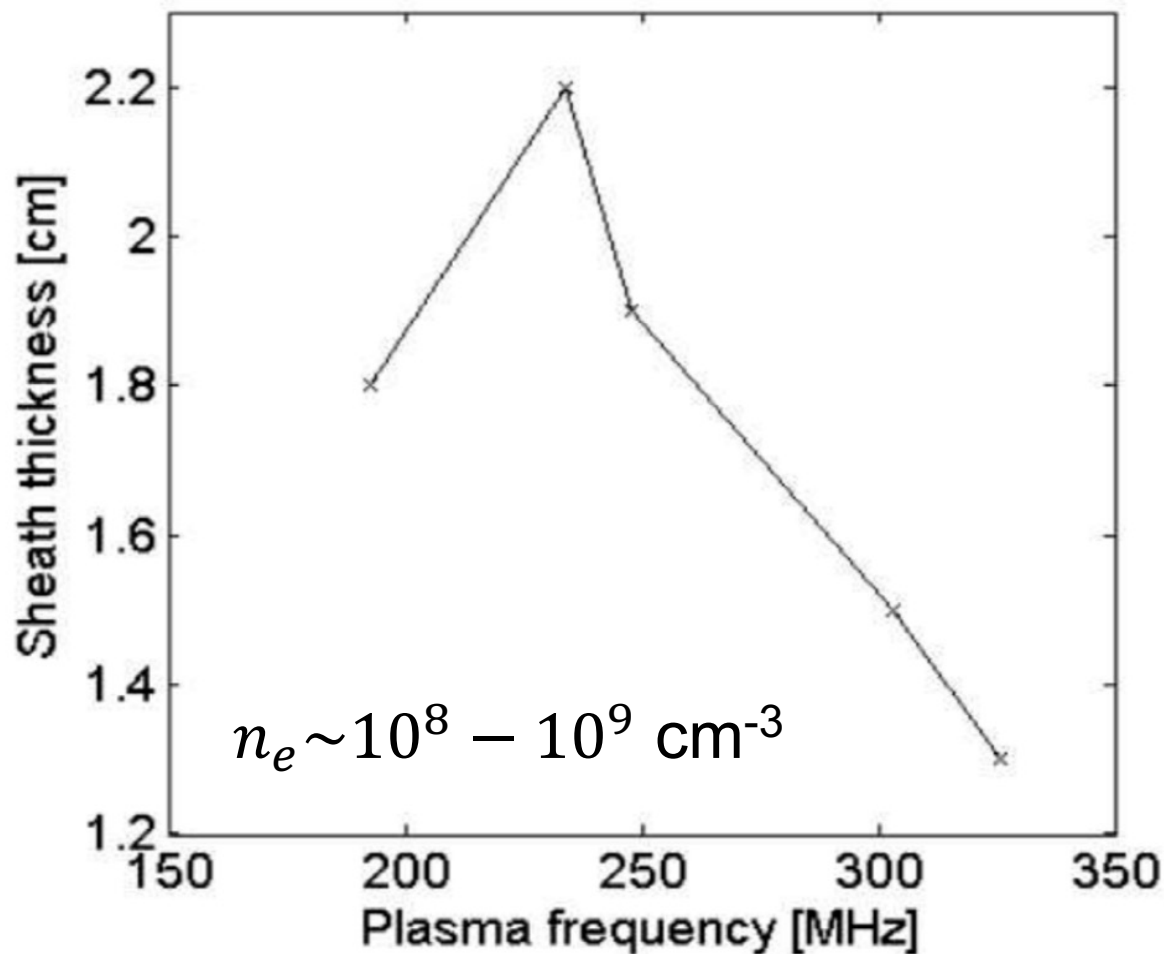

$$\omega_p = \sqrt{\frac{n_e e^2}{m_e \epsilon_0}} \text{ and } n_e \propto I_d$$

4. Measurement of a RF electric field

Measurements in vacuum and in a plasma

signal in vacuum for a RF voltage

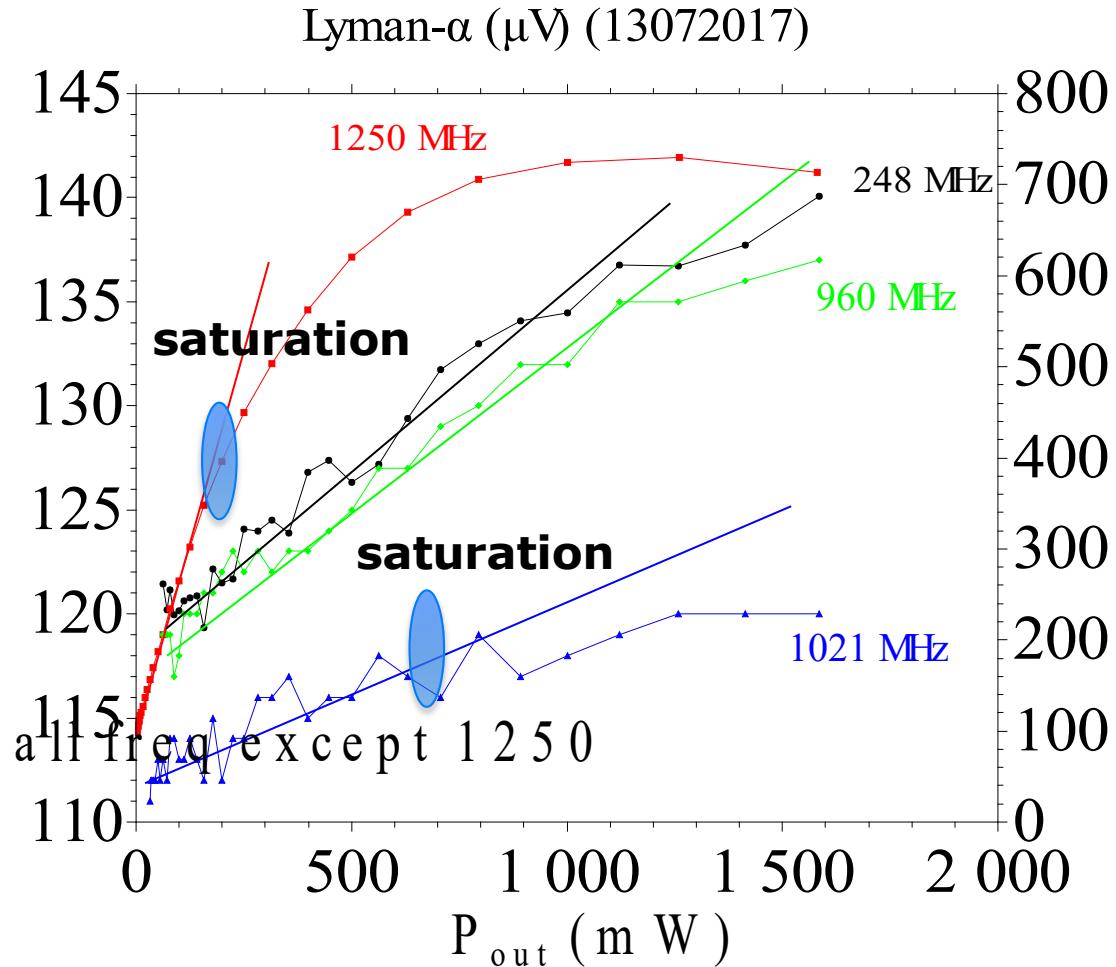

@

geometrical saturation depending on the electric field along the beam path

signal in vacuum for a RF voltage @1500 mW

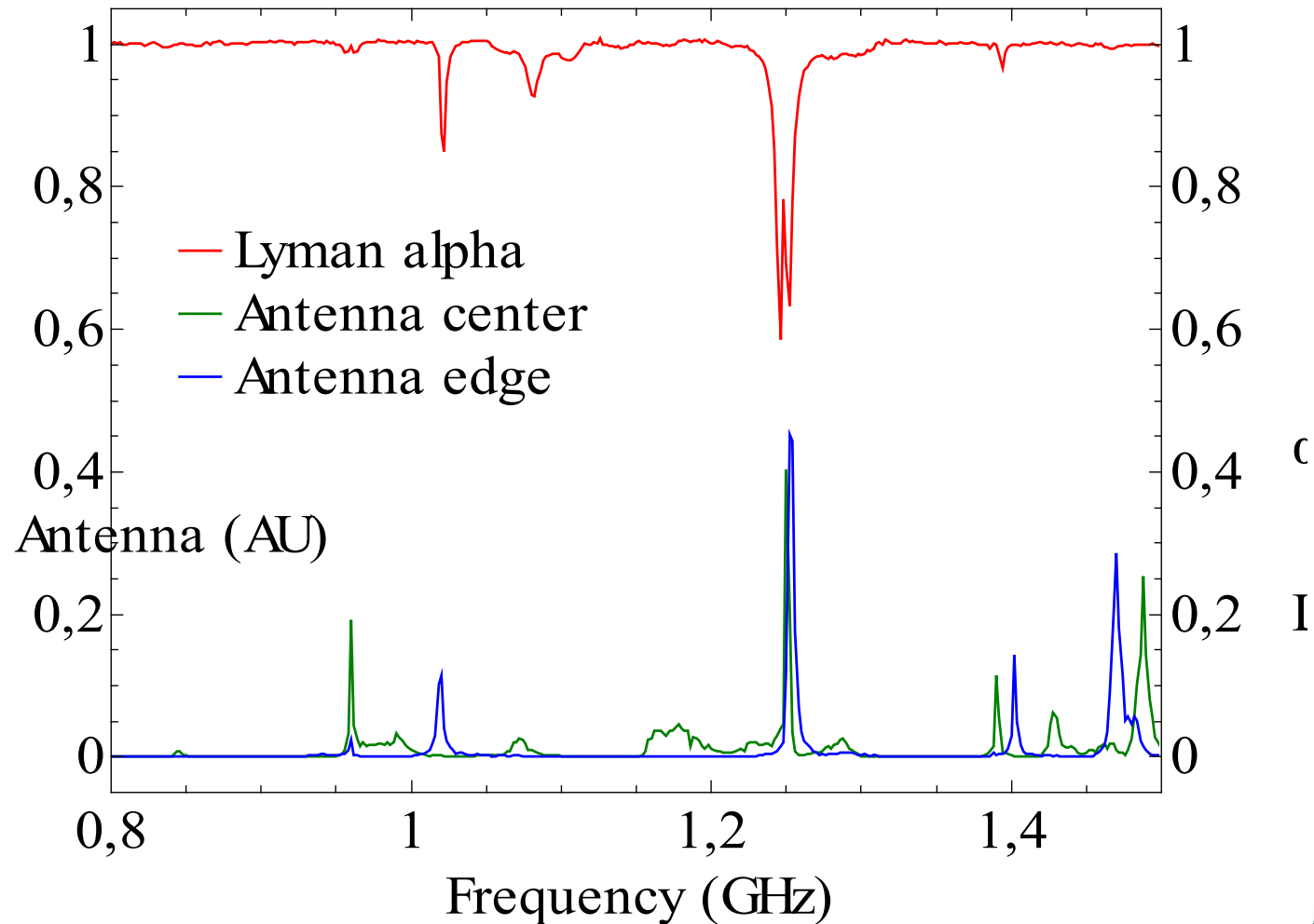

numerical calculation of the electric field in the vessel

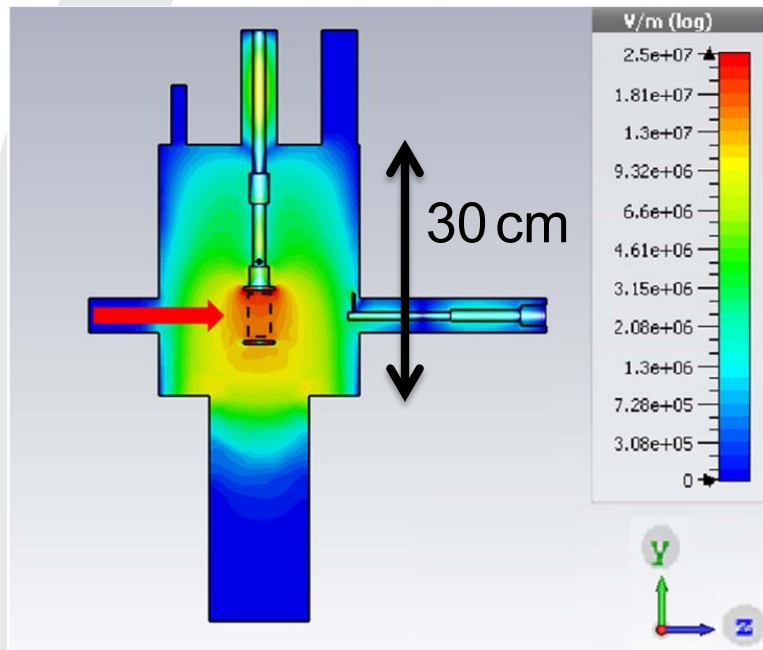

Field map

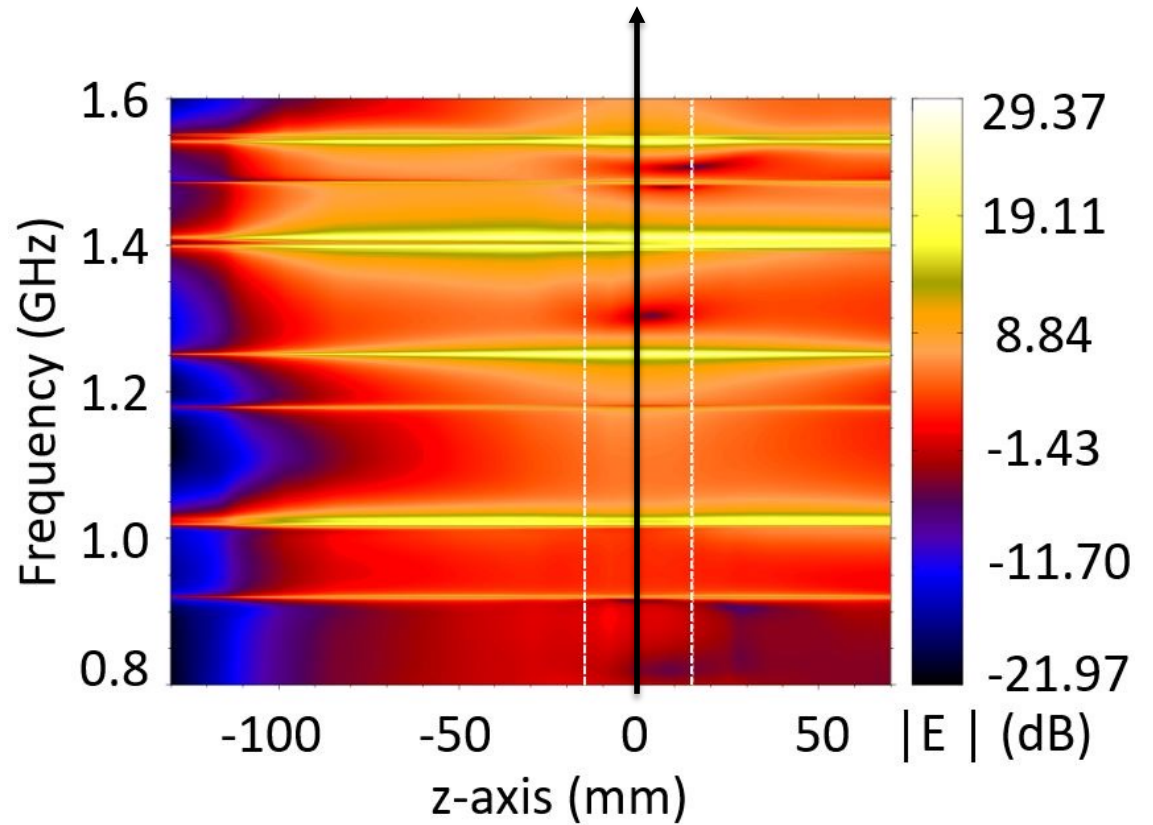

Calculated E field amplitude along the beam path for $P_{out} = xx$?

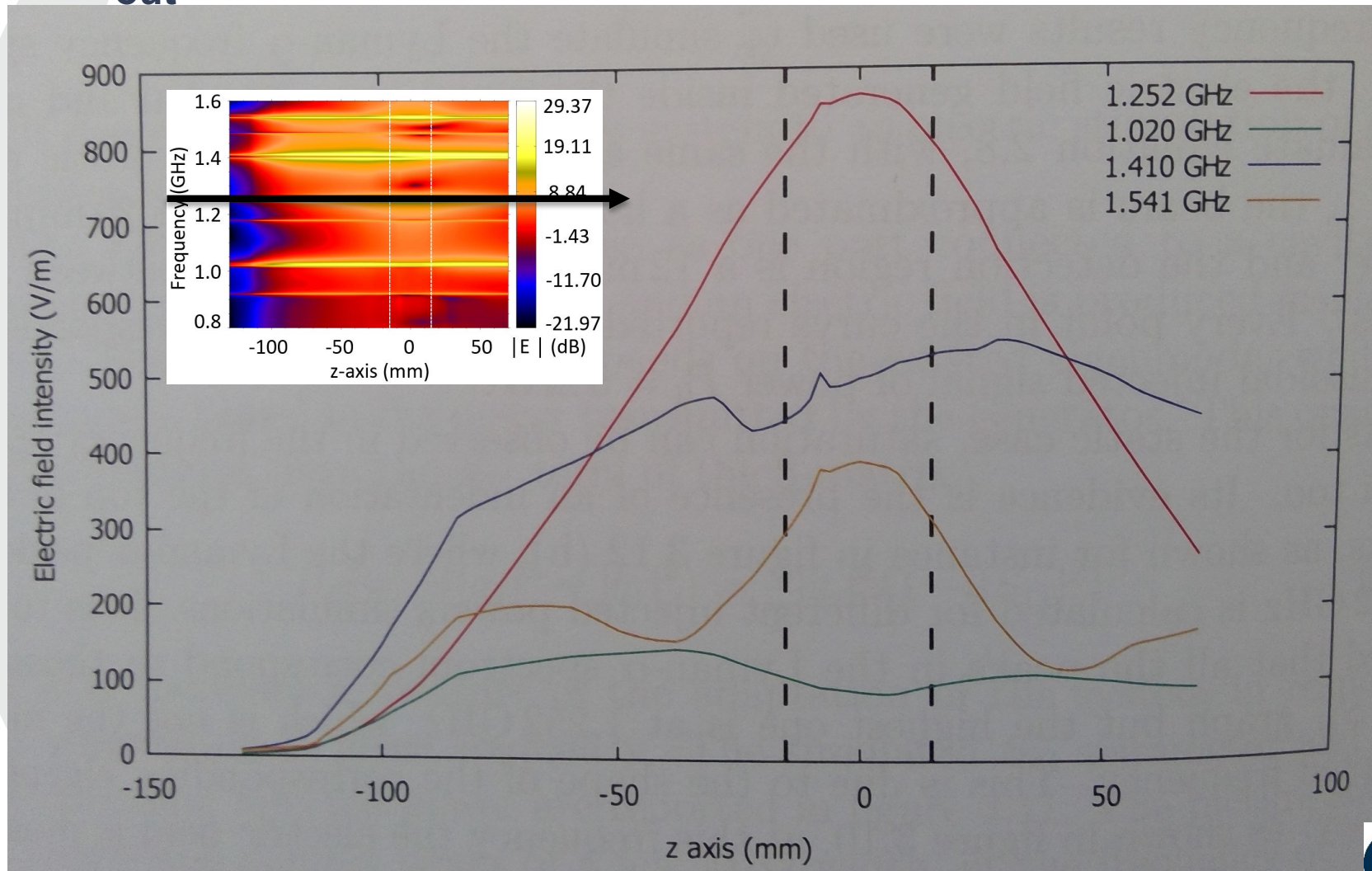

simulation / experiment comparison

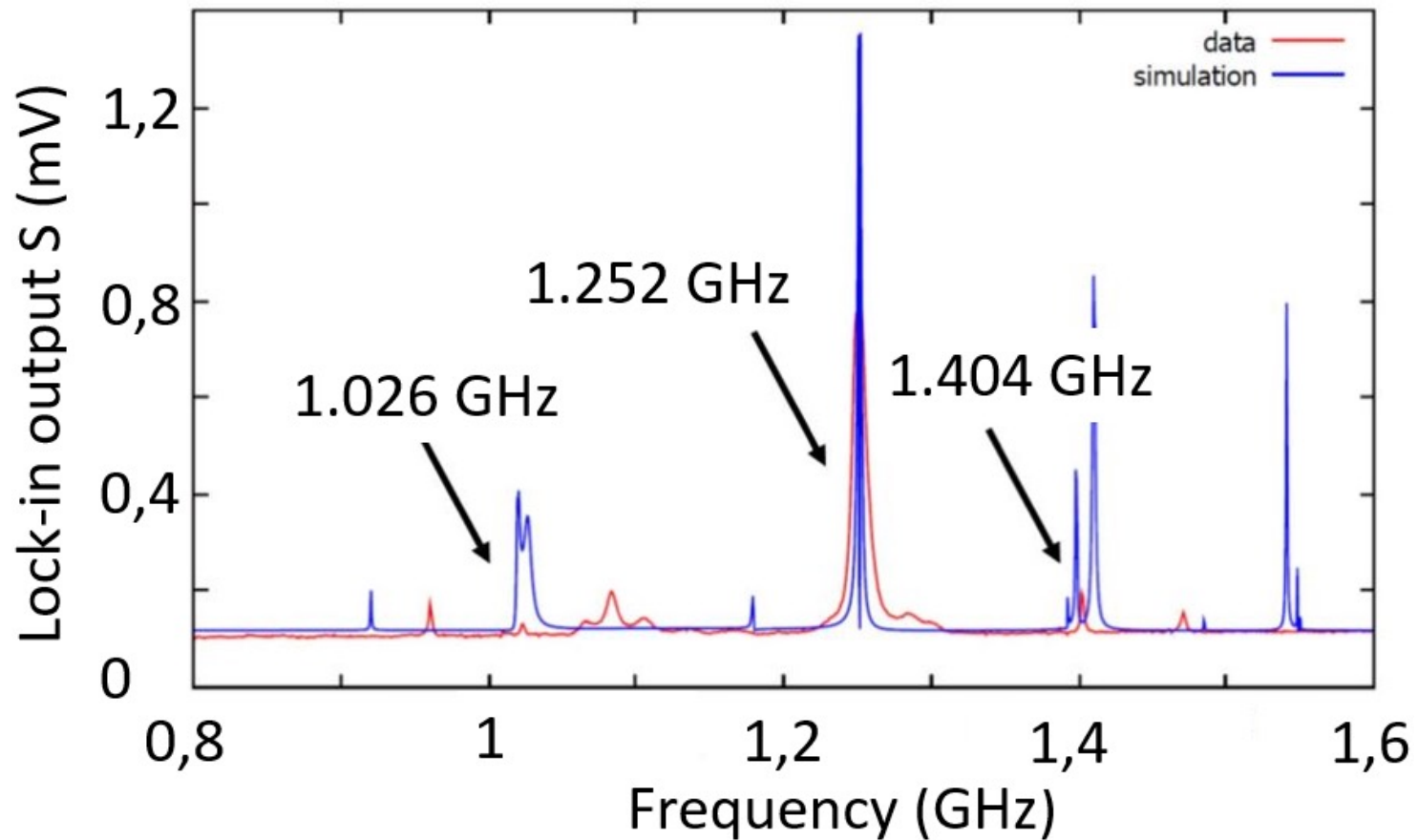

Lyman- α signal in presence of 1 GHz voltageage between the plates

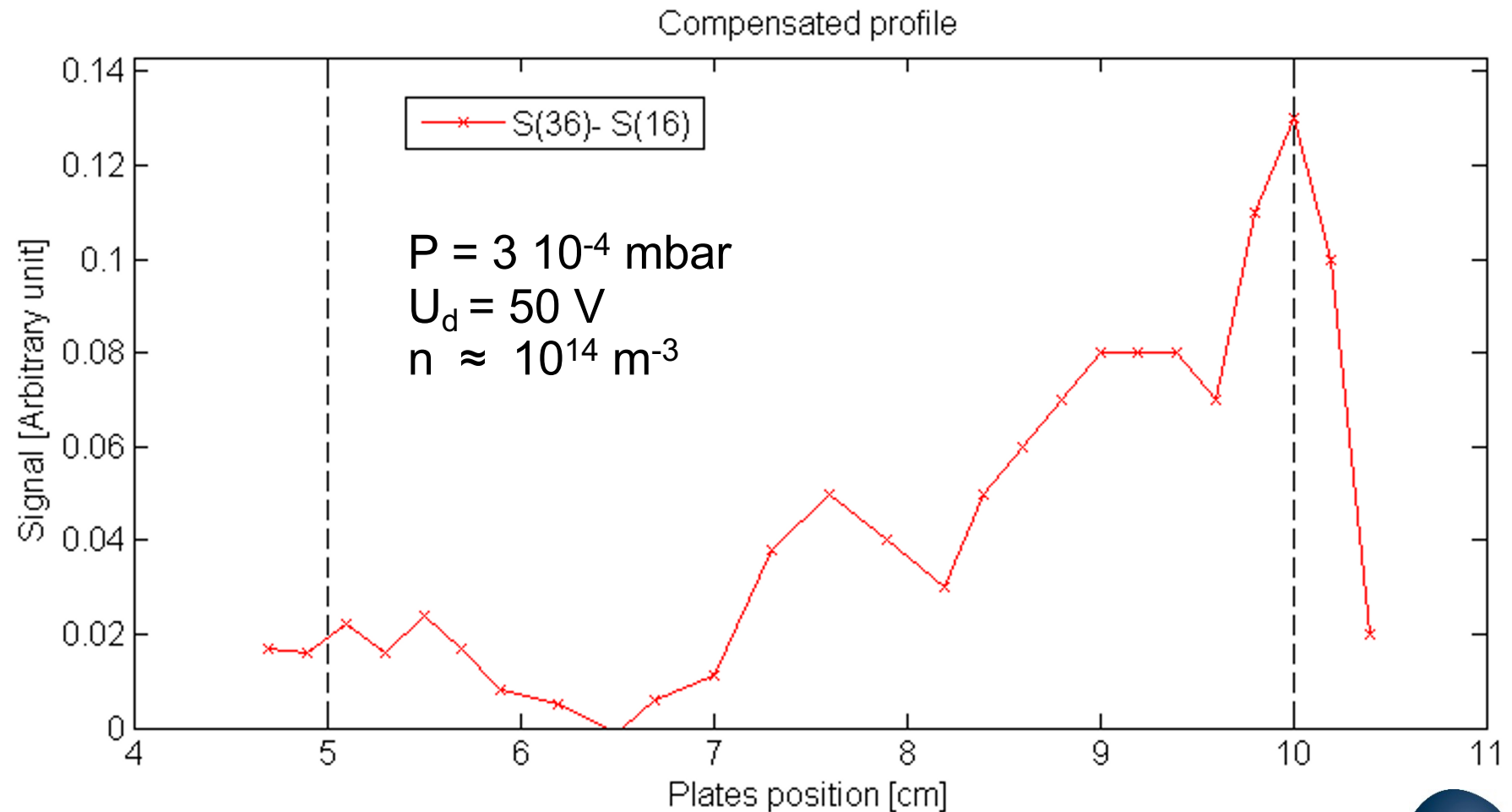

observation of resonance mode shift

Shift of 1252 MHz-mode

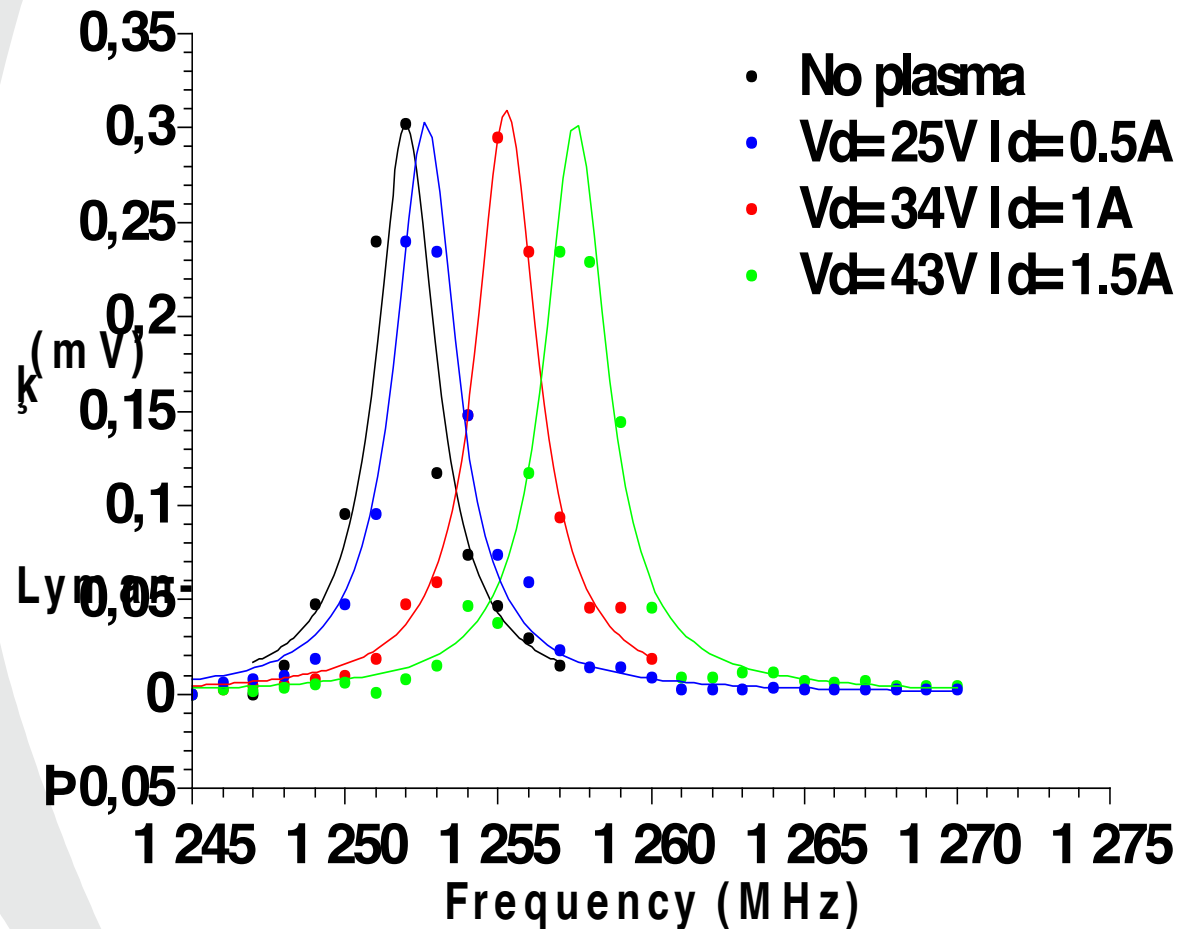

F (MHz)	n_e (cm ⁻³)
1252	0
1252,6	$1,8 \cdot 10^7$
1255,3	$1,0 \cdot 10^8$
1257,5	$1,7 \cdot 10^8$

$$n_e = \frac{2m_e \epsilon_0 \omega^2 \Delta\omega}{e^2 \omega_0}$$

5. Project : measurement of the radial electric field in a magnetized plasma column (MISTRAL)

- $L = 1.2 \text{ m}$, $r_{\text{inner cylinder}} = r_{\text{plasma}} = 36 \text{ mm}$
- $5 \cdot 10^{-5} \text{ mbar} < P < 10^{-3} \text{ mbar}$
- $B_{\text{solenoid}} < 25 \text{ mT}$

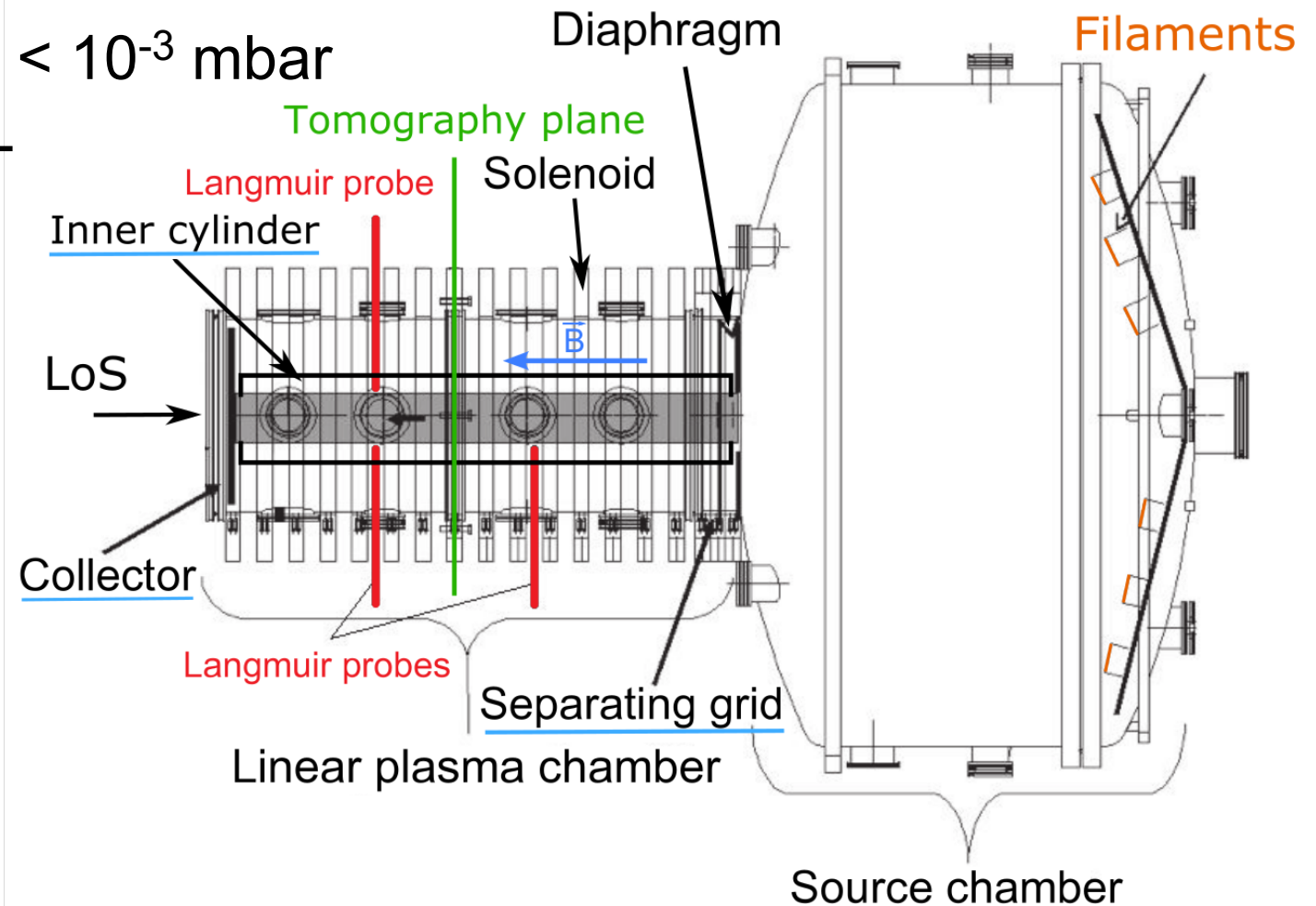

fast camera results (end view of the plasma) : rotating arm of plasma ejected from core

A. Escarguel, ExB workshop, Princeton Plasma Physic Lab, nov 2018.

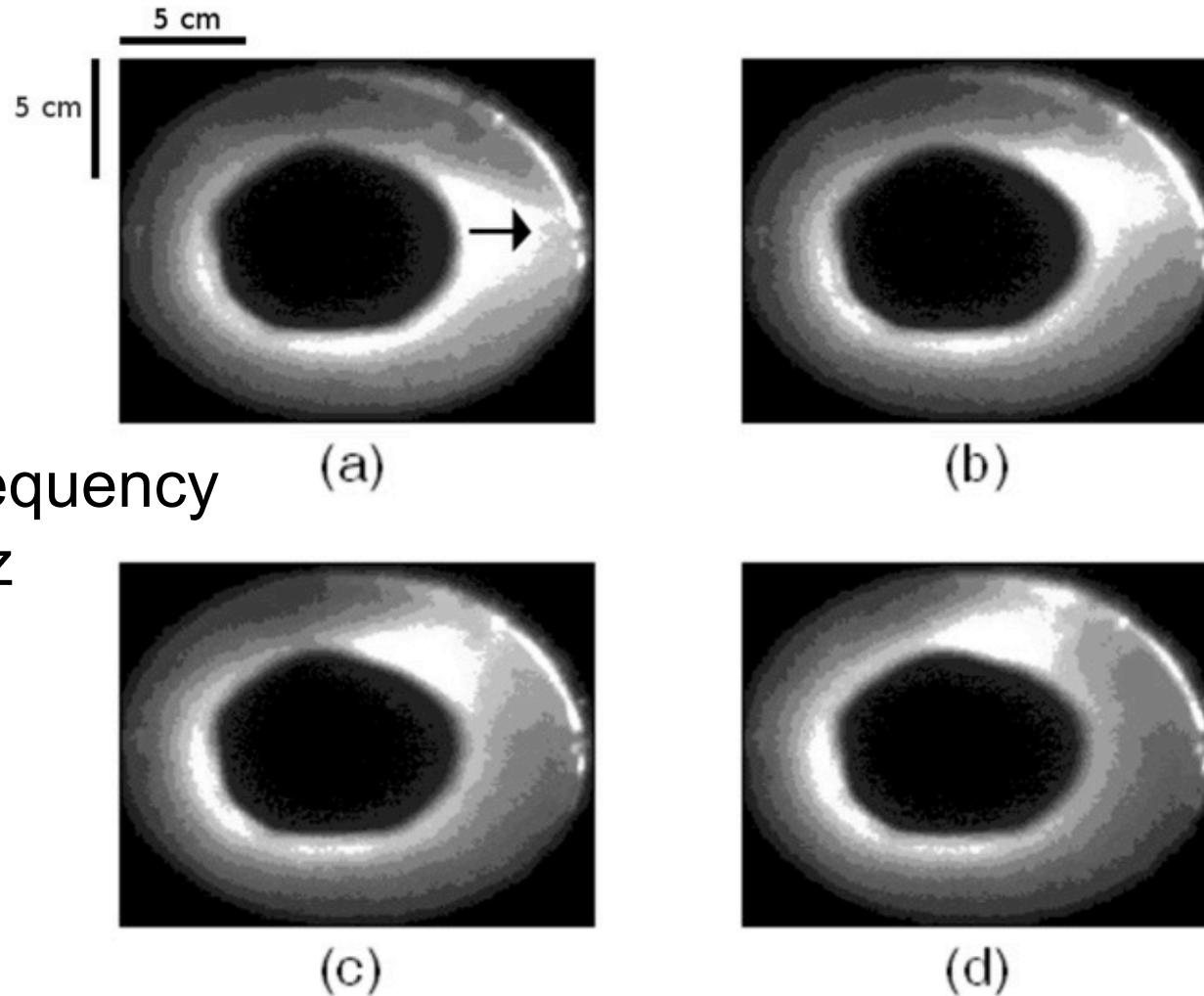

→ Rotation frequency
= a few kHz

measurement of the radial electric field in MISTRAL : Langmuir probe, synchronized with the rotating arm

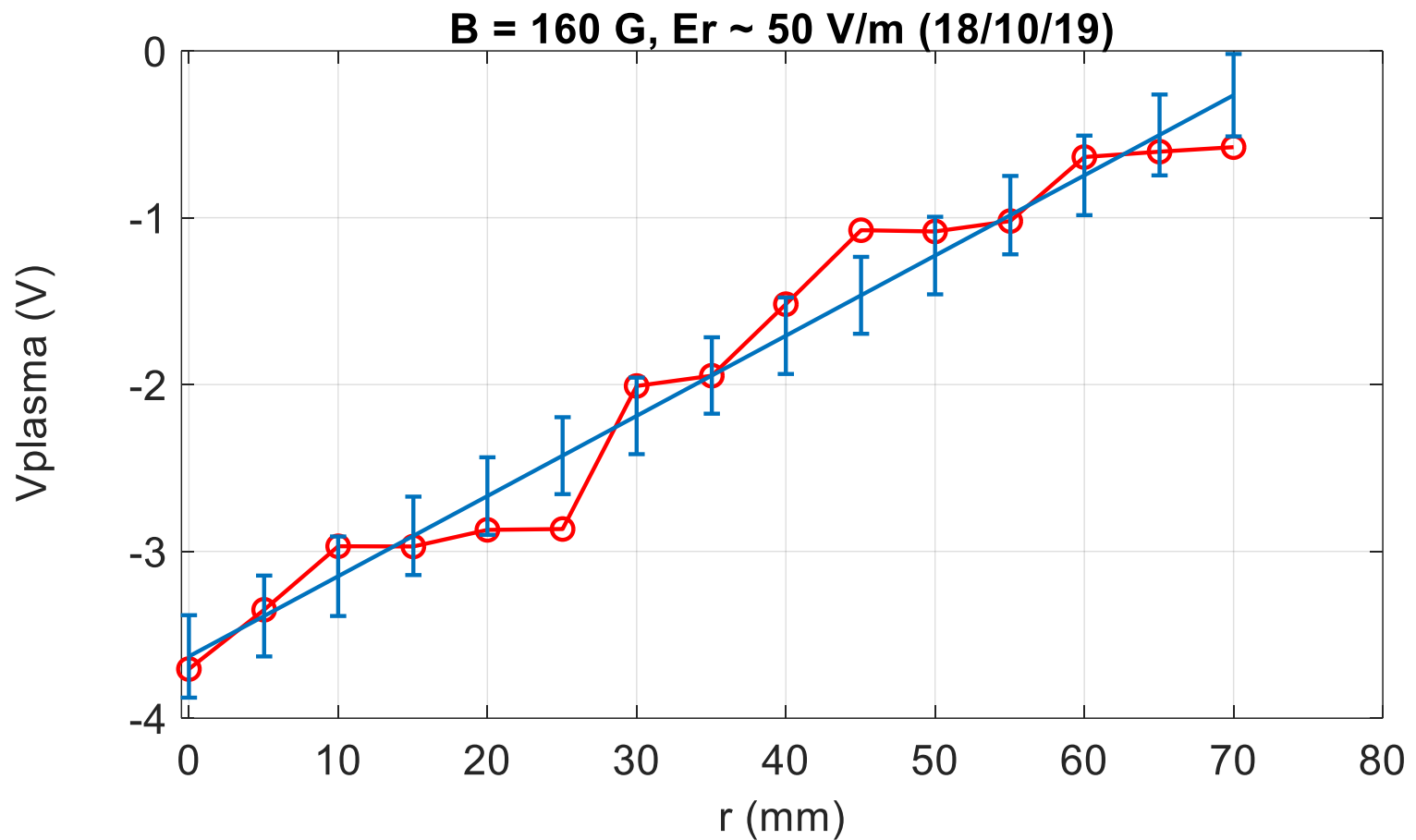

principle of the experiment

VUV detection $\rightarrow I(z)$

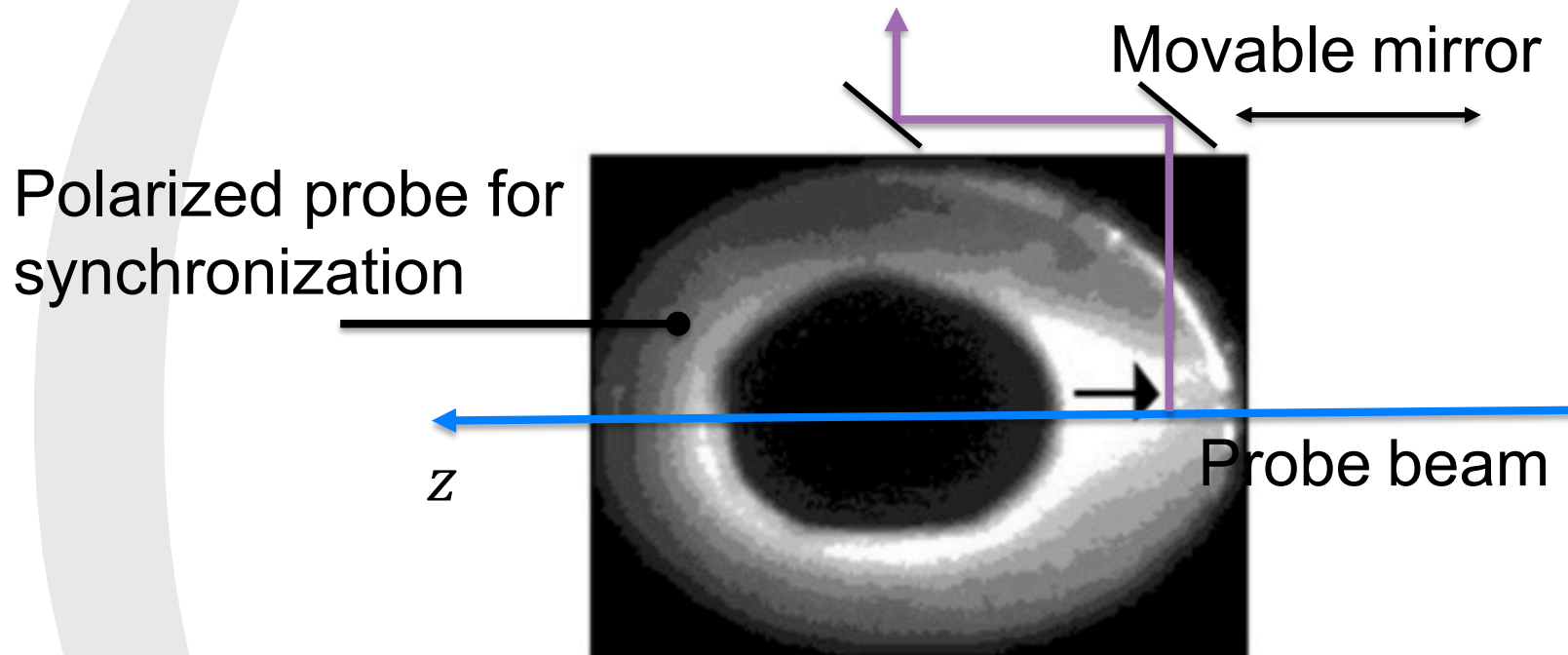

$$\frac{dN}{dz} = \frac{N(z)}{\tau_{2s}^*(E)v}$$

$$N(z) = \beta \int_z^{\infty} I(z') dz'$$

conclusion :

- Measurement of the electric field in vacuum and in a plasma 10^8 cm^{-3} by EFILE
- Static or radiofrequency, up to 1.4 GHz
- Signal at resonant frequencies of our vessel
 - good correlation with simulations in vacuum
 - RF signal in a plasma OK
- Next issue : calibration, superposition of static and RF voltages
- 2019 ongoing work – installation on a magnetized plasma column (MISTRAL) : test of EFILE against other method

collaborators :

- Fabrice Doveil (PIIM, CNRS)
- Carlo Poggi (M2 – Erasmus Université de Padoue/AMU)
- Théo Guillaume (M2 – AMU)
- Veronica Gonzalez (post-doc, PIIM, Eurofusion)
- Alexandre Escarguel (PIIM, AMU)
- Institut Fresnel, AMU : G. Demesy, P. Sabouroux, M. Dubois

thank you for your attention

acknowledgements :



[Hoh; Simon Phys. Fluids 1963 ; Jaeger PhD 2009]

Simon-Hoh instability **CSHI** (Phys. Fluids 1963)

ExB drift:

- Electrons : $v_{e\theta}$
- Friction forces (e-neutrals)

→ Ions slowed down:

$$v_{i\theta} < v_{e\theta}$$

→ Charge separation: E_1

→ Rotation frequency instability:

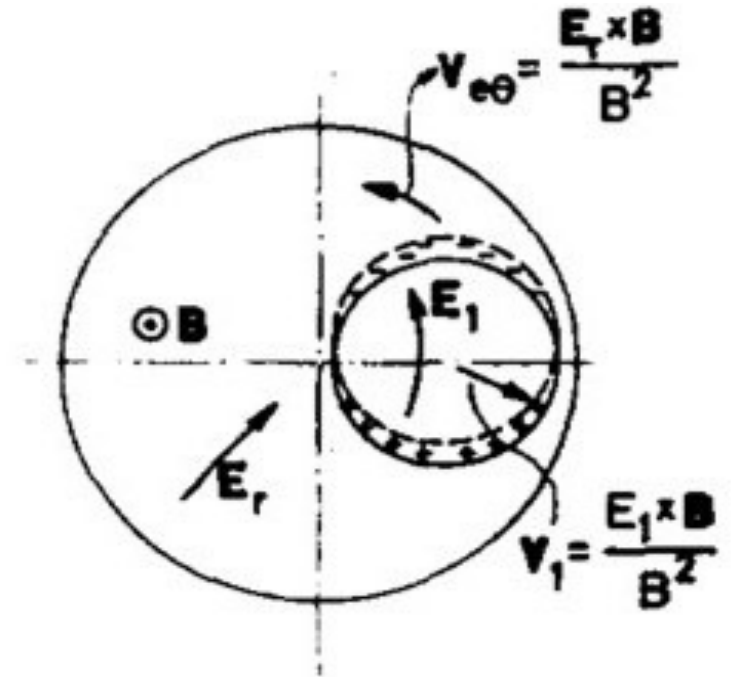

$$v_{spoke} = \frac{1}{\pi R_0} \sqrt{\frac{e E_r L_n}{m_i}} \quad L_n = \frac{n_e}{\frac{\partial n_e}{\partial r}} \quad v_{spoke} \propto \sqrt{B} \quad E_r \propto B$$



Tomography : experimental set-up

→ Instantaneous measurements, or on reproducible phenomena : spatial structure study of regular modes.

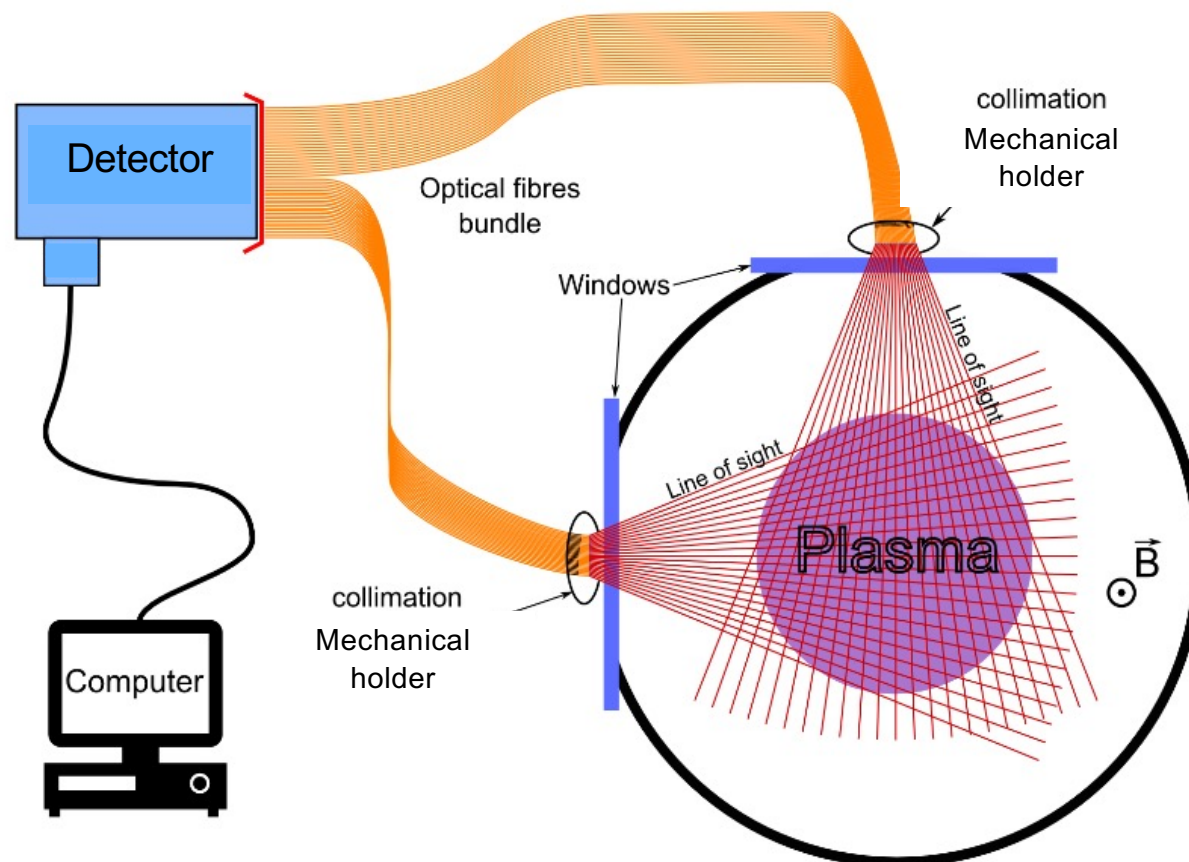

Calibration : superposition champs RF @1.25 GHz et statique

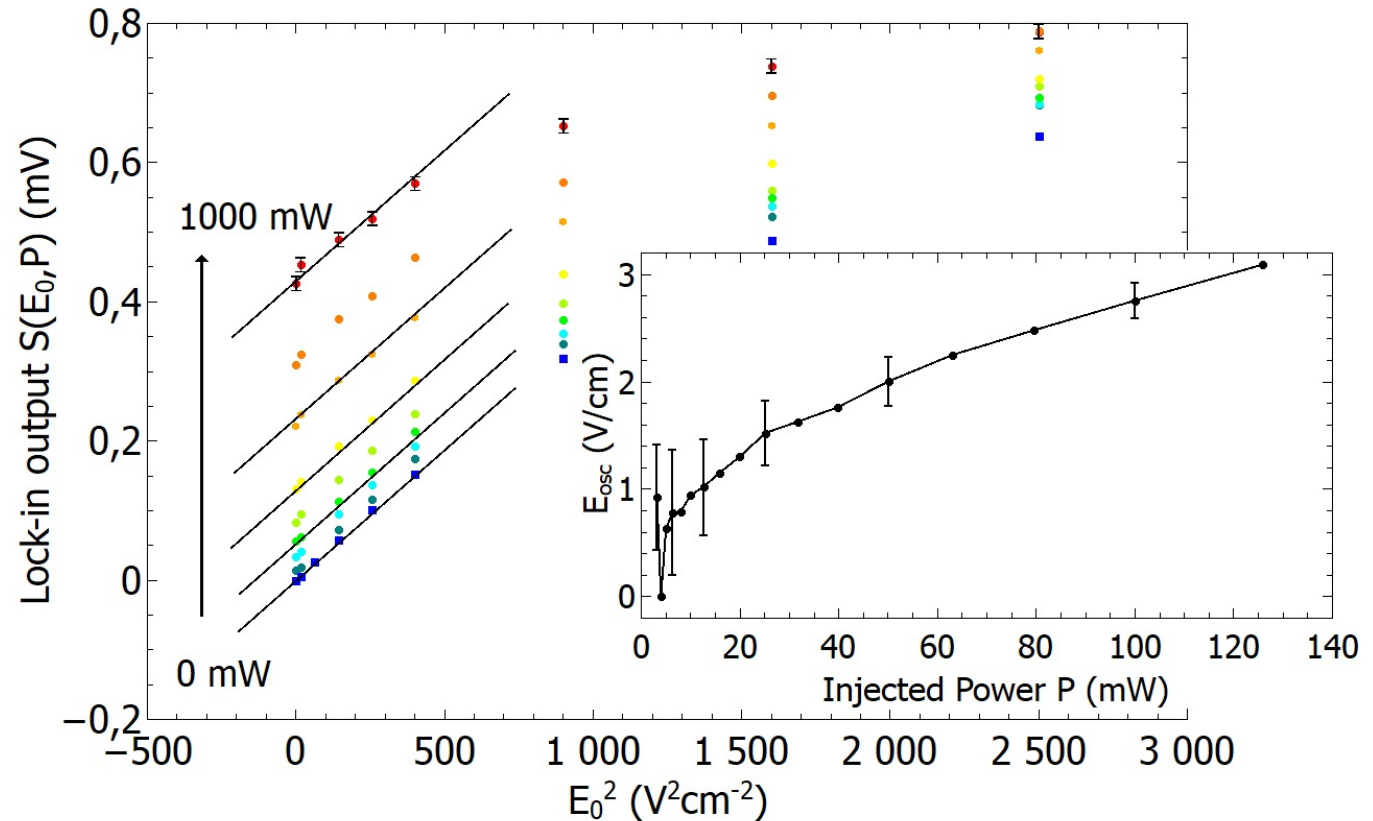

Signal non saturé :

$$S(E_0, P) \propto \gamma_{2s}^* = \beta L(0) E_0^2 + \beta L(\omega) E_{rf}^2(P)$$

Spectre Lyman alpha 10-1000 MHz

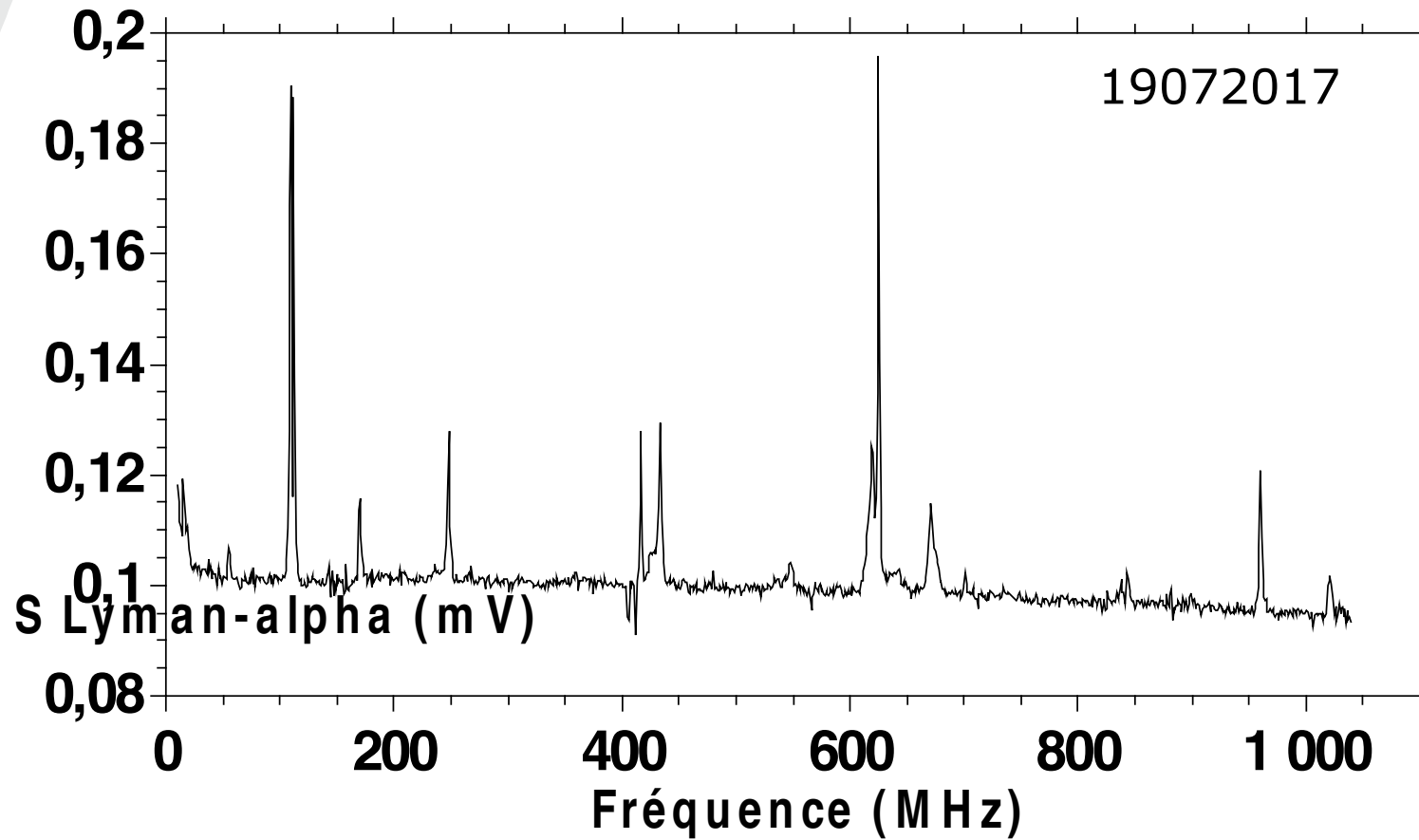

960 1020 1254 1400 MHz

