



HAL
open science

The reuniens and rhomboid nuclei of the thalamus: A crossroads for cognition-relevant information processing?

Jean-Christophe Cassel, Maëva Ferraris, Pascale P Quilichini, Thibault Cholvin, Laurine Boch, Aline Stephan, Anne Pereira de Vasconcelos

► To cite this version:

Jean-Christophe Cassel, Maëva Ferraris, Pascale P Quilichini, Thibault Cholvin, Laurine Boch, et al.. The reuniens and rhomboid nuclei of the thalamus: A crossroads for cognition-relevant information processing?. *Neuroscience and Biobehavioral Reviews*, 2021, 126, pp.338-360. 10.1016/j.neubiorev.2021.03.023 . hal-03796192

HAL Id: hal-03796192

<https://amu.hal.science/hal-03796192>

Submitted on 4 Oct 2022

HAL is a multi-disciplinary open access archive for the deposit and dissemination of scientific research documents, whether they are published or not. The documents may come from teaching and research institutions in France or abroad, or from public or private research centers.

L'archive ouverte pluridisciplinaire **HAL**, est destinée au dépôt et à la diffusion de documents scientifiques de niveau recherche, publiés ou non, émanant des établissements d'enseignement et de recherche français ou étrangers, des laboratoires publics ou privés.

The reuniens and rhomboid nuclei of the thalamus: A crossroads for cognition-relevant information processing?

Jean-Christophe Cassel ^{a,b,*}, Maëva Ferraris ^c, Pascale P Quilichini ^c, Thibault Cholvin ^d,
Laurine Boch ^{a,b}, Aline Stephan ^{a,b}, Anne Pereira de Vasconcelos ^{a,b}

^aLaboratoire de Neurosciences Cognitives et Adaptatives, Université de Strasbourg, F-67000 Strasbourg, France

^bLNCA, UMR 7364 - CNRS, F-67000 Strasbourg, France

^cAix Marseille Université, INSERM, INS, Inst Neurosci Syst, Marseille, France

^dInstitute for Physiology I, University Clinics Freiburg, 79104 Freiburg, Germany

* Corresponding author at: Laboratoire de Neurosciences Cognitives et Adaptatives, Université de Strasbourg, 12 rue Goethe, F-67000 Strasbourg, France.

E-mail address: jcassel@unistra.fr (J.-C. Cassel).

Received 8 September 2020; Received in revised form 17 March 2021; Accepted 17 March 2021

<https://doi.org/10.1016/j.neubiorev.2021.03.023>

ABSTRACT

Over the past twenty years, the reuniens and rhomboid (ReRh) nuclei, which constitute the ventral midline thalamus, have received constantly growing attention. Since our first review article about the functional contributions of ReRh nuclei (Cassel et al., 2013), numerous (>80) important papers have extended anatomical knowledge, including at a developmental level, introduced new and very original electrophysiological insights on ReRh functions, and brought novel results on cognitive and non-cognitive implications of the ReRh. The current review will cover these recent articles, more on Re than on Rh, and their contribution will be approached according to their affiliation with work before 2013. These neuroanatomical, electrophysiological or behavioral findings appear coherent and point to the ReRh nuclei as two major components of a multistructural system supporting numerous cognitive (and non-cognitive) functions. They gate the flow of information, perhaps especially from the medial prefrontal cortex to the hippocampus and back, and coordinate activity and processing across these two (and possibly other) brain regions of major cognitive relevance.

Keywords: Anatomy; Cognition; Diseases; Electrophysiology; Memory; Reuniens nucleus; Rhomboid nucleus; Ventral midline thalamus

Abbreviations: ACC, anterior cingulate cortex; Ad, adapting (neurons); AM, anteromedial nucleus of the thalamus; APV, aminophosphonovalerate; AP5, 2-amino-5-phosphonopentanoic acid; CA1, region CA1 of the hippocampus; CA3, region CA3 of the hippocampus; CAM, combined attention-memory; CB, calbindin; ChR2, channel rhodopsin 2; CMS, chronic mild stress; CNO, clozapine-N-oxide; CPFE, context pre-exposure facilitation effect; CR, calretinin; CS, conditioned stimulus; DA, dopamine; DAB, diaminobenzidine; DG, dentate gyrus; DMPP, dimethyl-4-phenylpiperazinium iodide; DPC, dorsal peduncular cortex; DREADD, designer receptor exclusively activated by designer drugs; EC, entorhinal cortex; FS, fast spiking (neurons); FST, forced swim test; HIP, hippocampus; hM4Di, modified human M4 muscarinic (hM4) receptor that couples with Gi protein; hM3Dq, modified human M3 muscarinic (hM3) receptor that couples with Gq protein; IEG, immediate early genes; ILC, infralimbic cortex; ILN, intralaminar nuclei of the thalamus; i.p., intraperitoneally; IPI, inter-pair interval (for paired-pulse stimulations); LEC, lateral entorhinal cortex; LFP, local field potential; LTD, long term depression; LTP, long term potentiation; MEC, medial entorhinal cortex; mPFC, medial prefrontal cortex; MPP, medial perforant path; MRI, magnetic resonance imaging; N2, or N200, event-related potential (ERP); NAc, nucleus accumbens; NMDA, N-methyl-D-aspartate; PD, postnatal day; PLC, prelimbic cortex; PFC, prefrontal cortex; PRC, perirhinal cortex; PRF, pontine reticular formation; PT, paratenial nucleus of the thalamus; PTD, pirithiamine-induced thiamine deficiency; PV, parvalbumin; PVN, paraventricular hypothalamic nucleus; Re, reuniens nucleus; REM, rapid eye movement sleep; Rh, rhomboid nucleus; RMP, resting membrane potential; RVLN/C1, rostral ventrolateral medulla/C1 (catecholaminergic neuron group); SLM, stratum lacunosum moleculare; SO, slow oscillations; SUM, supramammillary nucleus; SWR, sharp-wave-ripples; SWS, slow wave sleep; TTX, tetrodotoxin; US, unconditioned stimulus; VBT, ventro-basal nuclei of the thalamus; vHIP, ventral hippocampus; VMT, ventral midline thalamus; VP, ventral pallidum; vSub, ventral subiculum; VTA, ventral tegmental area; vmPFC, ventromedial prefrontal cortex; Xi, xiphoid.

1. Introduction

As the largest part of the diencephalon, the thalamus is a paired structure with about 60 nuclei in rodents, joining at the brain's midline. Classically, it gates and modulates information conveyed to and from cortical regions. Historically, its nuclei have been distinguished as 'specific', with projections to restricted cortical regions, or 'non-specific', with diffuse projections (Lorente de No, 1938). Electrophysiological arguments further supported this dichotomy (e.g., Dempsey and Morison, 1942; Moruzzi and Magoun, 1949). The non-specific thalamus contains the reticular thalamic nucleus, the intralaminar nuclei (ILN), the dorsal and ventral midline subdivisions, which include the reuniens (Re) and rhomboid (Rh) nuclei, hereafter abbreviated ReRh when considered indistinctly (Pereira de Vasconcelos and Cassel, 2015; Vertes et al., 2015).

The non-specificity of this ensemble has been challenged (Bentivoglio et al., 1991; Groenewegen and Berendse, 1994). Midline and ILN nuclei not only have cortical terminal fields with limited overlapping (e.g., Bentivoglio et al., 1991; Hsu and Price, 2007; Van der Werf et al., 2002), but also receive inputs from different brainstem regions (Krout et al., 2002). Evidence indicate that ReRh nuclei participate in functions implicating an information flow between the medial prefrontal cortex (mPFC) and the hippocampus (HIP). They are key structures in systems-level consolidation of spatial and contextual memories (Loureiro et al., 2012; Quet et al., 2020a; Ferraris et al., 2021, current issue), strategy shifting, and cognitive flexibility (Cholvin et al., 2013; see also Dolleman-van der Weel et al., 2009). They also contribute to the degree of detail with which a context is encoded (Xu and Südhof, 2013). More on cognitive contributions can be found in review papers (e.g., Cassel et al. (2013); Pereira de Vasconcelos and Cassel (2015); Vertes et al. (2015); see also Griffin (2015) for Re implications in spatial working memory, Dolleman-van der Weel et al. (2019) for a recent review of anatomical and functional features).

Important articles recently extended anatomical knowledge, including at a developmental level, original electrophysiological insights, and cognitive and non-cognitive data to the ReRh literature. We propose a synoptic overview of these contributions in filiation with previous work. Given the size of the ReRh nuclei, it is improbable that using tools like permanent lesions, pharmacological inactivation, pharmacogenetics and optogenetic approaches, either one nucleus can be manipulated without affecting functions in the other. This is important because, despite partly overlapping connectivity patterns, each nucleus has also specific connections (see Figs. 1–4 hereafter). We respected, however, the way authors have presented their work when experimental manipulations were claimed to affect either the Re or the Rh, or both (ReRh or VMT), we followed this claim.

2. Recent anatomical findings

Details on the connectivity (afferents, efferents, pathways) of the ReRh nuclei are found in previous publications (e.g., Cassel et al., 2013; Herkenham, 1978; Varela et al., 2014; Vertes et al., 2006, 2015; Xu and Südhof, 2013), and summarized in Figs. 1–4. Neurons of the Re receive information from more than 30 structures of the central nervous system (CNS). Information is sent to about the same number of structures. Dense reciprocal connections have been described between the Re nucleus and region CA1 of the HIP, as well as the anterior cingulate (ACC), infralimbic (ILC), prelimbic (PLC), and perirhinal (PRC) cortices. According to Hoover and Vertes (2012), 3–6 % (8% in Varela et al., 2014) of the neurons of the Re nucleus send collaterals to prefrontal cortex and HIP.

Connectivity of the Rh nucleus is lesser-known. The Rh receives inputs from a dozen structures – mainly from the cortex and brainstem – and sends information to about 30 structures. Reciprocal connections have also been described with region CA1 of the dorsal (not ventral) HIP (projections back to Rh are sparse), the agranular cortex, as well as ACC, ILC, and PLC cortices.

Within this connectivity network, the ReRh nuclei are ideally placed in the bidirectional information exchange between mPFC and HIP. Indeed, if HIP information can reach the mPFC by the way of direct, monosynaptic connections (Ferino et al., 1987; Hoover and Vertes, 2007; Jay and Witter, 1991; Parent et al., 2010; Swanson, 1981; Thierry et al., 2000), it is not the case the other way around (e.g. Vertes, 2004). When conveyed from mPFC to HIP, signals cross more than one synapse in a relay like the entorhinal cortex (e.g., Apergis-Schoute et al., 2006) or the ReRh nuclei (e.g., Xu and Südhof, 2013).

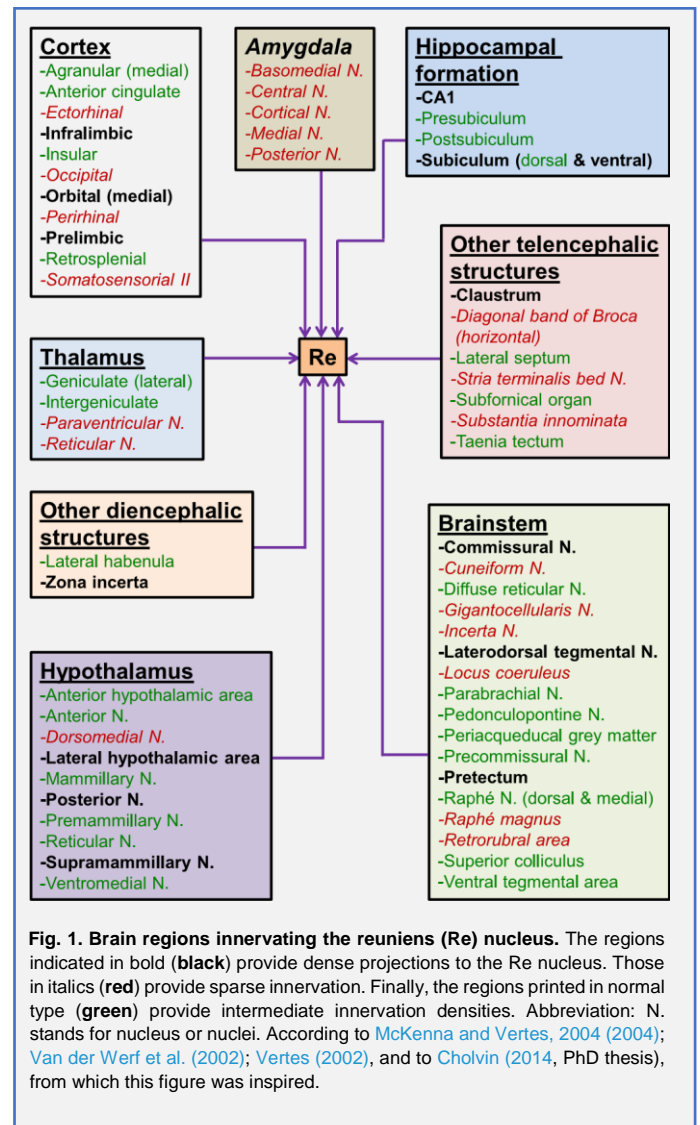

Fig. 1. Brain regions innervating the reuniens (Re) nucleus. The regions indicated in bold (black) provide dense projections to the Re nucleus. Those in italics (red) provide sparse innervation. Finally, the regions printed in normal type (green) provide intermediate innervation densities. Abbreviation: N. stands for nucleus or nuclei. According to McKenna and Vertes, 2004 (2004); Van der Werf et al. (2002); Vertes (2002), and to Cholvin (2014, PhD thesis), from which this figure was inspired.

2.1. Precisions on connectivity in the adult rodent brain

Two recent studies extended knowledge about connectivity. Mathiasen et al. (2019) compared the origins of the cortical and hippocampal projections to the mamilary bodies (MB) vs. the Re nucleus. Similarity between cognitive consequences of lesions of these nuclei and their connectivity patterns with the HIP and the PFC were two reasons to do it. Using retrograde and anterograde labelling, Mathiasen et al. found that the Re receives dense projections from the ILC and PLC (layer VI; from layer V, projections are weak), which do not project to the MB (Fig. 5). Projections from layer VI of the ACC to

the Re are dense. This layer does not project to the MB. Layer V of the ACC has weak projections to the Re and the MB. The deep neurons of the subiculum (SUB) densely innervate the Re but do not project to the MB. The superficial neurons of the SUB densely innervate the MB and have weak projections to the Re. The deep neurons of the dorsal peduncular cortex (DPC) innervate the Re densely, but weakly the MB. The superficial layer of the DPC projects to the MB densely, weakly to the Re. In this system, each subregion has a dense projection to only the Re or only the MB, and weak or no projections to the MB or Re, respectively.

This pattern could be regarded as typical of largely segregated vs. complementary connectivity systems supporting divergent functions when different, and comparable ones when overlapping. For instance, regarding memory functions, lesions of the ReRh do not impair the acquisition of a spatial task, although preventing systemic consolidation (e.g., Loureiro et al., 2012; Ferraris et al., 2021, current issue; Klein et al., 2019). Conversely, lesions of the MB or the mamillothalamic tract disrupt acquisition of a spatial memory task (e.g., Sziklas and Petrides, 1998; Vann and Nelson, 2015). Both regions, however, contribute to working memory (e.g., Santin et al., 1999; Griffin, 2015).

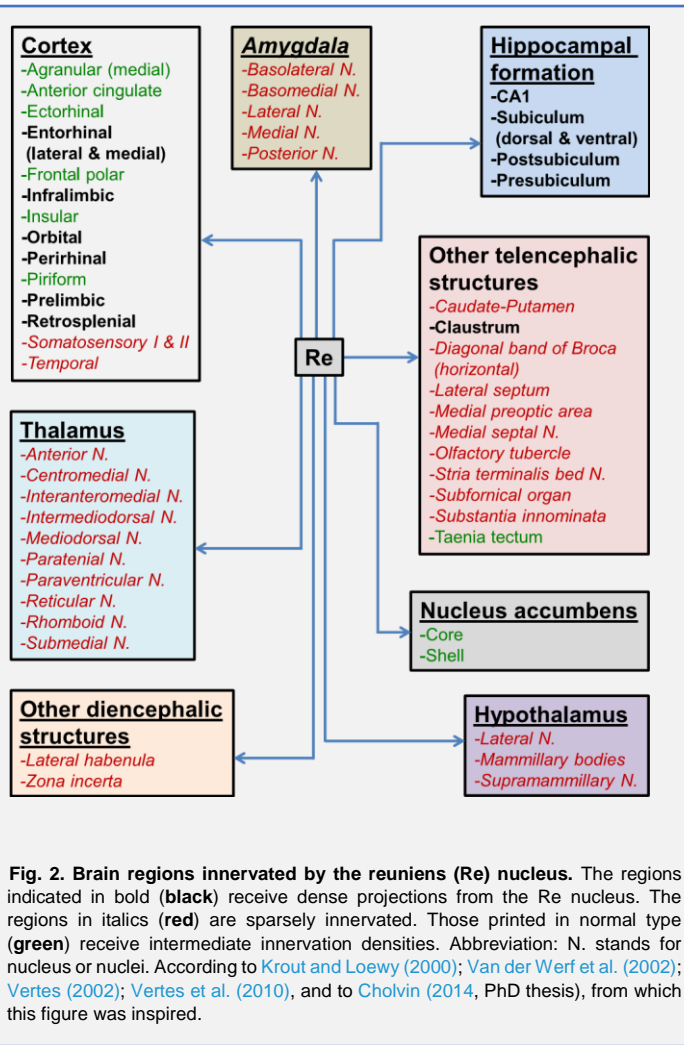

Fig. 2. Brain regions innervated by the reuniens (Re) nucleus. The regions indicated in bold (black) receive dense projections from the Re nucleus. The regions in italics (red) are sparsely innervated. Those printed in normal type (green) receive intermediate innervation densities. Abbreviation: N. stands for nucleus or nuclei. According to Krout and Loewy (2000); Van der Werf et al. (2002); Vertes (2002); Vertes et al. (2010), and to Cholvin (2014, PhD thesis), from which this figure was inspired.

The second study (Jayachandran et al., 2019) established another segregation: separate populations of mPFC neurons innervate either the Re nucleus or the perirhinal cortex (PRC). Using viral tracing and retrograde labelling, Jayachandran et al. found that mPFC neurons projecting to the Re were located in layers II/III, V and VI of mainly the ventral PLC and ILC. Those projecting to the PRC were located in layers II/III and V, not VI. All neurons

were excitatory. No neuron of the mPFC projected to both targets. These well-segregated connection patterns argue for possibly different functions originating from a common conductor. For instance, lesions of the ReRh nuclei do not impair object recognition (Barker and Warburton, 2018), when lesions of the PRC do (e.g., Nelson et al., 2016; Olarte-Sanchez et al., 2015). Interestingly, alterations in the PRC (e.g., Pezze et al., 2015) or in the PLC and ILC both perturb memory for visual objects (e.g., Ragazzino et al., 2002). This suggests that mPFC projections to ReRh most probably do not contribute to memory for object recognition.

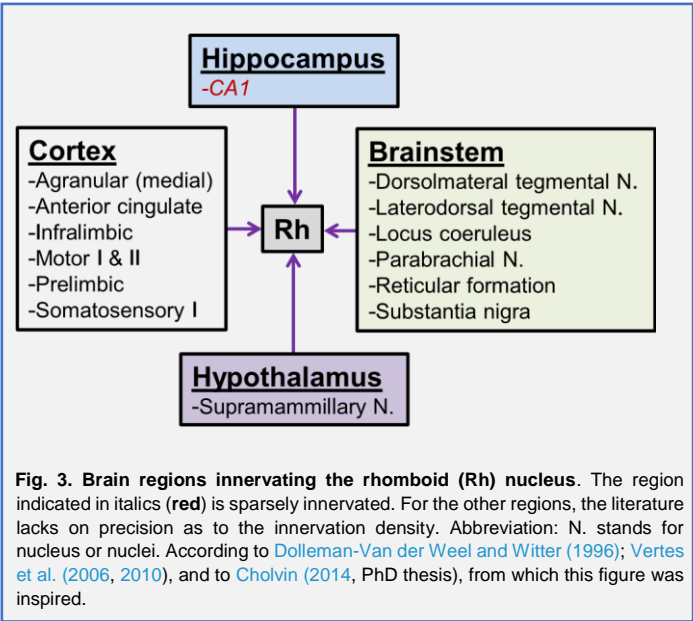
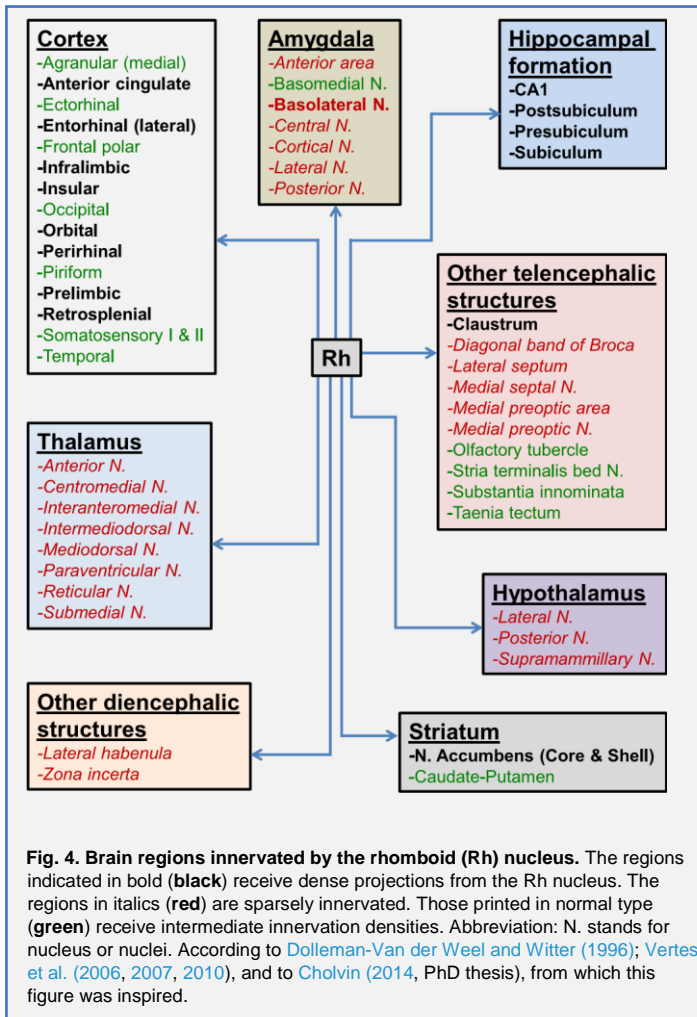

Fig. 3. Brain regions innervating the rhomboid (Rh) nucleus. The region indicated in italics (red) is sparsely innervated. For the other regions, the literature lacks on precision as to the innervation density. Abbreviation: N. stands for nucleus or nuclei. According to Dolleman-Van der Weel and Witter (1996); Vertes et al. (2006, 2010), and to Cholvin (2014, PhD thesis), from which this figure was inspired.

2.2. Connectivity pattern of Re afferents: differences between mice and rats

Most studies on the afferents of the Re nucleus were made in rats (e.g., McKenna and Vertes, 2004). Little is known about this connectivity in mice. Recently, Scheel et al. (2020) found that most Re afferents recapitulated the descriptions made so far in rats. However, some regions documented in rats were not confirmed in mice. These encompassed all divisions of the bed nucleus of the stria terminalis, the medial and lateral preoptic area, the anterior paraventricular thalamic nucleus, the lateral hypothalamic area, all nuclei of the amygdala, the lateral habenula, the dorsomedial hypothalamic nucleus, the premammillary nucleus, the substantia nigra, and the lateral entorhinal cortex. As some differences concerned the amygdala, species-specific differences on implications of Re in fear-related (and perhaps other emotion-based) behaviors might exist. If so, findings made in mice on the implication of the Re in at least fear behaviors would not necessarily be *in extenso* transposable to rats, and *vice versa*.

Although similar on some aspects (e.g., Blanchard et al., 2001), fear and defense behaviors in response to an animate threat, whether a conspecific or not, may also show species-related differences. For instance, when confronted to a vital threat, rats and mice respond differently. Rats emit ultrasonic alarm vocalizations intended to alert their colony. Mice do not. Rats are more colonial than mice (Kondrakiewicz et al., 2019). It is therefore possible that projections of the amygdala to the Re in rats permit more elaborated responses to threat by the way of a wider distribution of amygdala-generated emotional signals, which, after a relay/integration in the Re, could be conveyed to other structures, including those involved in alarm signaling. In mice, which are more solitary animals (Kondrakiewicz et al., 2019), defense responses could be more direct and require less information sharing or relaying between the amygdala and other brain structures.



populations in dorsal and dorsolateral areas. CB+/CR + were mostly found along the lateral and ventral borders of Re; amounting 55 % of CR + cells and 41 % of CB + cells. In the Rh, few CR + cells were present, mostly localized to medial part of the nucleus. CR+/CB + cells amounted 50 % of CR + and 9% of CB + cells.

In the caudal level, the ventral part of the Re contained no CB + or CR + cells, but a network of CR + fibers was close to the third ventricle, spreading over this region, along with few CR + cells located laterally. There were few CR + cells in periRe mostly along the lateral borders and strongly overlapping with CB + cells. The latter were abundant in the periRe. CR+/CB + cells accounted for 65 % of CR + cells and 58 % of CB + ones. In the caudal Rh, CB + cells were numerous and located in the lateral wings, while CR + were largely absent. CR+/CB + cells amounted 31 % of CR + and 9% of CB + cells. Finally, Viena et al. showed that Re neurons monosynaptically projecting to both the HIP and mPFC do not express CB or CR, but are surrounded by rings of CR+, CB + or CB+/CR + cells. This cell population might participate in the synchronization of oscillations and communication in the mPFC-HIP memory system (Dolleman-van der Weel et al., 2019).

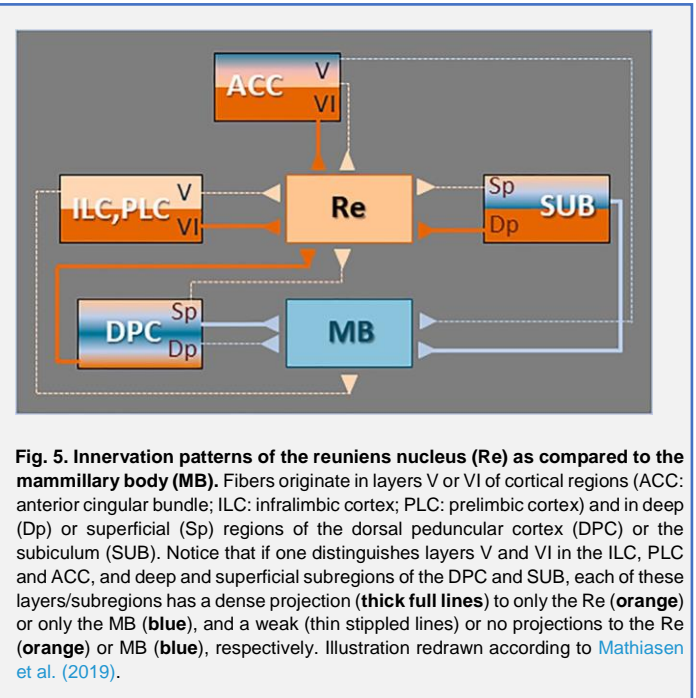

2.3. Calretinin and calbindin expression in the ReRh

Previous data showed that the Re contained numerous calretinin (CR) and calbindin-D28k (CB) neurons with a similar distribution for both proteins. There is less of such proteins in the Rh. There are no parvalbumin(PV)-positive cells in the Re and Rh (Arai et al., 1994; Bokor et al., 2002; rev Cassel et al., 2013). These proteins are key regulator of Ca⁺⁺ homeostasis and are involved in extra- and intra-cellular functions such as synaptic Ca⁺⁺ signaling. In some brain areas (e.g., HIP, neocortex), CR and CB are molecular markers of discrete GABAergic neurons (e.g. Freund and Buzsaki, 1996; Kubota et al., 2011).

Two recent papers presented a detailed map of the localization of CR + and CB + neurons in the midline thalamus, including the Re and Rh nuclei, their specific connections with the HIP and mPFC (Viena et al., 2020), and their role during HIP oscillations (Lara-Vasquez et al., 2016). The paper by Viena et al. (2020) investigated the distribution of PV, CR and CB, exploring the Re population projecting to the HIP and mPFC.

In the rostral level, CR+, CB + and CR+/CB + neurons were clustered in defined zones, with CR + in the dorsal, middle and ventral regions, CB + throughout the entire Re, and more packed and separated from CR + cells in the dorsolateral regions. In dorsal and medial Re, CR + and CB + were distributed throughout, and cell size was largest in the dorsolateral regions. Dual-labeled CR+/CB + cells represented about 55 % of CR + cells and about 40 % of CB + cells.

In the mid-levels, Re and Rh showed different patterns: the Re CR + cells were abundant with a slight shift in location ventrally and laterally vs. the rostral level. CB + cells were localized throughout Re with independent

A summary of the quite complex distribution of CR+, CB + and CB+/CR + in the Re is shown in Fig. 7 of the article by Viena et al. At a functional level, the authors proposed that these detailed CR + and CB + topographies might represent separate thalamo-cortical circuits. CB + cells are found throughout the midline thalamus with terminals in the superficial cortical layers and involved in processing information from multiple brain regions (rev Cassel et al., 2013; Dolleman-van der Weel et al., 2019; Pereira de Vasconcelos and Cassel, 2015; Vertes et al., 2015). Knowledge about the role of CR + cells is too sparse to enable any speculation. The description of these different subpopulations of neurons in the Re extends a former report by Arai et al. (1994) and calls for more investigation of the functional contributions of each neuronal subpopulation, which could belong to microcircuits associated with distinct rhythmicity and synchronizations (e.g., theta, gamma, sharp-wave ripples). It is perhaps time, therefore, to give up considering the Re as a relatively homogeneous functional entity made of mainly glutamatergic neurons with overall excitatory functions. Viena et al. (2020) further supported (Hoover and Vertes, 2012; Varela et al., 2014) that Re neurons projecting collaterals to both the mPFC and HIP constitute a clearly distinct neuronal

ensemble that could have a *sui generis* function, perhaps that of providing, in parallel and/or synchronized ways, the same information to both target structures.

2.4. Re dopaminergic neurons and the paraventricular nucleus-rostral ventrolateral medulla/C1 circuit

Ogundele et al. (2017) described, in mice, a small population of dopaminergic neurons (DA) in the Re and the zona incerta (ZI). Tyrosine hydroxylase (TH)-positive cells were counted in the Re, paraventricular nucleus (PVN) and ZI. Re dopaminergic neurons are mostly bipolar (80 %) with angulated cell bodies. Some of them project from the lateral part of the Re to its contralateral one, bidirectionally. The authors proposed that these thalamic DA neurons regulate activity in the hypothalamic PVN- rostral ventrolateral medulla (RVLM)/C1 circuit. This circuit controls various physiological functions such as body energy balance and response to acute stress (Bell et al., 2000). Given the implication of the RVLM in the regulation of vasomotor tone and of the mPFC-Re connection in defense behavior (see 4.8.4.), it is not impossible that these dopaminergic projections from the Re to the PVN vehicle information enabling the RVLM to adapt the vasomotor tone to a threatening situation or an imminent behavioral response to it.

2.5. ReRh nuclei and postnatal connectivity development

In a recent study, Hartung et al. (2016) investigated, in neonatal rats, the interplay between the mPFC and the HIP. They focused on the PLC, which is the rostral region of the mPFC receiving the strongest hippocampal drive. Because this interplay is well described in adults (e.g., Igarashi et al., 2014; Morales et al., 2007), Hartung et al. especially focused on how it emerged early in life. Brockmann et al. (2011) showed that axonal projections from HIP to PLC exist at the end of the first postnatal week, and that no direct projections back to the HIP are detected at this age (but also later; see e.g., Takagishi and Chiba, 1991; Vertes, 2004). Using Fluoro-Gold, Hartung et al. examined the connectivity among structures of interest (tracer injected at PD1 and/or PD5) and described projections from ReRh (VMT) to PLC and HIP, from HIP and PLC to VMT, and from LEC to HIP and PLC (see Fig. 6). Conversely to observations in adult rats (Kerr et al., 2007), projections from PLC or HIP to LEC were not found, indicating their establishment at a later developmental stage.

Thus, most of the connectivity described in adult rats is present as early as after one postnatal week. Interestingly, functional characteristics of this circuit have been investigated recently by electrophysiological tools in neonates (Hartung et al., 2016) and adults (Dolleman-van der Weel et al., 2017). It is difficult to believe that this circuit operates in neonates as it does in adults (sensory inputs, motor possibilities, and maturation stages of neocortical structures are much too different). Noteworthy, however, is that the presence of this circuit at such an early age is compatible with the idea that activations therein, whatever the profile, could contribute to a progressive, post-birth stabilization of the connectivity. This stabilization could be necessary to the postnatal emergence of cognitive functions implicating the ReRh nuclei. Indeed, it is known for long that neonatal activity in central nervous system pathways is crucial for a normal consolidation of connections (Bower, 1990), which start to establish before the function's emergence. This might be true for spatial memory functions, which emerge during or slightly after the second postnatal week in rats (e.g., Baram et al., 2019; Tan et al., 2017). For instance, allocentric memory emerges around PD16, place cells are there at about the same moment, boundary and grid cells just a couple of days later (Baram et al., 2019; Bjerknes et al., 2018; Tan et al., 2017). Interestingly, cells such as place cells, head direction cells, and boundary cells have been described in the Re nucleus of adults (see below). Oscillations of the theta or gamma type also appear at a very early stage (Tan et al., 2017), and the Re is known to play a role in their coherence, at least in adults (see below).

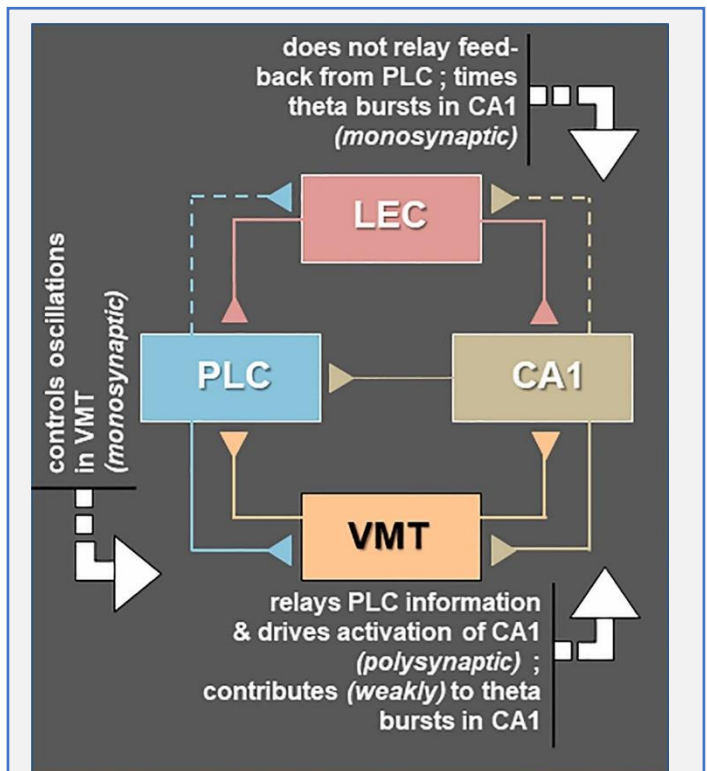

Fig. 6. Cortico-thalamo-hippocampal connectivity patterns in the neonatal rat. Solid lines indicate the connectivity between the lateral entorhinal cortex (LEC), the prelimbic cortex (PLC), the ventral midline thalamus (VMT) and region CA1 of the hippocampus, as described in Hartung et al. (2016) in the neonatal rat. The hatched lines were described in adults (Kerr et al., 2007), but could not be evidenced in neonates. Notice that there are no direct projections from the PLC to CA1, confirming older and more recent findings (Fillinger et al., 2017; Jay and Witter, 1991; Xu and Südhof, 2013). Greyish arrow heads indicate directionality. Redrawing according to Hartung et al. (2016).

3. Recent electrophysiological findings

Given the connections between the ReRh and both the mPFC and the HIP, it is reasonable to expect that the ReRh nuclei influence cortical and hippocampal functions, and that, in return, these structures influence activity in the ReRh. First evidence supporting an influence of midline thalamic nuclei on the activity of cortical regions was reported almost 80 years ago (Dempsey and Morison, 1942; Morison and Dempsey, 1942). More recently, Viana Di Prisco and Vertes (2006) reported that stimulations of the Re nucleus induced large amplitude evoked potentials in the PLC. The recorded N2 deflection corresponded to excitatory evoked potentials at monosynaptic latencies, compatible with a direct excitatory projection from Re to the mPFC. Furthermore, the authors reported on paired-pulse facilitation induced by Re stimulation, with the largest changes in the ILC (+83 %) and PLC (+75 %) cortices, comparable to those observed in the dorsal HIP (+62 %). Eleore et al. (2011) also found paired-pulse facilitation in the mPFC by Re stimulation in mice.

There was also evidence for a contribution of Re to hippocampal function. Hirayasu and Wada (1992a,b) reported that intra-Re infusions of *N*-methyl-D-aspartate (NMDA) induced EEG discharge patterns in the HIP characteristic of generalized limbic seizures; hippocampal kindling was also observed. Furthermore, selective pharmacological blockade of thalamic midline nuclei suppressed limbic seizure activity in a model of CA3 kindling (Bertram et al., 2001), and this was accompanied by neuronal loss in the ReRh. However, none

of these studies explicitly showed a direct influence of the ReRh on hippocampal activity.

Dolleman-Van der Weel et al. (1997) were the first to propose an anatomical-functional model in which Re neurons monosynaptically (when rostral) or disynaptically (when caudal) have an excitatory influence on CA1 pyramidal neurons via synapses on apical dendrites at *stratum lacunosum moleculare* (SLM). Other Re afferents to CA1 might synapse on dendrites of inhibitory interneurons and then extend branches from *stratum radiatum* to SLM to exert an excitatory influence, which, together, would result in dual inhibitory/excitatory actions on CA1 pyramidal cells. A final population of hippocampal interneurons influenced by the Re was located in the alveus and *stratum oriens*, which exerted feed forward inhibition on pyramidal cells when activated. Via the subiculum, pyramidal neurons project back to the Re, thereby closing a functional loop, which has been prevised in the 2019 review by Dolleman-Van der Weel et al. In this loop, Re activity may i) modulate CA1 activity and/or ii) be modulated by information from the HIP. Bertram and Zhang (1999) showed that Re or CA3 stimulation had excitatory effects on CA1 neurons, with shorter response latencies after Re than after CA3 stimulation. High frequency stimulation of the Re, but not CA3, induced LTP in CA1. These findings show that Re and CA3 exert independent effects on CA1 neurons. Re stimulation elicited shorter-latency potentials at CA1 during theta activity (spontaneous or tail pinch-induced) compared to non-theta states, and Re neurons showed a marked increase in rate of discharge before or after theta periods as opposed to non-theta periods (Morales et al., 2007).

All these studies have shed light on how Re or Rh affects cortical and hippocampal functions. Recent experiments have added to this knowledge by the way of *ex vivo/in vitro* approaches focusing on particular circuits, and of local field potential or single unit recordings in either anesthetized or awake rodents.

3.1. Ex vivo/in vitro electrophysiological experiments

3.1.1. Firing properties of Re neurons in mice

In brain slices of C57-BI/6 male mice (age 14–18 weeks), Walsh et al. (2017) recorded the activity of rostral Re neurons (loose-patch, cell-attached, whole cell mode). Their average resting membrane potential (RMP) was of about -64

3.1.2. Arousal driven by the Rh is potentiated by an orexin-gated excitatory feedforward loop in the cortex

Using rat brain slices, Hay et al. (2015) explored the role of the neocortical layer VIb (parietal cortex) in the modulation of arousal by combining patch-clamp recording and optogenetics. These authors built on the facts that i) layer VI receives dense projections from the *non-specific* thalamus (e.g., Herkenham, 1980), ii) the role of layer VI in thalamocortical activity during sleep/wake cycle is critical, notably via wake-promoting neurotransmitters such as acetylcholine (Kassam et al., 2008), and iii) layer VIb is the only cortical lamina reactive to orexin; it is also sensitive to acetylcholine acting on nicotinic receptors (e.g., Bayer et al., 2004). Hay et al. first showed that pyramidal neurons from cortical layer VIb were excited by a nicotinic agonist, as well as by orexin, and that a low concentration of nicotine potentiated the effect of orexin. By the way of viral transfection, neurons of the Rh were brought to the expression of channel rhodopsin2 (ChR2). When the ChR2-bearing fibers arising from the Rh were photostimulated, the spike-timing precision of the neurons from layer VIa were increased by application of orexin to layer VIb. The authors conclude that the cortical layer VIb could be an orexin-gated excitatory feedforward loop potentiating arousal driven by the Rh.

3.1.3. Rh regulates contextual information inputs into parietal cortex receiving sensory inputs

mV. During the 60 first seconds of the whole cell mode, most neurons (88 %) fired one or more spontaneous action potentials, but activity was lost rapidly in about 20 % of them. In most of the others, the resting membrane potential (RMP) was of -61.4 mV, the average firing frequency of 9.2 Hz, with about 2/3 of neurons firing in the 4– 10 Hz range. Recordings made under blockade of AMPA/kainate, NMDA and GABA_A receptors neither abolished the spontaneous firing (69 % cells were still active) nor affected the discharge frequency in dramatic ways (mean frequency =8 Hz), indicating that action potential firing *in vitro* relied on properties of the neurons, not on synaptic inputs. When the membrane potential was forced to - 80 mV and short depolarizing currents were injected, two types of neurons were identified: some with one action potential at their rheobase, others with up to six. Blockers had no effect on rheobase values. These neurons showed diverse firing patterns, some with an initial burst of firing at 115– 145 Hz, which then decreased to 10– 30 Hz, others lacking this initial burst and showing a more regular pattern of firing. With a membrane potential held at - 72 mV and current injections, initial bursts were seldom observed.

Part of these characteristics suggest the presence of T-type Ca²⁺ channels, which have a low activation threshold and are inactivated at a slightly depolarized resting potential. Walsh et al. (2017) could demonstrate that T-type Ca²⁺ channels were implicated in the ability of Re neurons to generate a very high frequency of action potentials (> 300 Hz) after these neurons had rested at a negative potential (ca. - 80 mV) for a short period of time. This burst firing potential could be eliminated by prior application of a theta-burst firing protocol, which resulted in a 6 mV hyperpolarization gain of the membrane potential. From this very descriptive work, which is the first of that type, one can retain that the resting potential of Re neurons might determine how these neurons communicate with their targets: i) a tonic firing for cells around - 65 mV, ii) single spikes or a period of low-frequency regular spiking for neurons resting more depolarized than - 72 mV, and iii) robust multispikes bursts on activation for Re cells at - 80 mV or below. Given that the firing pattern of Re neurons is determined by the value of their resting potential when receiving depolarizing extrinsic influences, it is possible that these neurons do more than just relay information. Although these observations were made *in vitro*, and certainly call for additional *in vivo* challenges, they could reflect integrative activity possibilities in the Re.

More recently, Hay et al. (2019) investigated the mechanisms by which the cerebral cortex performs sensory detection and integration. ChR2 was expressed in neurons of the Rh nucleus and in the ventro-basal nuclei of the thalamus (VBT). To the parietal association cortex, the Rh conveys contextual information when the VBT conveys sensory information. The maximal innervation density from the Rh is in layers VI and I, and the maximal innervation from the VBT in layer IV. Photostimulation of the VBT induced inhibitory and excitatory post-synaptic currents in layer IV that reflected shorter recurrent activity than after Rh photostimulation. Hay et al. established that Rh inputs activated adapting (Ad) interneurons and had weak connections with fast-spiking (FS) interneurons. Conversely, inputs from the VBT showed the opposite pattern, namely weak connections with Ad interneurons and stronger ones with FS interneurons. The authors then compared the recruitment of FS and Ad interneurons induced by VBT and Rh photostimulation. Photostimulation induced action potentials in FS interneurons, but faster for VBT than for Rh inputs, compatible with direct vs. indirect influence, respectively. Regarding Ad interneurons, spikes were elicited by photostimulation of the Rh in most (66 %) of them, but seldom so (<10 %) by stimulation of the VBT. These functional differences have consequences on the inhibition of layer VI pyramidal neurons, in which the response was faster after VBT stimulation than after Rh stimulation. In fact, FS interneurons are involved in the time limitation of the cortical response to thalamic inputs. Conversely, Ad interneurons are implicated in prolonged cortical responses to Rh inputs. By doing so, these mechanisms tune cortical

responses to thalamic inputs in a way enabling summation of sensory (via VBT) and contextual (via Rh) inputs.

These experiments show that Re neurons have functional properties compatible with information integration, and not simply a relay role, and that Rh neurons convey context-related information to cortical modules that can be combined to sensory inputs there.

3.2. In vivo experiments in anesthetized rodents

3.2.1. Connectivity between HIP, LEC, PLC and ReRh is operational as early as 1st postnatal week in the rat

Hartung et al. (2016) collected multiunit activity and local field potentials in the HIP, LEC, PLC and VMT of newborn rats. Recordings were performed under light urethane anesthesia, a condition generating activity close to that of non-anesthetized asleep rats (e.g., Bitzenhofer et al., 2015). The analyses focused on neuronal activity coupling with theta oscillations. Lidocaine was used to inactivate the PLC or the VMT. Hartung et al. found that during the first postnatal week, the LEC exhibited discontinuous network activity in the theta band (mean =7.4 Hz), which was interpreted as theta bursts. Most of these bursts co-occurred with hippocampal bursts, explaining a high spectral coherence between the two structures. Individual neurons discharged at their highest frequency during theta bursts and these discharges occurred shortly before the peak of the theta cycle.

The ReRh nuclei also showed coordinated network oscillations episodes in the theta band (mean =6.05 Hz), although less frequently than LEC theta bursts. Spectral coherence analyses found the tightest coupling between PLC and VMT. The firing of ReRh neurons occurred during, but was not phase-locked with, theta bursts. Thalamic theta bursts always co-occurred with PLC or hippocampal ones. When the PLC was blocked by lidocaine infusion, theta bursts decreased in the PLC (by about 67 %) and ReRh (by about 63 %); the HIP was affected when the inactivation magnitude of the PLC exceeded 70 %. When the ReRh were inactivated, their theta bursts were reduced by about 50 %, a change that affected the PLC and the HIP, where the oscillatory events were decreased. Altogether, these data show that as soon as 1 postnatal week, oscillatory theta-like activity bursts entrain the LEC and the VMT. Whereas the main communications of the LEC are with the HIP, where it has facilitating effects on the emergence of theta bursts, the ReRh nuclei relay feedback from the PLC to the HIP, where they drive activation. Thus, very early in the course of postnatal development, the ReRh nuclei take their relay place in the circuitry which, later on, participate in a range of cognitive processes (e.g., working memory, detail encoding, systems-level consolidation, and strategy adjustments; see Cassel et al., 2013; Griffin, 2015; Pereira de Vasconcelos and Cassel, 2015; Vertes et al., 2015). It is highly probable that this communication contributes to the development of the connectivity and of the functionality that are typical of an adult brain (e.g., Bower, 1990; end of section 2.5).

3.2.2. HIP to mPFC and mPFC to HIP communication is relayed by the Re in adult rodents

Recently, in adult male rats subjected to a sham-operation or NMDA-induced lesions of the Re, Kafetzopoulos et al. (2018) recorded local field potentials in the PLC and ventral CA1/subiculum region under pentobarbital anesthesia. Lesions had no effect on the overall activity, whatever the region and the frequency band (i.e., delta, theta, beta, low gamma or high gamma). However, Re lesions reduced coherence between PLC and HIP in the theta and beta frequency bands. Roy et al. (2017) further characterized this circuitry in urethane-anesthetized rats. Until then, most studies focused on coherence at theta frequency (4– 8 Hz), the HIP being considered the synchronizing source. The HIP-PFC coupling involves another rhythm, in which the PFC is the synchronizing source (Fujisawa and Buzsaki, 2011). This rhythm co-occurs with hippocampal theta and is in the 2– 5 Hz band. Unlike delta activity (1– 4 Hz), it is regular.

Roy et al. implanted recording devices in the HIP, the Re and PLC. A stimulating device was placed in the pontine reticular formation (PRF). With PRF stimulation, the 4 Hz 'urethane' hippocampal theta shifted to 4– 10 Hz, as also induced by tail pinching. Hippocampal theta was elicited by PRF stimulations at variable intensities and Re was inactivated by lidocaine (200 ng in 1 μ L). In the HIP, without PRF stimulations, there were alternations of irregular activity and theta episodes. In the PFC, irregular activity alternated with a regular rhythm at about 2 Hz that co-occurred with HIP theta. Both HIP theta and PFC rhythms were also recorded in the Re nucleus. In response to PRF stimulation, the 2– 5 Hz oscillation was dominant in the PFC, the theta oscillation was dominant in the HIP, and both oscillations were found in the Re nucleus. Augmenting stimulation intensity linearly increased the peak frequency of both types of oscillations and synchronized theta in all three regions. In addition, the stimulation increased the peak power for theta activity in the HIP, but decreased it for the 2– 5 Hz oscillation in the three structures. With both rhythms, Roy et al. observed a strong correlation between the Re and both other structures, the largest correlation being for the 2– 5 Hz oscillations with the PFC, and for the theta rhythm with the HIP.

Lidocaine inactivation of the Re had little influence on the coherence between PFC and HIP theta, compatible with the monosynaptic connection between the HIP and the PFC, and with the HIP being the driver of theta in the PFC. Conversely, the coherence between the HIP and the PFC in the 2– 5 Hz band was reduced by Re nucleus inactivation. Taken together, these data indicate that communication from the HIP to the PFC occurs at theta frequency via direct projections, whereas the communication from the PFC to the HIP occurs at 2– 5 Hz frequencies, using the Re nucleus as a relay. An alternative hypothesis regarding this second rhythm would be that it is not generated in the PFC but in another structure such as the ventral tegmental area (VTA) or the Re nucleus itself.

Ferraris et al. (2018) have tried to understand how hippocampo-prefrontal coupling (important for memory consolidation) is influenced by the Re nucleus. In urethane-anesthetized rats, they recorded local field potentials in CA1, PLC and Re. Data were collected during alternating slow and theta oscillation periods, which looked like oscillations of SWS and REM sleep, respectively. During slow, not during theta oscillations, CA1 and mPFC LFPs correlated in the gamma band (30– 90 Hz), and gamma power underwent modulation by the slow oscillation phase: all gamma bursts were phase-locked to the slow oscillation in a window spanning the trough and ascending phase. Similar observations were made during natural SWS. There was no correlation between CA1 and mPFC during theta oscillations. More than half HIP and mPFC neurons were entrained by gamma oscillations, but their activity was comparable during synchronized and non-synchronized bursts, suggesting that they are not determinant in the CA1-mPFC synchronization process.

Ferraris et al. then showed that neurons of the Re increased their firing rate about 100 ms before the onset of the synchronized gamma bursts. The Re neurons were also entrained by the slow oscillation phase. These findings are compatible with a role of Re neurons in information circulation between CA1 and mPFC, as confirmed by inactivation of the Re. When muscimol was infused into the Re, the modulation of the gamma power by slow oscillations was reduced and phase-shifted, the correlation between hippocampal and cortical LFPs was diminished, as was the co-occurrence of the gamma bursts between both structures. Re inactivation also reduced the firing frequency of mPFC not of HIP neurons. These data point to a role for Re neurons in the control mPFC firing, in gamma burst synchronization between CA1 and mPFC, and in coordinating neuronal activity between the two structures. Because neurons of the Re increase their firing rate before CA1-mPFC gamma burst coupling, the Re could be the driver. This interpretation is challenged by a report by Hauer et al. (2019), who proposed that the mPFC entrains the Re, which in turn entrains the HIP, thereby enabling slow oscillations coupling. Recordings showed that the activity of single neurons in the Re was correlated with the slow oscillations (SO) in the mPFC during HIP theta-off phases.

During HIP theta-on phases, the Re neurons exhibited high frequency firing patterns. The correlation between neuronal firing in the Re and SO in the mPFC was confirmed using multi-unit signals recording. When Re neurons were

stimulated optogenetically, a large negative potential was recorded in CA1, with a maximal amplitude at the SLM level. The same response was obtained after stimulation of the cingulate bundle, where projections fibers from Re to CA1 are coursing. Next, Hauer et al. used a paired-pulse stimulation paradigm to record the response of the HIP to stimulations of the ILC or PLC regions of the mPFC. The stimulation of the ILC produced excitation in the Re and a hippocampal-evoked potential that was similar to the consequence of Re or cingulate bundle stimulation. In rats with hM4Di-expressing Re neurons, the i.p. administration of CNO produced a substantial decrease of the hippocampal response to paired-pulse stimulations of the ILC. The coherence of the slow oscillations between mPFC and HIP was reduced following CNO injections. Altogether, these data show that connections between the mPFC and HIP enable the coherence of slow oscillations in these two structures, and that neurons of the Re have a crucial interfacing relay- role as they potentially transmit slow oscillations from the mPFC to the HIP.

Lara-Vasquez et al. (2016) recorded action potentials of individual neurons and labeled them according to their expression of CR and/or CB. Single cell activity from the midline thalamus was recorded and LFP from the HIP (CA1 *stratum pyramidale*) during HIP spontaneous activity (baseline condition), HIP theta oscillations (4– 8 Hz), and sharp-wave-ripples (SWR, 2– 3 Hz). These 2 types of oscillations are associated to memory encoding and episodic memory consolidation, respectively. During spontaneous activity, i) approximately 50 % of the labeled neurons were CB + or CR + across the midline thalamus and nearly 50 % of labeled neurons co-expressed both markers and ii) CR + neurons exhibited low levels of spontaneous activity with a higher proportion of burst discharges, as compared to CR- neurons. During HIP theta oscillations, both CB + and CB- neurons tended to discharge more; CR + neurons did not change their firing rate and were not strongly recruited by the oscillatory episodes. Conversely, CR- neurons were more active in general during both theta- and non-theta oscillations. In addition, only a fraction (about 1/3) of CR- neurons activity was phase coupled to the oscillatory cycle and these theta-modulated cells were widely distributed along the dorsoventral axis of the midline thalamus.

They were not associated to any specific nucleus.

Finally, during HIP sharp-wave ripples, CR- neurons did not change their firing rate probability, while the spike timing of CR + neurons was significantly modulated by SWR, i.e., inhibited during the SWR and activated right before and right after the SWR. This study showed for the 1st time that the physiological properties of midline thalamic neurons can be defined by their expression of calcium-binding proteins, particularly CR, rather than by their anatomical location. CR + neurons are likely to be glutamatergic projection neurons. The authors propose the existence of a functional link between the midline thalamus and HIP oscillations during different stages of memory processing, with CR- neurons activated by theta oscillations (during memory encoding) and CR + neurons inhibited by SWR (during memory consolidation). This study comforts the implication of the midline thalamus in memory processes (see below, section 4), with a function-specific engagement of various subclasses of neurons expressing calcium-binding proteins.

3.3. In vivo experiments: awake and behaving rodents

3.3.1. Information transfer from mPFC to CA1 and its modulation

During a spatial working memory task, oscillatory activity between mPFC and HIP is coupled (Hyman et al., 2005; Jones and Wilson, 2005). Hallock et al. (2016) explored the cortico-hippocampal interactions during a T-maze working memory task using a spatial vs. a non-spatial protocol in rats. Tetrodes implanted into the mPFC or CA1 collected single unit activity and local field potentials. Rats performed both tasks with similar efficacy. Recordings showed that, while rats are waiting in the start box, the HIP sends information to the mPFC in the theta-frequency band. When rats cross the choice point, the mPFC sends information to the HIP in the slow gamma-frequency band (30– 80 Hz). The information arising in the mPFC cannot monosynaptically reach CA1. The

authors therefore tested the effects of muscimol infused into the Re on behavior and electrophysiological activity. Muscimol impaired task performance, reduced single unit firing rate in the mPFC, and decreased the number of neurons phase-locked with hippocampal theta. It also decreased the HIP-mPFC theta-gamma coupling during choice-point traversal. Re inactivation, however, did not affect theta-gamma coupling in the HIP or mPFC during stem traversal or start box occupancy. These observations confirm that good performance in this working memory task requires a Re-orchestrated modulation of HIP-mPFC synchrony.

Ito et al. (2018) recorded neuronal activity in rats running a similar alternation task in a modified T-maze. In the stem of the maze, rats prepare their upcoming trajectory choice (i.e., go right or go left at choice point), not in the side arms leading them back to the start. Recordings of mPFC neurons and LFP in CA1 showed enhanced phase locking between mPFC spikes and CA1 theta when rats approached the choice point. Enhanced phase locking occurred without modifications of mPFC firing rates between stem and non-stem parts of the maze. The activity of Re neurons was then recorded along with hippocampal LFP, and in the stem, spike-field coherence was enhanced in the theta band as compared to non-stem locations of the rats. Thus, the activity of mPFC and Re neurons is coordinated with theta rhythm in CA1, suggesting information transfer from mPFC to CA1 via Re neurons. Because the supramammillary nucleus (SUM) of the hypothalamus has projections to the mPFC and Re, and to both CA2/CA3 and dentate gyrus of the HIP (rev Vertes et al., 2015), neuronal activity was also recorded in the SUM. About 70 % of SUM neurons showed phase modulation to CA1 theta, and about half of them were firing in the theta frequency. This firing was not significantly influenced by the trajectory (stem vs. non stem). However, the SUM-CA1 coherence was enhanced on the stem in the theta frequency band.

Because firing rates of SUM neurons were decreased in the stem, spike phases of SUM neurons to the CA1 theta were compared between stem and non-stem parts of the maze. It turned out that SUM cells delayed their preferred spiking time to a later phase of the theta rhythm when rats were in the stem, suggesting that SUM neurons may temporarily coordinate activity in the mPFC-Re-CA1 circuit during trajectory decisions. Optogenetic inhibition of the SUM resulted in reduced theta coherence on the stem. In the mPFC, the SUM photoinhibition did not change the proportion of cells showing trajectory-dependent firing. In the Re and CA1, however, this proportion was decreased, and there was also a decrease in firing rate between trajectories. The activity profile of the mPFC, Re and CA1 cells on the stem predicted the trajectory rats would choose. This was not the case for SUM neurons. When SUM neurons were inhibited, the predictivity potential was unchanged for mPFC neurons, but it decreased for Re and CA1 neurons. SUM inactivation did not alter behavioral performance. Because SUM inactivation did not alter firing rates in mPFC or Re neurons, it was hypothesized that the theta rhythm coordination was affecting the efficiency of information transfer between regions. Ito et al. found that SUM activation, which did not change the directionality of signal transfer between mPFC spikes and CA1 theta, inverted it between Re nucleus spikes and CA1 theta. They concluded that the coordination between theta frequency and spike time is gating information flow in the mPFC-Re-CA1 circuit. This coordination is modulated by SUM activity, on which the Re-relayed transfer of action plans by the mPFC to CA1 is depending.

3.3.2. Convergence of Re and entorhinal cortex afferents on CA1 dendrites

The Re nucleus and entorhinal cortex (EC) projections to CA1 converge in SLM, raising an interest for the study of a possible cooperation/interaction between the Re-CA1 and EC-CA1 pathways on pyramidal cell dendrites. In halothane- anesthetized rats maintained under artificial ventilation, Dolleman-van der Weel et al. (2017) implanted a 3-wire electrode array in the Re, and another one in the lateral EC (targeting layer III). The recording electrode, a multi-wire array, was placed in CA1, the tips being arranged along a depth line with a 30° mediolateral angle. From previous work, it was known that the responses in CA1 to Re or EC stimulations achieve a larger amplitude when the stimulations are delivered at low (0.1– 2 Hz in the Re; < 1 Hz in the EC) as

compared to e.g., theta (4– 10 Hz) frequencies (Dolleman-van der Weel et al., 1997; Schall et al., 2008). The low frequency, subthreshold stimulations were applied alternatively (Re-EC, Re-EC-Re-EC sequences, or occasionally in a sequence starting with EC) or simultaneously. In most instances, the stimulation consisted of paired pulses. The local field potentials elicited by the successive Re or EC (layers II/III) stimulations were negative going in SLM, but their slope was positive in *stratum radiatum* and *stratum pyramidale*. Given the profile of the field potentials and their latency, the polysynaptic determination of the events recorded in CA1 could be excluded to the advantage of a monosynaptic generation. Paired-pulse facilitation was observed with Re-only stimulations or EC-only stimulations. There was no evidence for heterosynaptic facilitation following successive applications of conditioning and test stimulations, be it in the Re-EC or EC-Re sequence. However, when paired pulses were applied simultaneously to Re and EC, the second field potential recorded in SLM was enlarged substantially in comparison with the first one.

These findings indicate that Re and EC projections to CA1 converge on dendrites of pyramidal neurons in the SLM, where, under the condition of at least two successive, low-frequency, and coincident inputs, they contribute to enhance excitation. While the functional incidence of such enhancement remains speculative, Dolleman-van der Weel et al. (2017) suggest that it could (lead to) improve synaptic plasticity and, in turn, facilitate consolidation of memories. This proposal is in line with an earlier proposal by Xu and Südhof (2013), who suggested that a cooperative activation of Re-CA1 and EC-CA1 synapses could reduce the threshold for triggering plasticity-related events at a synaptic level.

Regarding the report by Dolleman-van der Weel et al., this cooperation would meet optimal conditions when both pathways are activated concomitantly at a low (< 1 Hz) frequency. Interestingly, Jankowski et al. (2014, 2015) showed that about 64 % of the cells that they recorded in the Re of awake rats striding across an open field showed no spatial properties; among these, 53 had a firing frequency less than 1 Hz.

In urethane- anesthetized mice, Vu et al. (2020) used multichannel electrodes to record the response of CA1 to an electrical stimulation of the Re or of the medial perforant path (MPP), which encompasses axons arising from medial entorhinal cortex (MEC). The hippocampal signals (field potentials) were collected over a span ranging from *stratum pyramidale* to SLM, and sometimes even down to the dentate gyrus (DG). These signals were analyzed by current source density analyses. When stimulating the Re, the authors found a current sink in SLM and an almost concomitant current source in *stratum radiatum*, as previously reported by Dolleman-van der Weel et al. (1997) in rats; in both layers the latency was of about 9 ms, compatible with a monosynaptic activation of SLM by Re terminals. The sink (SLM) was followed by a source, and occasionally by sink-source oscillations in the gamma range (interval = 20– 40 ms), and the source (*stratum radiatum*) by a sink, compatible with late inhibitory influence on SLM. When paired-pulse stimulations (in the 20– 200 ms interval range) were applied to the Re, a paired-pulse facilitation was detected in CA1. Stimulation of the MPP also elicited a sink in SLM and a source in *stratum radiatum*, with an average latency of about 5 ms, again compatible with a monosynaptic effect. At most 100 ms later, these modifications were followed by an inverse pattern (i.e., source in SLM and sink in *stratum radiatum*). Conversely to the Re-to-CA1 projection, paired-pulse stimulation of the MPP induced paired-pulse depression.

Vu et al. also applied theta bursts to the Re in order to induce LTP of the Re-to-CA1 synapses. LTP was observed in about half the mice. This LTP was lasting for at least 2 h post-burst, be it of the sink in SLM or source in *stratum radiatum*. Furthermore, this LTP did not affect the excitability of the MPP-to-CA1 synapses. In part of the mice with DG recordings, a region to which the Re does not project (conversely to the MEC, which does), there was evidence for LTP after theta burst to the Re. This LTP was most probably at least disynaptic (Re activates the EC, which in turn activates granule cells in the DG). Theta burst stimulation of the MPP induced LTP in CA1, but also heterosynaptically potentiated the Re-to-CA1 synapses. Such potentiation, however, was not observed in all mice, as some of them showed long term depression (LTD, not

observed in Re-to-CA1 synapses after Re stimulation) of the SLM sink. Interestingly, in these mice, LTP of the Re-to-CA1 synapses was also observed. The difference between the LTP and LTD outcome of the MPP stimulation could be due to subtle variations in electrode placement, the mice showing LTP having the electrode placed more medially in the angular bundle than those showing LTD. These data indicate that the Re and the MEC may modulate activity on the proximal and distal apical portion of pyramidal cell dendrites in CA1. In some way, Re and EC terminals may even 'cooperate'. Indeed, the heterosynaptic potentiation elicited by MPP stimulations indicates that the excitability of the Re-to-CA1 synapse can be influenced by the inputs from the EC, an influence that could have implications in memory function, perhaps especially during information encoding, and which echoes the recent findings by Dolleman-van der Weel et al. (2017).

3.3.3. Re lesions affect the spatial stability of place fields in hippocampal CA1 place cells

Cholvin et al. (2018) performed permanent excitotoxic lesions of the ReRh nuclei. Place cells were recorded in CA1 of the dorsal HIP while rats performed a pellet-chasing session in a familiar vs. two unfamiliar cued arenas. Four daily recording sessions were enchainned. Unfamiliar and familiar arenas were alternated between sessions. Complex-spike pyramidal neurons with spatial selectivity and stable within-session activity were analyzed. On the first recording day, ReRh lesions had no impact on spatial characteristics (spike amplitude, height, frequency, spatial coherence, field size...) of place cells in the familiar environment, and the distribution of place fields was not altered. Furthermore, remapping (i.e., forming a specific configuration of place fields for two different arenas; here familiar vs. unfamiliar) was not affected by ReRh lesions. When recording was prolonged across 5 days, lesion-induced over-time alterations in spatial coherence and place field stability were detected in all arenas. These effects clearly indicate that the ReRh nuclei have an 'on-line' role in the representation of distinct environments in HIP cellular networks. The expression 'on-line' refers to a process requested while a mental operation is going on. After a ReRh lesion, the spatial representation of a simple environment appears less stable, therefore prone to forgetting or more sensitive to interference.

In adult mice, Jung et al. (2019) recorded the activity of CA1 pyramidal neurons (single-unit recording) after electrolytic ReRh lesions. They analyzed place cell properties in mice exploring a cued cylinder. Distal cues on a curtain surrounded the field. Between the first (0– 20 min) and the second recording session (20– 40 min), the cylinder was rotated 90° counterclockwise. Before the third session (40– 60 min), it was rotated 90° clockwise. In sham-operated rats, place cells had a mean firing rate, a mean in-field firing rate and a place field size that increased in response to cylinder rotation (first counterclockwise and then clockwise). These modifications were not observed in rats with ReRh lesions, suggesting a role for the ReRh in detecting or/and integrating ongoing detail changes in the environment.

3.3.4. Re contains place cells, head direction cells, and boundary cells, and contributes to goal-directed spatial navigation

Jankowski et al. (2014) recorded Re neurons in rats performing a pellet-chasing task in a cued arena. About 9% of the recorded cells (n = 483 from the Re) showed properties of head direction cells, which appeared quickly, were not affected by turning off the light or changing the arena shape (circular to square), and were stable across days. Such characteristics are those of classical head direction cells, which play a role in an animal's sense of direction (Taube, 2007). The anatomical pathways implicated in directional firing in the Re are not known for now, but one can notice that the Re has connections with other areas encompassing head direction cells. One year later, Jankowski et al. (2015) reported on the activity of neurons from the Re, the paratenial (PT) and the anteromedial nuclei (AM) in the rostral thalamus. In the Re, they found place cells (2.0%), head direction cells (8.7 %, reported in Jankowski et al.,

2014), and boundary cells (2.0%). Conversely to place cells in the AM and PT, which had small and sharp place fields, but could have two or three of them, place cells in the Re had single but less precisely-defined place fields. These place cells, head direction cells and boundary cells all showed intra-session stability of activity.

The authors did not report on the effects of functional alterations of e.g., the mPFC or the HIP on place or head-direction activity in the Re. Such alterations would be useful to the understanding of how and where these activities typically related to spatial navigation originate. The authors raised several hypotheses: **i)** information necessary for place activity in the Re is provided by the HIP, or goes the other way around, **ii)** the HIP and these thalamic nuclei work in parallel, **iii)** the two systems (thalamic and hippocampal) are bound by reciprocal, inter-dependent functional relationships. From the data in the literature it is not possible to privilege one or the other of these possibilities. It can be argued, however, that the HIP remains central because hippocampal damage disrupts spatial memory, and thus both navigation in previously explored environments and efficient recall of a previously constructed cognitive map. This is not the case with lesions or reversible inactivation of the ReRh nuclei, after which rats still learn a spatial task and retain it for some days (Cholvin et al., 2013; Klein et al., 2019; Loureiro et al., 2012).

Ito et al. (2015) documented an implication of the Re in the representation of goal-directed trajectories. How an animal uses place cells to go from one position to a goal position is unknown. Cell activity was recorded while rats performing a T-maze alternation task. About half the place cells (55.1%) of CA1 having a place field in the central stem of the maze showed firing rates depending on whether rats turned to the left or to the right. This was rarely observed in CA3, where the Re has no terminals. Of 64 neurons recorded in the Re, 27 (42%) showed a firing rate relying on the trajectory. In the mPFC, about one-third of the cells had firing rates depending on the trajectory. Re lesions decreased the proportion of place cells with a trajectory-dependent firing pattern (15.9 %) in CA1. Optogenetic inactivation of the Re had comparable effects. From this study, Ito et al. concluded that CA1, Re and mPFC form part of a neural circuit implicated in the representation of goal-directed trajectories. The mPFC and the Re are presented as sources for information about the movement a rat intends to make.

Given the data reported by Jankowski et al. (2015) on place cells in the Re (see above), it may seem surprising that, in the Re, Ito et al. (2015) did not find neurons with typical place cell activity. In fact, Jankowski et al. (2015) found a very small proportion of Re neurons (2.0%) to exhibit place cell properties. Ito et al. (2015) might have had a similar chance to detect a place cell in the Re and could have recorded too few neurons (49) to catch such a cell.

3.3.5. Re relays cortical control of vSub, which modulates activity of dopaminergic neurons in the VTA

The activity of dopaminergic neurons in the ventral tegmental area (VTA) is controlled by neurons of the ventral subiculum (vSub) via the nucleus accumbens (NAc) and the ventral pallidum (VP). The ILC controls the activity of the vSub. When it is inactivated, the dopaminergic activity in the VTA increases. This inhibitory control cannot be direct (monosynaptic) as there are no direct projections from the ILC to the vSub (e.g., Vertes, 2004). Hence, this control must be relay-mediated and involve at least one synapse. Zimmerman and Grace (2016) elegantly demonstrated that the Re nucleus could be this relay. First, in anesthetized male Sprague-Dawley rats, they reported an increase of activity in the VTA in response to the intra-Re infusion of the glutamatergic agonist NMDA (0.75 μ g in 0.2 μ L). This effect disappeared after intra-vSub infusion of tetrodotoxin (TTX; about 320 μ g in 0.2 μ L). Second, a systemic injection of d-amphetamine (0.75 mg/kg) induced hyperlocomotion in an open field, which was transiently (for about 20 min) potentiated by concomitant intra-Re infusion of NMDA. While intra-Re infusion of TTX had no effect on activity in the VTA, a TTX infusion into the ILC (about 320 μ g in 0.5

μ L) increased this activity, as previously shown (Patton et al., 2013). This modification was abolished by infusion of TTX in the Re. These findings place the Re in a hub position whereby the ILC exerts a modulatory influence on the vSub, which in turn controls dopaminergic activity in the VTA via the NAc and the VP.

To stay on the dopaminergic line, Tomasella et al. (2020) used positron emission tomography (PET) to measure glucose metabolism and presynaptic dopaminergic functioning in mice having no D2 receptors in parvalbumin-positive interneurons. These mice show schizophrenia-like alterations at behavioral, cellular and molecular levels (Tomasella et al., 2018). Under baseline conditions, the difference between control and mutant mice was relatively weak: mutants showed an increased metabolism in the amygdala. Under an amphetamine challenge boosting the dopaminergic system, however, mutants showed weaker metabolism (compared to amphetamine-treated controls) in the PFC, the amygdala, but also the Re nucleus. The implication of the Re nucleus is in line with its potential contribution to schizophrenic symptoms (see Dolleman-van der Weel and Witter, 2020 current issue).

4. Implications of ReRh nuclei in behavior

Older studies gathered evidence showing an implication of ReRh nuclei in physiological regulations such as **i)** circadian physiology and reproduction, **ii)** feeding behavior, including when under the control of photoperiod length, **iii)** nociception (for which arguments were essentially correlative, based on early gene imaging), and **iv)** arousal, stress and anxiety (e.g., Cassel et al., 2013). Most of the literature, however, provided experimental arguments implicating the ReRh nuclei in cognitive processes. These encompassed **i)** inhibitory control processes, especially impulse inhibition and motivational control, but most likely not attention *per se*, **ii)** avoidance memory, which relates to inhibitory mechanisms, as animals must refrain from returning to a particular place by remembering having had an aversive experience there, **iii)** information encoding, **iv)** working memory, and perhaps more specifically spatial working memory, **v)** recent spatial reference memory in the water maze, although the ReRh nuclei might contribute more to organization of goal-directed behaviors in a spatial context than to recent spatial memory *per se*, **vi)** strategy shifting and behavioral flexibility, and **vii)** systems-level consolidation, a process constructing persistent memories (e.g., Cassel et al., 2013). Recent articles brought arguments in favor of a role for the ReRh in generalization of fear memories, in (spatial) working memory, and in systems-level consolidation. Their implication in attention appears more questionable, available data being contradictory. Recent work also highlighted a possible implication of ReRh in processes not yet studied, such as information encoding and memory reconsolidation or extinction.

4.1. Information encoding

Encoding refers to a process by which the information collected by the nervous system is transformed in a representation that can be kept for some time in a short-term memory buffer or stored for much longer in long-term memory (e.g., Cohen et al., 2015). The possible implication of the ReRh nuclei in information encoding is an important question, not only because encoding is the starting point of memory formation and much of the memory content and persistence depend on what is encoded (see section 4.2.), but also because part of the studies having investigated the implications of the ReRh nuclei in memory functions have used or still use permanent lesions. And it turns out that a permanent lesion could interfere with encoding, consolidation and recall of information, since it is present at all steps of the memory process.

Ramanathan et al. (2018a) reported on contextual fear conditioning. Before acquisition and/or retrieval, the Re was inactivated (muscimol). During conditioning, the rats with inactivated Re froze slightly more than controls. When tested after 24 h or 48 h without muscimol, freezing was low, indicating altered information encoding or immediate post-encoding alteration of consolidation. However, when tested under muscimol, the rats showed high

freezing levels. When the Re was active during acquisition, pre-retrieval muscimol infusion had no effect. When rats were retested in a novel context the next day, freezing was still increased in those given muscimol before both conditioning and retrieval testing; it was increased to a weaker extent in those trained without muscimol but subsequently tested in the conditioning context under muscimol inactivation. In both other groups (controls [no muscimol]; muscimol before conditioning only), freezing was low.

This set of results shows that Re inactivation does not hinder retrieval of a contextual fear acquired drug-free, confirming conclusions of other studies on fear memory (e.g., [Quet et al., 2020a](#)) or recent spatial memory ([Cholvin et al., 2013](#); [Loureiro et al., 2012](#)). The data also show that rats inactivated before encoding and before retrieval express the fear in a state-dependent manner, in a manner suggesting that the muscimol effect has been encoded as part of the context. A similar observation was made in rats trained in a trace conditioning protocol: when trained under muscimol-inactivated ReRh, rats did not remember the association in a drug-free retrieval session, but they remembered it when tested under ReRh muscimol inactivation ([Lin et al., 2020](#)).

The experiments by [Ramanathan et al. \(2018a\)](#) assessing fear retrieval in a second context indicate that inactivation of the Re resulted in the encoding of a less detailed contextual memory. In an additional experiment using intrahippocampal infusions of the NMDA receptor antagonist aminophosphonovalerate (APV) combined to Re inactivation during conditioning, the authors could demonstrate that contextual fear was most probably not encoded in a network encompassing the HIP. Taken together, these results might not provide very strong arguments in favor of a role for the Re in the encoding of an external context. It is possible that under Re inactivation, the association between unpleasant electrical shocks does not establish only with external elements of the context, but also with internal ones constituted by the (neuro)physiological consequences of the Re inactivation. Alternatively, it is also possible that, under Re inactivation, the context with which the association is established consists in a fusion of external and internal contextual elements, hence the state-dependency.

[Maïsson et al. \(2018\)](#) used a delayed non-match-to-position (DNMP) task in a T-maze taxing spatial working memory to explore a possible contribution of the Re to information encoding. Rats were tested under the condition of an optogenetic inactivation of the Re. The inactivation lasted for either the entire session (sampling trial + delay + test trial), only the sampling, only the delay, or only the test trial. It was found that neither the delay nor the test trial inactivation affected choice accuracy. Conversely, both the entire session and the sampling inactivation impaired choice accuracy, showing clearly that when activity in the Re is reduced, the spatial working memory system does not properly encode task-relevant information.

[Barker and Warburton \(2018\)](#) used a variety of object recognition tasks in rats to assess the behavioral consequences of permanent lesions, reversible inactivations, cholinergic or glutamatergic receptor blockade, and protein synthesis inhibition of the Re. The recognition tasks assessed capacities for **i**) recognition of object and its location (i.e., object-in-place associative recognition memory), which requires the mPFC, the HIP and the perirhinal cortex (PRC), and especially information exchange between the mPFC and HIP, **ii**) object recognition only, which requires the PRC, and **iii**) object location only, which requires the HIP. A permanent Re lesion had no effect on object recognition or location tasks. The lesion altered object-in-place associative recognition memories after a 3 h delay (not after 5 min). Muscimol infusions into the Re before the encoding stage disrupted performance after a 3 h- not a 5 min delay. Retrieval after the long delay was also disrupted by muscimol in the Re. Information encoding did not depend on NMDA receptor-mediated mechanisms, but required muscarinic and nicotinic receptor-mediated ones. Furthermore, the formation of an associative recognition memory lasting for 24 h depended on protein synthesis in the Re. Taken together, the results indicate that the Re is required for encoding (but also retrieval) of long-term associative recognition memory requiring interactions between mPFC and HIP. That pretraining inactivation of the Re altered retrieval at 3 h and not at 5 min

suggests that the deficit was less due to encoding failures than to an incapacity to hold the encoded information for as long as 3 h.

[Jung et al. \(2019\)](#) also assessed object location recognition, but in mice. Effects of electrolytic ReRh lesions were assessed in an open field, a Y-maze alternation task assessing working memory, and an object location task. A deficit was found on object location. This deficit, however, became evident only during the second half of the test duration: during the first 2.5 min, sham-operated and ReRh mice had a much larger exploration time on the displaced object than on the in-place one. During the next 2.5 min, this preference was still observed in sham-operated mice, no longer in mice with ReRh lesions. This observation is at variance with the data reported by [Barker and Warburton \(2018\)](#), who found no effect of excitotoxic ReRh lesions. Therefore, an alternative interpretation of the data reported by [Jung et al. \(2019\)](#) could be that mice lost their motivation or interest for the displaced object faster than their sham-operated counterparts, as described in rats with ReRh lesion or inactivation when searching for a platform in the probe trial of a water maze task ([Cholvin et al., 2013](#); [Dolleman-van der Weel et al., 2009](#)): focused searching is given up earlier than in the control animals.

4.2. Generalization of fear memory

Generalization of a memory is an adaptive process by which a memory trace undergoes modifications leading an animal to respond to contextual items which resemble but are not identical to those of the initially stored information (e.g., [Asok et al., 2019](#); see also [Fig. 7 A and B](#)). First evidence for a role of the Re in generalization of contextual fear was reported by [Xu and Südhof \(2013\)](#). Xu and Südhof showed that when conditioning is performed following overexpression of tetanus toxin in mPFC-projecting Re neurons, what reduced ACC and CA1 excitability, mice rapidly overgeneralized contextual fear. After an experimental manipulation (local neuroligin-2 knockdown) reducing GABA-mediated inhibition of Re neurons (e.g., [Jedlicka et al., 2011](#)) the opposite result was observed. Xu and Südhof also used optogenetic tools to check if during conditioning the activation pattern of Re neurons modulated the level of detail with which the context is encoded. Re neurons expressing channel rhodopsin were activated by tonic (4 Hz stimulus trains) or phasic (15-pulse stimulus bursts) light stimulation during conditioning. Mice acquired fear normally and froze comparably when exposed to the conditioning context. However, the phasic stimulation produced increased fear towards the degraded context, and the tonic stimulation resulted in decreased freezing. Together these findings demonstrate a role of the Re in controlling the precision with which information is encoded or processed during/right after conditioning.

This is also one of the conclusions of an article by [Troyner et al. \(2018\)](#), who showed in rats that muscimol-induced inactivation of the Re right after contextual fear conditioning did not hinder freezing to context one day after conditioning. On the next day in a different context, however, inactivated rats showed a freezing response outpassing that of controls, due to generalization. When remote memory was tested (post-conditioning delay of 21 days), exacerbated freezing was found in inactivated rats both in the paired and in an unpaired context. The same was observed with a weaker conditioning protocol (1 electrical shock instead of 3), indicating that it does not seem to depend on memory robustness. Using the 3-shock protocol, [Troyner et al. \(2018\)](#) also showed that post-conditioning inactivation of the Re attenuated subsequent extinction of the freezing response in the conditioning context (see section 4.7). Thus, Re inactivation also contributed to the construction of a more robust memory (i.e., stronger with less details). Finally, rats were also trained in the 3-shock protocol and subjected to inactivation of the Re (90 min) before being killed for immunostaining of the plasticity-related Arc protein. In the absence of Re inactivation, fear conditioning did not change Arc expression in the Re, PLC and ACC, but increased it in the dorsal/ventral HIP and ILC. After Re inactivation, Arc expression was decreased in the Re, ILC, ventral HIP, and increased dramatically in the dorsal HIP.

Thus, post-conditioning inactivation of the Re increased generalized aversive memory robustness, to which decreased plasticity in the Re, ILC, and ventral HIP, as well as increased plasticity in the dorsal HIP during consolidation may have contributed by mechanisms that call for elucidation.

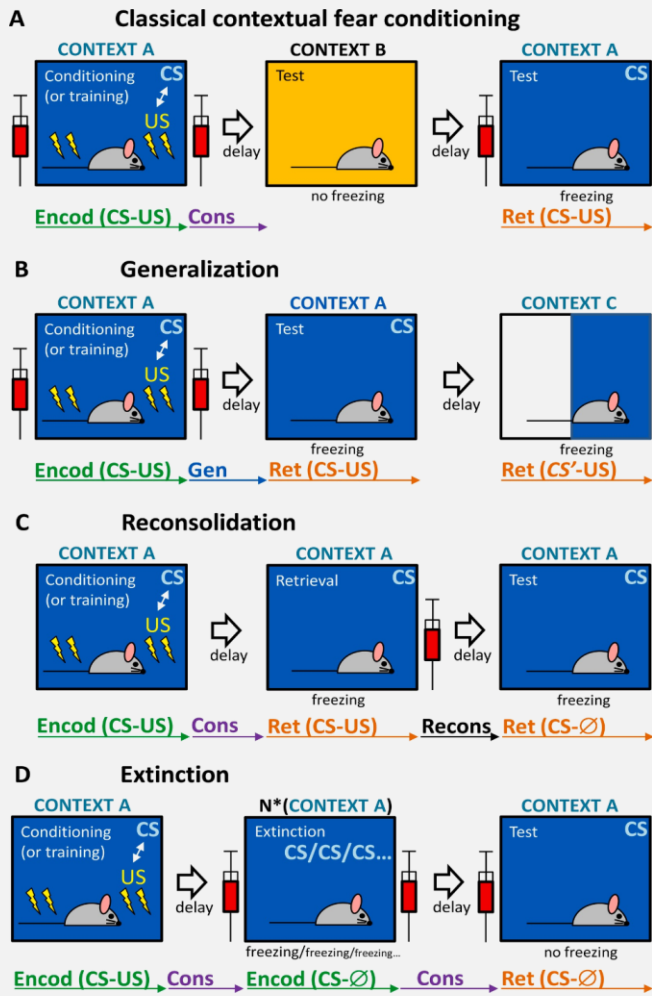

Fig. 7. Basic principles of the procedures used for establishing contextual fear conditioning (A) and subsequently testing fear generalization (B), fear reconsolidation (C) and fear extinction (D). (A) For conditioning, mice or rats are trained in a context with cues enabling its identification and discrimination from other differently-cued contexts. The principle of training consists in the administration of unpleasant electrical shocks (the unconditional stimulus, or US) some time after an animal has been introduced into the contextualized conditioning box (the conditional stimulus or CS, here context A). This way, an association between the US and the CS is established and encoded (**Encod(CS-US)**), making the CS predictive of the US. This information then undergoes consolidation (**Cons**). Therefore, when after some delay (which may vary from seconds to months), the animal is re-exposed to the CS, this exposure triggers fear, which the animal expresses by remaining mainly immobile, a behavior called freezing (freezing). This immobility time reflects retrieval (**Ret(CS-US)**) of the CS meaning, indicating that the CS has been correctly encoded, correctly memorized by the way of consolidation, and correctly recalled. When the delay is of one to a few days, the memory retrieved is termed recent memory. When it is in the range of about one to a few weeks or even more, the memory retrieved is termed remote memory. If the animal is placed in a different context (context B), there is no fear (except in case of memory generalization; see e.g. [Xu and Südhof, 2013](#)), only occasional immobility that does not relate to fear is shown, and thus only a very short cumulative freezing time corresponding to baseline immobility (no freezing) is recorded. Using this procedure, it is possible to investigate the effects of various compounds (e.g., receptor agonists or antagonists, protein synthesis inhibitors, sodium channels blockers...), pharmacogenetic or optogenetic manipulations (seringe in red) on encoding, consolidation or retrieval by their administration before/during CS encoding, during the early or late consolidation process of the CS meaning, or before testing retrieval capabilities. (B) To test memory generalization (**Gen**), the conditioning is established as in (A) or (B). Subsequently, when the animal is re-exposed to the same CS, the corresponding associative memory is activated (**Ret(CS-US)**) and the animal exhibits the typical fear-related behavior, namely freezing. Once the generalization process has occurred, the animal is exposed to a degraded CS, i.e., a context contains items specific of the conditioning context and items that have nothing to do with the latter. As the generalization process leads to a less precise memory, the animal reacts to the degraded context as it did when it was exposed to the conditioning one (**Ret(CS'-US)**). (C) To test reconsolidation, the conditioning is established as in (A) or (B). Subsequently, the animal is re-exposed to the CS (i.e., same context) in the absence of the US and the animal activates the corresponding memory (**Ret(CS-US)**). Experimental manipulations can be made right after this re-exposure (seringe in red), which has triggered a period of memory lability followed by a reconsolidation (**Recons**) process leading to a restabilization of the memory that the retrieval had fragilized. When this reconsolidation process is disrupted by drugs or other tools (seringe in red), the animal shows no freezing when subsequently tested in the same context (**Ret(CS-Øt)**). (D) To test extinction, once the conditioning has been established (exactly as in (A): **Encod(CS-US)** and **Cons**), the animal is re-exposed repeatedly to the CS (**Encod(CS-Ø)**), always in the absence of the US. This leads to the progressive encoding and consolidation of extinction (making the CS no longer predictive of an unpleasant experience) leading the animal to show low levels of freezing (no freezing) when subsequently re-tested for extinction retrieval (**Ret(CS-Ø)**) in the same context. Using this procedure, experimental manipulations with drugs or other tools (seringe in red) can target the encoding, consolidation or retrieval of the extinction. This figure has been inspired by Fig. 1 provided in the review article by [Kwapis and Wood \(2014\)](#).

4.3. Attention

All explicit information contained in a given environment is potentially perceptible by the nervous system. Attention is a cognitive function enabling a selective concentration of the brain on a specific part of the whole, while the rest does not undergo conscious perception (e.g., [Fizet et al., 2016](#); [Muir, 1996](#)). The first paper to associate the Re nucleus with attention was by [Linley et al. \(2016\)](#). These authors explored attentional set formation and set shifting, behavioral flexibility, and reversal learning. Rats subjected to electrolytic lesions of the ReRh were trained and tested in a food-rewarded attentional set shifting task.

In this task, they had to dig in an appropriate ramekin – two were presented at one end of a rectangular arena – filled with odor or unscented digging medium. In one of these ramekins a food reward was dissimulated. Over successive trials, the location of the reward was indicated by a paired odor (simple discrimination task), a different odor being present on the second ramekin, but the medium was the same for both. In the compound discrimination task, the odor, which was associated to different mediums, still indicated the reward: rats had to respond to the odor regardless of the medium to which it was associated. In the reversal task, the other odor became predictive of the reward location. The intradimensional shift task

relied on the introduction of two novel odor/digging medium pairs; rats had to use the previously learned rule: attend the correct odor. For the reversal tasks, the other odor predicted the reward location. The extradimensional shift task, which assessed attentional set shifting, introduced an additional pair of odor/digging mediums, but now the task consisted of ignoring odors, the digging medium being the predictor of reward location. For reversal, the other medium predicted the reward location.

In comparison with sham-operated controls, rats with ReRh lesions had no problem discriminating two odors or two digging mediums. Rats with ReRh lesions, however, were impaired in both attentional set shifting and behavioral flexibility: their performance was altered on the first reversal of the compound discrimination task and on the latter's intradimensional shift stage. These

observations suggest a role for the ReRh in some executive functions and thus, in functions that depend on the mPFC.

In a former study, [Prasad et al. \(2013\)](#) found excitotoxic (NMDA) lesions of the Re to reduce compulsive behavior in a sustained visual attention task (5-choice serial reaction time task). As compulsive behavior is exaggerated after prefrontal lesions, this finding may appear intriguing. To pursue this line, [Prasad et al. \(2017\)](#) tested rats with excitotoxic (NMDA) Re lesions in a battery of tasks taxing combined attention-memory (CAM), spatial memory, visual discrimination and reversal learning, and decision making with delayed outcomes.

In the CAM task, rats had to respond (nose poke) to the detection of a visual stimulus presented in a given location, a response for which they were reinforced when correct. After various delays, two visual stimuli were presented simultaneously (one in the former location, the other in a different location) and rats had to respond to the stimulus shown in the new location. Rats with Re lesions performed better (choice accuracy larger and premature responses lower) than their sham-operated counterparts when the stimulus duration was of 0.7 s. With longer durations, there was no lesion effect.

In the spatial memory task, rats had to visit 4 out of 8 baited arms and, after a delay of 0, 10 or 30 min, to visit the remaining ones. Rats with Re lesions were impaired when the four remaining arms became accessible with no delay, but they behaved like controls for delays of 10 or 30 min (it is noteworthy that control performance worsened in comparison with the 0 delay).

On the visual discrimination task, most probably reflecting enhanced attention, rats with lesions performed better than controls: they required fewer sessions to reach criterion. In the reversal task, they were like controls. However, with a new reversal, they were again better. Finally, in the decision making task, rats had to choose among a pair of visual stimuli, either the one giving access to an immediate but small reward or the one giving access to a delayed (by 8, 16 or 32 s) but larger reward. There was no difference between the rats with lesions and controls. These data illustrate a Re lesion-induced increase in performance in a task assessing executive functions, among which attention. Although the lesions and tasks were different, the outcome of both studies performed by [Prasad et al. \(2013, 2017\)](#) is at variance with the outcome of the study of [Linley et al. \(2016\)](#), calling for further investigation of a possible role of the ReRh in attention.

4.4. Spatial working memory

Working memory is a cognitive system that holds a limited amount of information for a short period of time, usually as long as this information is useful in an ongoing mental operation (e.g., [Baddeley, 1986](#); [d'Esposito and Postle, 2015](#); [Dudchenko, 2004](#)). A review by [Griffin \(2015\)](#) dealt with the implication of the Re in working memory (see also current issue). Since then, a few articles have consolidated the link between Re and working memory. [Layfield et al. \(2015\)](#) designed a study with the idea that mPFC and HIP interact in working memory tasks. This interaction, however, could be less crucial when information is maintained over a short delay as compared to a longer one (e.g., [Churchwell and Kesner, 2011](#)). To test this hypothesis, the effects of muscimol-induced ReRh inactivation were investigated on spatial working memory in a continuous (no delay) vs. a delayed alternation task (delays of 5 or 30 s) in a T-maze (the same as in [Hallock et al., 2016](#)). [Layfield et al. \(2015\)](#) found that the highest amount of muscimol altered performance, whatever the delay, thereby raising questions about anatomical selectivity of the effect. Interestingly, a lower and more selective amount of muscimol impaired performance at the 5 s delay, although the intermediate amount did not affect performance at this delay. The authors concluded that the ReRh nuclei contributed to a spatial working memory task requiring to hold information for some time. This conclusion was confirmed in the study by [Hallock et al. \(2016\)](#) at a delay of 30 s (see above, section 3.3.1).

[Viena et al. \(2018\)](#) also used a delayed non-matching task in a T-maze. Delays were of 0, 30, 60 or 120 s. Three types of errors were distinguished:

working memory ones (no alternation after an arm choice), win-shift errors (no alternation after a correct choice), and perseverative errors (re-entries in incorrect arm). Once rats had reached an 80 % choice accuracy, they were tested after intra-Re infusion of muscimol or procaine. Muscimol reduced the number of correct alternation trials, confirming a Re contribution to spatial working memory. As discussed above (see section 4.1.), at least part of this deficit might be attributed to encoding failures ([Maïsson et al., 2018](#)). Muscimol also delay- and dose-independently increased the number of win-shift and perseverative errors, indicating that rats had trouble adapting their behavior to negative feedback, as shown by [Cholvin et al. \(2013\)](#) in a spatial memory task. Procaine produced only limited effects.

That the Re is implicated in spatial working memory is also the conclusion of the study by [Duan et al. \(2015\)](#) in rats. These authors optogenetically stimulated the Re nucleus in the delta frequency band during a food-rewarded working memory task. Before optogenetic stimulation of the Re, which affects the region CA1 in addition to other projection targets (see [Fig. 2](#)), rats had been trained to an about 90 % correct alternation performance. The optogenetic stimulation of Re neurons induced a clear deficit in the working memory task. [Bobal and Savage \(2015\)](#) used a model of thiamine deficiency based on pyriothiamine administration. Rats with thiamine deficiency (PTD), which showed appropriate tissue loss, exhibited impaired spontaneous alternation in an elevated plus maze. Intracortical and intrahippocampal infusions of the cholinesterase inhibitor physostigmine, both given in combination ipsi- or bilaterally, restored alternation rates. Unilateral, single site infusions had no effect. When the Re was inactivated by muscimol infusion, there was an alternation deficit. In addition, the muscimol infusion into the Re abolished the beneficial effect of physostigmine in PTD rats. These data indicate a role for the Re in working memory depending on cortico-hippocampal functional interactions, including in the mediation of beneficial physostigmine effects in the cortex and HIP of PTD rats.

When taken together, all these recent data converge towards an implication of the Re in spatial working memory tasks requiring the mPFC and the HIP, and most probably information exchange between the two structures.

4.5. Systems-level consolidation

Systems-level consolidation, or systemic consolidation, is a process by which memories, initially stored in the HIP, are constructed in cortical modules to enable their persistence (e.g., [Frankland and Bontempi, 2005](#); [Squire et al., 2015](#)). The first paper to implicate the ReRh in systems-level consolidation was by [Loureiro et al. \(2012\)](#). Since then, further evidence for a role of the ReRh in this consolidation process, especially of spatial and fear memory ([Ali et al., 2017](#); [Klein et al., 2019](#); [Quet et al., 2020a](#)), but not of social transmission of food preference ([Quet et al., 2020b](#)), has accumulated. For more detail, see the review by [Ferraris et al., 2021](#) current issue).

4.6. Memory reconsolidation

Once an initially labile memory is consolidated, it is usually kept latent. The reconsolidation hypothesis posits that when it is retrieved, it becomes again labile, undergoing reconsolidation thereafter. During the second phase of lability, the memory is disruptable by amnesic agents (e.g., [Lee et al., 2017](#); see also [Fig. 7C](#)). Two recent papers implicate the Re in reconsolidation of a memory. The first, by [Sierra et al. \(2017\)](#), addressed the question of mPFC (ACC) activity in systems-level consolidation of a contextual fear memory in rats. When the ACC was inactivated by muscimol infusion before acquisition, both recent and remote memories were impaired. These observations are compatible with a role of early cortico-hippocampal communication in fear memory persistence (e.g., rev [Frankland and Bontempi, 2005](#); see also [Lesburguères et al., 2011](#)). Interestingly, when the memory was reactivated in the absence of shock 2 days after ACC-inactivated acquisition, remote memory appeared normal. In an additional experiment, [Sierra et al. \(2017\)](#) then demonstrated that the memory-rescue effect of memory reactivation was due

to a reconsolidation process. Indeed, systemic pre-reactivation administration of nimodipine, an antagonist of voltage-gated calcium channels interfering with reconsolidation mechanisms, disrupted the rescue effect. Recent memory, however, was not affected by nimodipine treatment. Then, a role of the ACC in the memory-reactivation effect of remote memory was demonstrated by intra-ACC lidocaine infusion before the reactivation session. After lidocaine, the reactivation-induced rescue of remote memory was disrupted; lidocaine had no effect on recent memory retrieval. Interestingly, lidocaine into the Re before the reactivation session had similar consequences on the rescue of remote memory by reactivation, as well as on the expression of a remote memory when acquisition was not altered by intra-ACC muscimol. Lidocaine in the Re had no effect on recent memory. A final experiment assessed the effects of high frequency stimulation of region CA1 of the HIP on long term potentiation (LTP) in the ACC with or without lidocaine-induced Re inactivation. Lidocaine reduced LTP in the CA1-mPFC pathways. This article by Sierra et al., for the first time, pointed to a role for the Re in memory reconsolidation processes, and confirmed that for systems-level consolidation, a cortical activity implicating the Re is crucial (see also Quet et al., 2020a; Ferraris et al., 2021).

The second paper (Troyner et al., 2018) includes several experiments testing the impact of muscimol inactivation of the Re on consolidation, generalization, extinction, and persistence of fear memory (see Sections 4.2 and 4.7). Troyner et al. also tested the effect of muscimol inactivation of the Re during fear memory consolidation (post-conditioning) on:

i) later memory destabilization (after memory reactivation by re-exposure to the context without US), and attenuation by clonidine-induced reconsolidation disruption (an alpha-2 receptor agonist, e.g. Gazarini et al., 2013, 2014), and ii) clonidine effects on reconsolidation, but in the absence of prior memory destabilization. They showed that a fear memory consolidated under Re inactivation is less prone to destabilization and to clonidine-induced reconsolidation disruption: clonidine had no significant effect on generalized fear expression, be it after memory reactivation or without memory reactivation. The authors proposed that Re inactivation during consolidation results in a less consistent fear memory, but which shows better resistance to destabilization, to context-dependent extinction (see section 4.7), and to updating by the way of reconsolidation.

4.7. Memory extinction

Extinction is a process by which previously acquired knowledge can be inhibited by a new learning. It is often studied in operant and classical conditioning. An animal acquires an association between a CS (e.g., a tone or a context; see Fig. 7A) and an US (e.g., an unpleasant electrical shock). When the animal is subsequently re-exposed once to the CS without the US, it displays the appropriate response (e.g., freezing). If the same scenario is then repeated several times, the response progressively disappears (e.g., Marek et al., 2019; see also Fig. 7D). A possible contribution of the Re nucleus to extinction of memories has been addressed using variants of fear conditioning. In section 4.2., we already mentioned the report by Troyner et al. (2018), who showed that post-conditioning inactivation by muscimol infusion into the Re not only enhanced generalization but also attenuated subsequent drug-free extinction of the freezing response towards the conditioning context. Following the extinction session, freezing was still higher in the inactivated rats as compared to their controls, be it in the paired or unpaired context. This attenuation of extinction might be a corollary of increased generalization. Indeed, in a recent article, Pedraza et al. (2019) separated a population of fear conditioned rats into 'generalizers' and 'discriminators', and found the former to be more resistant to extinction of the context than the latter.

Ramanathan et al. (2018b) used pavlovian fear conditioning associating a CS (tone) and US (electrical shocks) in rats. Fear was conditioned in a given context and, 1 day later, extinguished in a different context (CS, no US). Extinction retrieval was tested in this different context after another day, and, finally, renewal (i.e., a time-dependent reinstatement of an extinguished conditioned behavior) was assessed in the initial conditioning context.

Ramanathan et al. infused muscimol into the Re before rats experienced the extinction session. Under the Re inactivation, there was no evidence for extinction, suggesting an encoding default of the CS extinction. Furthermore, when the Re was inactivated before testing the retrieval of an extinguished tone, freezing was higher than in controls, indicating that the Re is also required for inhibiting a fear response to an extinguished CS. For renewal, control and Re-inactivated rats showed comparable freezing. Both encoding and retrieval (or renewal) of extinction resulted in increased c-Fos expression in the Re. Using a DREADD technology, the mPFC projections to the Re were silenced during extinction. Silenced rats froze more than controls. Freezing also increased when CNO was injected i.p. right before extinction retrieval in rats in which the CS had been extinguished during a drug-free session. Taken together, these findings show that the Re is necessary for the encoding and retrieval of extinction memories, most probably by playing a role as a target/relay of the top-down inhibitory control exerted by the mPFC.

Ramanathan and Maren (2019) also addressed the possibility of an implication of the Re in the extinction of a contextual fear memory in rats. Conditioning was performed drug-free. After a 1-day rest, muscimol was infused into the Re 10 min before a retrieval/extinction session, and, after another 1-day delay, again before another exposure to the context. One day after conditioning, rats subjected to intra-Re infusion of saline showed freezing, indicating a recall of the context. Over time (i.e., 35 min), freezing decreased substantially due to extinction. The rats given intra-Re muscimol also froze to the context but did not extinguish. After another day, those having received saline the day before, and which were retested after saline treatment, had extinguished. Those having received muscimol before this second test had a higher level of freezing, a level even tending to increase over time. Among the rats that received muscimol before the extinction session, those retested after saline treatment froze at the start, but freezing decreased thereafter, unlike in rats retested under muscimol. Taken together, these data indicate that the Re is mandatory to extinction of a conditioned contextual fear, a process known to depend on a tripartite cooperation implicating the amygdala, the HIP and the PFC (e.g., Marek et al., 2019; Moscarello and Maren, 2018; Qi et al., 2018).

Silva et al. (2018) used contextual fear conditioning to assess memory retrieval and extinction. They constructed a brain activation map corresponding to the recall of a remote memory (35 days post-acquisition) to compare it with the activation map resulting from exposure to a context after extinction. When mice retrieved the remote memory, evidence for an increase (vs. context-exposed mice without electrical shocks) in the density of c-Fos expressing neurons was found in the ACC, the PLC and the retrosplenial cortex, in the central and basolateral nuclei of the amygdala, in regions CA1 and CA3 of the ventral (not dorsal) HIP, and in the ReRh nuclei. All of these structures but one (the central nucleus of the amygdala) exhibited a comparable increase of c-Fos expression after the remote memory had been extinguished. A network connectivity analysis showed a high correlation between the ReRh and the cortical, hippocampal and amygdalar regions in both 'recall-only' and 'recall + extinction' groups. One functional connection between the ventral HIP and cortical areas was specific to extinction of remote memory. These observations generate two possible interpretations of the high similarity of activation patterns accompanying remote memory recall and extinction. First, a new memory trace of safety is associated to the existing cortical trace which persists in the structures supporting the remote memory. Second, the initial remote memory trace undergoes an extinction-triggered updating during which, by the way of a reconsolidation process, it progressively integrates safety, and therefore needs to remain active, even at the fourth day of extinction training. Whatever the explanation for the observed similarity between recall and extinction brain activation pattern, the ReRh seems to be a crossroads between hippocampal, cortical and amygdalar processes implicated in the retrieval of a remote fear memory as well as its extinction.

4.8. Miscellaneous

This section is dealing with some articles we have not been able to easily classify in previous parts of the review.

4.8.1. Mediation between internal states and behavioral responses to perceived threats

In the study by [Salay et al. \(2018\)](#), mice were placed in a closed field where they could be exposed to a dark, rapidly expanding, threatening stimulus that mimicks a predator approaching from above. The mice responded to it by spending most of their time (>90 %) freezing and hiding under a shelter. In response to the perceived threat, c-Fos expression was more than doubled in the ReRh (VMT) and more than tripled in the xiphoid nucleus (Xi). DREADD-mediated inactivation of the VMT did not modify the response to the threatening stimulus. Activation, however, produced a shift towards saliency-reducing behaviors such as less freezing, increased tail rattling, more running outside the shelter.

Next, the authors showed the major projection of the Xi to synapse in the amygdala, whereas the major projection of the VMT synapsed in the mPFC. They activated (pharmacogenetically or optogenetically) each pathway separately. Activation of the VMT-amygdala pathway induced an increase of freezing without affecting tail rattling. The activation of the VMT-mPFC pathway had no effect on freezing but increased tail-rattling behavior. When optogenetic VMT stimulation was performed 30 s before the presentation of the threatening stimulus, the behavioral changes were identical to those resulting from concomitant VMT stimulation and threatening stimulus presentation. This result suggests that the VMT stimulation changes the internal state of the animal. Evidence that VMT stimulation increased arousal levels was confirmed by the fact that the stimulation induced pupil dilatation and heart rate acceleration. But was it emotionally a consequence of rewarding or aversing effects? In a real-time place preference test, the authors showed that the mice exhibited a preference for the compartment in which the VMT was optogenetically stimulated, in line with a rewarding incidence of the stimulation. Finally, Salay et al. established that when the mice were exposed to a threatening stimulus, the firing rate of 4 out of 5 recorded VMT neurons augmented. This response disappeared after habituation to the stimulus.

Altogether, these findings posit the VMT, therein the Re, as important in the determination of how internal states influence behavioral responses to perceived threats.

4.8.2. Memory for sequence of events

[Jayachandran et al. \(2019\)](#) trained a series of rats in a task taxing memory for sequences of events. Thirsty rats had to nose-poke in a port for more than 1 s in response to the presentation of a sequence of 4 different odors according to an A,B,C,D succession. This identical succession of odors appearing 70 % of the time was termed an InSeq item. If rats correctly nose-poked for more than 1 s, they were delivered a water reward. In 30 % of the trials, odors were not presented according to the A,B,C,D sequence. The modified sequence was termed an OutSeq item. In OutSeq items, the presentation of an odor could be repeated right after its first occurrence (e.g., A,A... or A,B,B...; termed a 1-back lag), or with a lag of 1 rank (e.g., A,B,A... or A,B,C,B; termed a 2-back lag), 2 ranks (e.g., A,B,C,A; termed a 3-back lag), or at the wrong place (e.g., A, C,C,D). When an odor was repeated, whatever the back lag, rats had to withdraw their nose from the port within less than 1 s to get the reward. In the first experiment, the mPFC was injected with an hM4Di-bearing viral vector. When rats were administered i.p. CNO before the task, their sequence memory performance dropped to chance level. In the next experiment, hM4Di was expressed in mPFC axons projecting to the Re or in those projecting to the perirhinal cortex (PRC). CNO was infused directly into the Re or PRC. Both manipulations dropped performance to chance level, indicating that projections from the mPFC to one or the other nucleus are crucial for normal

sequence memory. The authors then distinguished the type of errors made by the rats according to whether they could be attributed to a working memory failure or to temporal context memory failure. A working memory failure was considered when rats failed to detect a repeated odor at short lags (current odor compared to a most recently perceived one in a given sequence). A temporal context memory failure was considered when rats failed to detect a repeated odor at long lags (current odor analyzed according to the preceding sequence of odors).

This analysis yielded data indicating an implication of mPFC to Re projections in non-spatial working memory, extending data summarized in section 4.4, and on mPFC to PRC projections in temporal context memory.

4.8.3. Incidental contextual learning : Context pre-exposure facilitation effect (CPFE)

In this study, [Heroux et al. \(2019\)](#) studied the context preexposure facilitation effect (CPFE) in adolescent rats. This effect is produced by a testing procedure in which experimental subjects are first preexposed to a to-be-conditioned context without the US. Such preexposure enables the construction of a representation of the context, or contextual engram. Second, preexposed subjects are returned to this context and receive immediate foot-shock (US), a procedure which would not generate contextual fear by itself, but which actually does so as a result of preexposure to the context. Although this study used muscimol-induced reversible inactivation prior to context preexposure in order to tackle a possible contribution of the mPFC and ventral HIP (vHIP) to CPFE, immediate early gene (IEG) expression was also assessed after a 1-day delayed retention testing in the mPFC, vHIP, dHIP and VMT, including the ReRh nuclei. Blockade of the mPFC prevented freezing in the drug-free retention test as well as the increase of **i**) c-fos, arc, egr-1 and npas4 expression in the mPFC, **ii**) c-fos, arc, and npas4 in the vHIP, and **iii**) c-fos in the VMT (ReRh). Blockade of the vHIP also prevented freezing in the retention test, as well as the increase of **i**) c-fos, arc, egr-1 and npas4 expression in the mPFC and dHIP, **ii**) c-fos, arc, and npas4 in the vHIP, but did not alter the increased c-fos expression in the ReRh.

These data clearly evidence a contribution of the mPFC and vHIP to the CPFE, but also suggest a participation of the ReRh nuclei. Nevertheless, this principally correlative approach needs additional experiments using causality-investigating methods.

4.8.4. Inhibition of inherited defense reactions

Inactivation of the ventromedial prefrontal cortex (i.e. ILC and PLC) increases freezing after fear conditioning and reduces avoidance in a signaled active avoidance task (SAA). This part of the cortex has dense projections to the midline thalamus, including the Re. Using pharmacological and chemogenetic approaches, [Moscarello \(2020\)](#) demonstrated that the projections of the vmPFC to the Re are implicated in the suppression of freezing. Rats were trained to acquire the association between a sound (CS) and an unpleasant electrical shock (US) in a shuttle box. For additional training, the rats were given the possibility to avoid the shock and to stop the sound by shuttling from one to the other compartment. After 24 h, the rats were moved to a novel, non-divided context, where 10 CSs were presented. As avoidance was not possible, the rats froze. In a first experiment, hM4Di DREADD were expressed in the neurons of the vmPFC. When CNO was injected i.p., the freezing response was increased. In a second experiment using hM4Di DREADD in the vmPFC, rats were equipped with a canula targeting the Re to infuse CNO into the Re, thereby blocking terminals of vmPFC-to-Re projections. Intra-Re CNO infusion increased the freezing response. In a third experiment, muscimol was infused into the Re, which also increased freezing. Taken together, these results show that the vmPFC-to-Re projections are involved in the suppression of freezing and could play a role in the inhibition of inherited defensive reactions towards a threatening signal.

4.8.5. The Re is part of a visual circuit involved in spatial memory promoting effects of light treatment

Huang et al. (2021) tested the spatial memory of mice in an object location recognition task and in the water maze. In both tasks, mice showed evidence for spatial memory, but only if previously exposed to light treatment (2 h/day, 3000 lx, for 3 weeks; otherwise 200 lx during the light phase). Among other modifications, light treatment increased gamma oscillations in CA1 and c-Fos expression in both the HIP and Re. It also enhanced the spontaneous firing rate and the amplitude of miniature excitatory postsynaptic currents of Re neurons, among other effects. The effects of light on memory and gamma oscillations were disrupted by Re inactivation. The Re-mediated effects are under the control of glutamatergic neurons located in the ventral lateral geniculate nucleus and intergeniculate leaflet. Indeed, activation of these neurons, or activation of HIP-projecting Re neurons, or even activation of retinal ganglion cells projecting to the ventral lateral geniculate nucleus and intergeniculate leaflet was sufficient to mimic the memory-promoting effects of light treatment in the latter's absence. This report points to the Re as an important node of a subcortical visual circuit starting in the retina and ending up in the HIP, and which promotes spatial memory effects of light treatment.

5. ReRh nuclei and diseases (mainly preclinical models)

For discussion of an involvement of ReRh nuclei in diseases such as epilepsy and schizophrenia, see the review in the current issue by (Dolleman-van der Weel and Witter, 2020).

5.1. Alzheimer's disease

In 1991, Braak and Braak published results of a study performed on the brain of 12 patients suffering from Alzheimer's disease. Four of them has a Down's syndrome. Seven age-matched non-demented patients served as controls. Using silver techniques, Braak and Braak focused on the limbic nuclei of the thalamus and found a large number of extracellular amyloid deposits in nearly all thalamic nuclei. There were also numerous neurofibrillary tangles in the antero-dorsal nucleus, which was the most affected of all, as well as in the latero-dorsal nucleus, in portions of the intralaminar nuclei, and in both the paraventricular and Re nuclei. Altogether, these modifications most probably contribute to functional alterations which originate in a reduced information circulation within the limbic circuitry and could participate in the cognitive symptoms of the disease.

Recently, Walsh et al. (2020) have compared the spontaneous firing behavior of Re neurons recorded in wild type mice and in J20 mice, a popular mouse model overexpressing human A β , with highest expression levels in the cortex and the HIP (e.g., Webster et al., 2014). The mice were aged of 12–14 months, based on the fact that amyloid plaques begin to develop in the thalamus at about 13 months (Whitesell et al., 2019). Walsh et al. recorded neurons of the Re nucleus in slice preparations. They found a greater proportion (about 40 %) of Re neurons with hyperpolarized membrane potentials in J20 mice as compared to the 10 % observed in the wild type controls, without changes in the frequency of spontaneous action potentials. After hyperpolarizing-current stimuli, there was a rebound bursting for 500 ms to 1 s in about 40 % neurons of wild type mice, against close to 65 % neurons of J20 mice. Finally, the authors also found about 10 % reduction of the width of action potentials in J20 mice. Taken together, these modifications reflect hyperexcitability in the hippocampal-thalamo-cortical network, which could contribute to the cognitive deficits characterizing this model of Alzheimer's disease (e.

g., in long term recognition memory, as shown by Ameen-Ali et al. (2019), and spatial reference memory, as shown by Johnson and Kang (2016); Karl et al. (2012) and Mably et al. (2015)).

5.2. Depression

Kafetzopoulos et al. (2018) used NMDA lesions or tetracaine-induced reversible inactivations of the Re in rats subjected to the forced swim test (FST), a standard predictive test in the screening of antidepressant treatments. After Re lesions, there was a lower immobility level and a higher swimming time, suggesting antidepressant-like effects. These effects were mimicked by an injection of sertraline, an antidepressant drug. Furthermore, tetracaine-induced inactivation of the Re produced comparable effects. Forced swimming resulted in an about 450 % increase of c-Fos immunoreactive cells in the Re of intact rats. Next, Kafetzopoulos et al. investigated the effects of Re lesions (vs. or combined with a 3-week long daily sertraline treatment) on the consequences chronic mild stress (CMS, e.g. Dalla et al., 2005). CMS reduced the preference for sucrose, an effect reversed by Re lesion and sertraline treatment. CMS also increased the duration of immobility in the FST, an effect counterbalanced by the Re lesion or the drug. Both interventions reduced serum corticosterone levels. In the PFC, CMS induced an atrophy of dendrites and a reduction of spine density on the apical portion of the dendrites (in layers II and III of the PFC). Both effects were counterbalanced by Re lesions or sertraline treatment. When the lesions were performed during CMS regimen (i.e., after 4-weeks), they did not prevent anhedonia, and the hypothalamo-pituitary-adrenal axis remained disrupted. Altogether, these data indicate a role for the Re in the neurocircuitry of mood regulation with regard to stress, depression and resilience.

5.3. Alcohol abuse

Rodent models of thiamine deficiencies are used to mimic thalamic pathologies found in Wernicke-Korsakoff syndrome, often due to chronic alcohol abuse (e.g., Savage et al., 2020). In adult rats, an about 2-week thiamine deficient food diet produces marked neuronal loss in thalamic nuclei such as the anterodorsal, midline, intralaminar, posterior thalamus, anteroventral ventrolateral, gelatinosus, internal medullary lamina nuclei, and a few others in which damage is less marked (e.

g., Anzalone et al., 2010; Savage et al., 2020). The Re and Rh nuclei seem preserved (Bobal and Savage, 2015). In rat pups, however, the Re is a target for alcohol. In Gursky et al.'s (2019) study, female rat pups were given alcohol-containing milk via intragastric intubation (11.9 % v/v) twice a day between postnatal days 4 and 9. Average blood alcohol concentration was of 378 mg/dl. When aged of 72 days, the rats were killed, their brains sectioned, and slices stained with a neuronal marker. Neuronal and non-neuronal cells were counted in the Re and Rh. The Re, not the Rh, had shrunken and lost neuronal cells, whereas the number of non-neuronal cells was unchanged.

In a more recent study (Gursky et al., 2020), male and female rat pups aged of 7 days (PD7) were given a single dose of alcohol, and were killed at various delays. Twelve hours after alcohol intoxication, there was an increased apoptotic cell death in the Re of both female and male pups. By 4 days post-intoxication, the difference between pups given alcohol and their controls was no longer significant. In the rats killed 65 days post-intoxication, there was a cell loss in the Re not depending on the animals' sex. Rats given alcohol at PD7 had lost neurons in comparison with controls. The number of non-neuronal cells was also reduced, but in comparable proportions in alcohol and control rats. These data indicate a particular vulnerability of the Re to alcohol during prenatal development. The loss of Re neurons may account for a weaker hippocampo-cortical connectivity, which, in addition to classically-described hippocampal and neocortical damage, could participate in the cognitive dysfunctions observed in the fetal alcohol spectrum disorders.

5.4. Amyotrophic and primary lateral sclerosis

Amyotrophic (ALS) and primary (PLS) lateral sclerosis are neurodegenerative conditions characterized by progressive (relatively rapid in case of ALS, slower in case of PLS) motor neuron degeneration (upper and

lower ones in case of ALS, only upper ones in case of PLS). In a recent paper in humans, [Chipika et al. \(2020\)](#) paid attention to individual thalamic nuclei in both types of disease as compared to controls. They used MRI imaging to compare the volumetric profile of a variety of thalamic nuclei. An exhaustive summary of their findings is beyond the scope of the current review. However, more in line with this scope is their observation that an ensemble made of the mediodorsal, paratenial and Re nuclei had undergone considerable shrinkage. The authors hypothesized that this degeneration-reflecting shrinkage could contribute to the neuropsychological alterations usually associated with ALS, namely deficits in executive functions, social cognition and memory.

6. Conclusion

The connectivity patterns of the Re and the Rh share similarities, but there are also differences (see [Figs. 1–4](#)). Despite these differences, the efferent and afferent connections each nucleus establishes with many brain structures make them a real crossroads, in which the bidirectional information flow between the HIP and the mPFC is crucial to a panel of cognitive functions. It is noteworthy that the Re and Rh nuclei are not the only neuroanatomical option to permit information transfer between the mPFC and the HIP, as there is a direct monosynaptic projection from the HIP to the mPFC, as well as indirect, at least disynaptic, connections from the mPFC to the HIP relaying in the VTA, amygdala, PRC, and EC (e.g., [Jin and Maren, 2015](#); [Maren, 2011](#); [Russo and Nestler, 2013](#); [Wolff et al., 2015](#)). As far as the Re or Rh nucleus is concerned, the flow of information between the mPFC and the HIP is probably neither tonic nor permanent and, as depicted herein and in other reviews (e.g., [Dolleman-van der Weel et al., 2019](#); [Griffin, 2015](#); [Pereira de Vasconcelos and Cassel, 2015](#); [Vertes et al., 2015](#)), it depends on what an animal is processing ‘off-line’ or ‘on-line’. ‘Off-line’ concerns a mental process set in action after its related event is over. Consolidation, reconsolidation, systems-level consolidation are examples of it. ‘On-line’ relates to a mental process set in action to support an ongoing event; spatial working memory is a typical example.

Recording of field potentials in the mPFC and HIP highlight particular oscillation frequencies, but also a coherence between them, pointing to privileged, ongoing behavior-dependent windows of bidirectional information transfer from one to the other structure. Thus, for example, the transfer of information from the HIP to the mPFC is correlated with a coherent theta-type oscillation, while that of information from the mPFC towards the HIP is accompanied by slower, still coherent oscillations. The fact that a small proportion of the cells of the Re presents, in the awake and freely-moving animal, an activity profile close to that of certain hippocampal cells (e.g., place cells) or cells from other structures involved in spatial navigation (e.g., head direction cells) suggests that some of the navigation-related information passing through the Re could do so without undergoing dramatic modification of information content.

Functionally, we have seen that ReRh nuclei intervene in a large number of cognitive functions including information encoding, information generalization, attention, spatial working memory, memory consolidation, its reconsolidation or extinction, and a few others, such as the sequence of events in a memory of successive olfactory items. It is this functional multiplicity at the behavioral level that leads us to see in these nuclei kind of a ‘surprising versatility’: ‘versatility’ because they participate in a large range of cognitive functions, and ‘surprising’ because such multiple contributions are perhaps not that common in most brain nuclei. However, this functional diversity is very compatible with the rich variety of connections that these nuclei establish with other brain structures, whether in terms of efferents or afferents. Upon closer inspection, however formidably diverse the aforementioned functions may be, most of them have in common a conjoint engagement of both the mPFC and the HIP, and most probably a dependence on a finely-tuned cooperation between these 2 structures that could go up to genuine synergistic interactions.

However, the Re and Rh nuclei have also implications that do not concern information flow between the HIP and mPFC. For instance, the Re is implicated

in reversal learning, which presumably engages its connections with the orbitofrontal cortex (e.g., [Linley et al., 2016](#)). Further ideas and studies should pave our way to better understanding of the functional implications of the ReRh nuclei and, more importantly, the underlying mechanisms. For instance, and this is a first point, the ReRh nuclei are not the only thalamic nuclei having connections with the PFC and/or HIP. Therefore, a next possible step in the thinking and experimental research constructions about the Re and Rh nuclei might focus on what is overlapping (should the case arise) and what is not, in functional terms, between these nuclei and other ones, perhaps in a way close to what [Mathiasen et al. \(2020\)](#) have done when comparing the anterior thalamic nuclei and the Re. From a cognitive point of view, and even more in relation with memory, the reader interested in functions not affected by experimental manipulation of the ReRh might take a look at this review article.

A second point concerns the connectivity pattern of the Re and Rh nuclei. The tools, especially viral tools, enabling selective disconnections between a given afferent or efferent region of the Re or Rh, or opto- or pharmacogenetic stimulations/inhibitions of their interconnections are largely validated, and can now be used to functionally dissect this complex system in view of the diversity of its implications. The goal here is to identify possible modules with specific functional implications. Indeed, among all functions affected by a lesion of the ReRh nuclei, it seems conceivable that a subgroup of ReRh neurons could be dedicated to one of these functions without contributing to the other ones. A first step towards the exploration of such a possibility could be supported by e.g., ‘omics’ approaches, which have started to be used for investigating the organization of other thalamic nuclei, including at a single cell-resolution level (e.g., [Li et al., 2020](#); [Nagalski et al., 2016](#)). Such methodological options could lead to the identification of specific molecular signatures of neuronal ensembles in the ReRh nuclei, of which the functional implications could then be investigated with a yet unachieved precision.

A third point concerns connectivity patterns and functions of each nucleus, and perhaps even more the distribution of neuronal ensembles therein. Indeed, beyond their similarities, the differences between the connection patterns and distribution of neurons in these nuclei call for research aiming to identify in what, exactly, connectivity of neuronal ensembles functionally differ.

A fourth point is arising from the fact that, in this review, we focused on the link between one or both thalamic nuclei of the VMT and a relatively rich palette of cognitive functions. In no case should this choice be regarded as pointing towards an implication of only these nuclei in each of these different functions, with exclusion of other brain regions. ReRh lesion, inactivation or disconnection produces deficits that can, at least qualitatively, also be induced with lesion, inactivation or disconnection of other structures of the brain. Such similarities open a horizon to research aiming to understand whether the resemblance between the consequences of these different experimental manipulations is to be attributed to the rupture of a circuit of which the ReRh would ultimately be only one link among several others, or to a different anatomo-functional organization.

A fifth point brings us back to the connectivity patterns of both nuclei with a large variety of cortical and subcortical brain structures. Within this pattern, both nuclei occupy a nodal position, as suggested by the bidirectional connections they establish with several of such structures. This neuroanatomical organization could enable one or both nuclei to participate in combining information from different functional sources, and thereby to allow an organism to produce a particular behavior, of which the complexity would require to take into account, at the same time, operations that occur in parallel within different information-processing systems. This proposal is speculative, although it appears compatible with the fact that the ReRh nuclei are of the higher order type, and with findings showing that consequences of lesions of these nuclei can also be obtained with damage to other brain regions with which they are bridged (see above). For instance, [Cholvin et al. \(2013\)](#) showed that strategy shifting in a navigation task could be altered by lesions of the mPFC, of the dorsal hippocampus, or of the ReRh nuclei. Studies in behaving animals, which would focus on oscillation coherence between

different components of a circuit encompassing the ReRh nuclei could support further explorations of this possibility.

Finally, we have considered characteristics or aspects of several disorders or diseases, including neurodegenerative ones. In the current issue, (Dolleman-van der Weel and Witter, 2020) have specifically focused on possible implications of Re dysfunctions in epilepsy and schizophrenia. Alzheimer's disease, mood disorders, consequences of intrauterine exposure to alcohol, ALS are other leads. Therefore, it is well conceivable that a better understanding of what the Re and probably the Rh nuclei actually do, and how they do this within a complex system of multiple interconnectivities, will contribute to build useful bridges between preclinical research and future therapeutic applications.

Declaration of Competing Interest

The authors have no conflict of interest to declare regarding the content of the current review.

Acknowledgements

The authors acknowledge support by the University of Strasbourg, the University of Aix-Marseille, the CNRS and the INSERM. They are grateful to Delphine Cochand for her corrections in a previous version of this manuscript. Work of some authors of the current review (J.-C.C., A. PdV., T.C., A.S.) has been supported by an ANR grant (ANR THALAME, Grant 14-CE13-0029-01) coordinated by J.-C.C. Other authors were supported by an INSERM starting grant coordinated by P.P.Q. and by the Fondation pour la Recherche Medicale (M.F.; Grant FDT201805005246).

References

Ali, M., Cholvin, T., Muller, M.A., Cosquer, B., Kelche, C., Cassel, J.C., Pereira de Vasconcelos, A., 2017. Environmental enrichment enhances systems-level consolidation of a spatial memory after lesions of the ventral midline thalamus. *Neurobiol. Learn. Mem.* 141, 108–123. <https://doi.org/10.1016/j.nlm.2017.03.021>.

Ameen-Ali, K.E., Simpson, J.E., Wharton, S.B., Heath, P.R., Sharp, P.S., Brezzo, G., Berwick, J., 2019. The time course of recognition memory impairment and glial pathology in the hAPP-J20 mouse model of Alzheimer's disease. *J. Alzheimers Dis.* 68 (2), 609–624. <https://doi.org/10.3233/JAD-181238>.

Anzalone, S., Vetreno, R.P., Ramos, R.L., Savage, L.M., 2010. Cortical cholinergic abnormalities contribute to the amnesic state induced by pyriithiamine-induced thiamine deficiency in the rat. *Eur. J. Neurosci.* 32 (5), 847–858. <https://doi.org/10.1111/j.1460-9568.2010.07358.x>.

Apergis-Schoute, J., Aline Pinto, A., Denis Pare, D., 2006. Ultrastructural organization of medial prefrontal inputs to the rhinal cortices. *Eur. J. Neurosci.* 24 (1), 135–144. <https://doi.org/10.1111/j.1460-9568.2006.04894.x>.

Arai, R., Jacobowitz, D.M., Deura, S., 1994. Distribution of calretinin, calbindin-D28k, and parvalbumin in the rat thalamus. *Brain Res. Bull.* 33 (5), 595–614. [https://doi.org/10.1016/0361-9230\(94\)90086-8](https://doi.org/10.1016/0361-9230(94)90086-8).

Asok, A., Kandel, E.R., Rayman, J.B., 2019. The neurobiology of fear generalization. *Front. Behav. Neurosci.* 12, 329. <https://doi.org/10.3389/fnbeh.2018.00329>.

Baddeley, A.D., 1986. Working Memory. Oxford University Press, Oxford, UK. <https://doi.org/10.1002/acp.2350020209>.

Baram, T.Z., Donato, F., Holmes, G.L., 2019. Construction and disruption of spatial memory networks during development. *Learn. Mem.* 26 (7), 206–218. <https://doi.org/10.1101/jm.049239.118>.

Barker, G.R.I., Warburton, E.C., 2018. A critical role for the nucleus reuniens in long-term, but not short-term associative recognition memory formation. *J. Neurosci.* 38 (13), 3208–3217. <https://doi.org/10.1523/JNEUROSCI.1802-17.2017>.

Bayer, L., Serafin, M., Eggermann, E., Saint-Mleux, B., Machard, D., Jones, B.E., Mühlethaler, M., 2004. Exclusive postsynaptic action of hypocretin-orexin on sublayer 6b cortical neurons. *J. Neurosci.* 24 (30), 6760–6764. <https://doi.org/10.1523/JNEUROSCI.1783-04.2004>.

Bell, M.E., Seema Bhatnagar, S., Akana, S.F., SuJean Choi, S., Mary, F., Dallman, M.F., 2000. Disruption of Arcuate/Paraventricular nucleus connections changes body energy balance and response to acute stress. *J. Neurosci.* 20 (17), 6707–6713. <https://doi.org/10.1523/JNEUROSCI.20-17-06707.2000>.

Bentivoglio, M., Balerica, G., Kruger, L., 1991. The specificity of the non-specific thalamus: the midline nuclei. *Prog. Brain Res.* 87, 53–80. [https://doi.org/10.1016/s0079-6123\(08\)63047-2](https://doi.org/10.1016/s0079-6123(08)63047-2).

Bertram, E.H., Mangan, P.S., Zhang, D.X., Scott, C.A., Williamson, J.M., 2001. The midline thalamus: alterations and a potential role in limbic epilepsy. *Epilepsia* 42, 967–978. <https://doi.org/10.1046/j.1528-1157.2001.042008967.x>.

Bertram, E.H., Zhang, D.X., 1999. Thalamic excitation of hippocampal CA1 neurons: a comparison with the effects of CA3 stimulation. *Neuroscience* 92, 15–26. [https://doi.org/10.1016/s0306-4522\(98\)00712-x](https://doi.org/10.1016/s0306-4522(98)00712-x).

Bitzenhofer, S.H., Sieben, K., Siebert, K.D., Spehr, M., Hanganu-Opatz, I.L., 2015. Oscillatory activity in developing prefrontal networks results from theta-gamma-modulated synaptic inputs. *Cell Rep.* 11 (3), 486–497. <https://doi.org/10.1016/j.celrep.2015.03.031>.

Bjerknes, T.L., Dagslott, N.C., Moser, E.I., Moser, M.B., 2018. Path integration in place cells of developing rats. *Proc. Natl. Acad. Sci. U.S.A.* 115 (7), E1637–E1646. <https://doi.org/10.1073/pnas.1719054115>.

Blanchard, D.C., Hynd, A.L., Minke, K.A., Minemoto, T., Blanchard, R.J., 2001. Human defensive behaviors to threat scenarios show parallels to fear- and anxiety-related defense patterns of non-human mammals. *Neurosci. Biobehav. Rev.* 25 (7–8), 761–770. [https://doi.org/10.1016/s0149-7634\(01\)00056-2](https://doi.org/10.1016/s0149-7634(01)00056-2).

Bobal, M.G., Savage, L.M., 2015. The role of ventral midline thalamus in cholinergic-based recovery in the amnesic rat. *Neuroscience* 285, 260–268. <https://doi.org/10.1016/j.neuroscience.2014.11.015>.

Bokor, H., Csaki, A., Kocsis, K., Kiss, J., 2002. Cellular architecture of the nucleus reuniens thalami and its putative aspartatergic/glutamatergic projection to the hippocampus and medial septum in the rat. *Eur. J. Neurosci.* 16 (7), 1227–1239. <https://doi.org/10.1046/j.1460-9568.2002.02189.x>.

Bower, A.J., 1990. Plasticity in the adult and neonatal central nervous system. *Br. J. Neurosurg.* 4 (4), 253–264. <https://doi.org/10.3109/02688699008992734>.

Braak, H., Braak, E., 1991. Alzheimer's disease affects limbic nuclei of the thalamus. *Acta Neuropathol.* 81 (3), 261–268. <https://doi.org/10.1007/BF00305867>.

Brockmann, M.D., Poschel, B., Cichon, N., Hanganu-Opatz, I.L., 2011. Coupled oscillations mediate directed interactions between prefrontal cortex and hippocampus of the neonatal rat. *Neuron* 71 (2), 332–347. <https://doi.org/10.1016/j.neuron.2011.05.041>.

Cassel, J.C., Pereira de Vasconcelos, A., Loureiro, M., Cholvin, T., Dalrymple-Alford, J.C., Vertes, R.P., 2013. The reuniens and rhomboid nuclei: neuroanatomy, electrophysiological characteristics and behavioral implications. *Prog. Neurobiol.* 111, 34–52. <https://doi.org/10.1016/j.pneurobio.2013.08.006>.

Chipika, R.H., Finegan, E., Li, H., Shing, S., McKenna, M.C., Christidi, F., Chang, K.M., Doherty, M.A., Hengeveld, J.C., Vajda, A., Pender, N., Hutchinson, S., Donaghy, C., McLaughlin, R.L., Hardiman, O., Bede, P., 2020. Switchboard malfunctions in motor neuron diseases: selective pathology of thalamic nuclei in amyotrophic lateral sclerosis and primary lateral sclerosis. *Neuroimage Clin.* 27, 102300. <https://doi.org/10.1016/j.nicl.2020.102300>.

Cholvin, T., 2014. Role d'un Circuit Hippocamp-cortico-thalamique Dans Les Processus De Mémoire Spatiale Chez Le Rat. PhD Thesis. University of Strasbourg, Strasbourg, France.

Cholvin, T., Loureiro, M., Cassel, R., Cosquer, B., Geiger, K., De Sa Nogueira, D., Raingard, H., Robelin, L., Kelche, C., Pereira de Vasconcelos, A., Cassel, J.C., 2013. The ventral midline thalamus contributes to strategy shifting in a memory task requiring both prefrontal cortical and hippocampal functions. *J. Neurosci.* 33, 8772–8783. <https://doi.org/10.1523/JNEUROSCI.0771-13.2013>.

Cholvin, T., Hok, V., Giorgi, L., Chaillan, F.A., Poucet, B., 2018. Ventral midline thalamus is necessary for hippocampal place field stability and cell firing modulation. *J. Neurosci.* 38 (1), 158–172. <https://doi.org/10.1523/JNEUROSCI.2039-17.2017>.

Churchwell, J., Kesner, R.P., 2011. Hippocampal-prefrontal dynamics in spatial working memory: interactions and independent parallel processing. *Behav. Brain Res.* 225 (2), 389–395. <https://doi.org/10.1016/j.bbr.2011.07.045>.

Cohen, N., Pell, L., Edelson, M.G., Ben-Yakov, A., Pine, A., Dudai, Y., 2015. Peri-encoding predictors of memory encoding and consolidation. *Neurosci. Biobehav. Rev.* 50, 128–142. <https://doi.org/10.1016/j.neubiorev.2014.11.002>.

D'Esposito, M., Postle, B.R., 2015. The cognitive neuroscience of working memory. *Annu. Rev. Psychol.* 66, 115–142. <https://doi.org/10.1146/annurev-psych-010814-015031>.

Dalla, C., Antoniou, K., Drossopoulou, G., Xagoraris, M., Kokras, N., Sfrikakis, A., Papadopoulou-Daifoti, Z., 2005. Chronic mild stress impact: are females more vulnerable? *Neuroscience* 135 (3), 703–714. <https://doi.org/10.1016/j.neuroscience.2005.06.068>.

Dempsey, E.W., Morison, R.S., 1942. The production of rhythmically cortical recurrent potentials after localized thalamic stimulation. *Am. J. Physiol.* 135, 293–300.

Dolleman-van der Weel, M.J., Lopes da Silva, F.H., Witter, M.P., 1997. Reuniens nucleus thalami modulates activity in hippocampal field CA1 through excitatory and inhibitory mechanisms. *J. Neurosci.* 17, 5640–5650. <https://doi.org/10.1523/JNEUROSCI.17-14-05640.1997>.

Dolleman-van der Weel, M.J., Morris, R.G.M., Witter, M.P., 2009. Neurotoxic lesions of the thalamic reuniens or mediodorsal nucleus in rats affect non-mnemonic aspects of water maze learning. *Brain Struct. Funct.* 213, 329–342. <https://doi.org/10.1007/s00429-008-0200-6>.

- Dolleman-van der Weel, M.J., Lopes da Silva, F.H., Witter, M.P., 2017. Interaction of nucleus reuniens and entorhinal cortex projections in hippocampal field CA1 of the rat. *Brain Struct. Funct.* 222 (5), 2421–2438. <https://doi.org/10.1007/s00429-016-1350-6>.
- Dolleman-van der Weel, M.J., Griffin, A.L., Ito, H.T., Shapiro, M.L., Witter, M.P., Robert, P., Vertes, R.P., Timothy, A., Allen, T.A., 2019. The nucleus reuniens of the thalamus sits at the nexus of a hippocampus and medial prefrontal cortex circuit enabling memory and behavior. *Learn. Mem.* 26 (7), 191–205. <https://doi.org/10.1101/lm.048389.118>.
- Dolleman-van der Weel, M.J., Witter, M.P., 1996. Projections from the nucleus reuniens thalami to the entorhinal cortex, hippocampal field CA1, and the subiculum in the rat arise from different populations of neurons. *J. Comp. Neurol.* 364 (4), 637–650. [https://doi.org/10.1002/\(SICI\)1096-9861\(19960122\)364:4<637::AID-CNE3>3.0.CO;2-4](https://doi.org/10.1002/(SICI)1096-9861(19960122)364:4<637::AID-CNE3>3.0.CO;2-4).
- Dolleman-van der Weel, M.J., Witter, M.P., 2020. The thalamic midline nucleus reuniens: potential relevance for schizophrenia and epilepsy. *Neurosci Biobehav Rev* 119 (the cognitive thalamus), 422–439. <https://doi.org/10.1016/j.neubiorev.2020.09.033>.
- Duan, A.R., Varela, C., Zhang, Y., Shen, Y., Xiong, L., Wilson, M.A., Lisman, J., 2015. Delta frequency optogenetic stimulation of the thalamic nucleus reuniens is sufficient to produce working memory deficits: relevance to schizophrenia. *Biol. Psychiatry* 77 (12), 1098–1107. <https://doi.org/10.1016/j.biopsych.2015.01.020>.
- Dudchenko, P.A., 2004. An overview of the tasks used to test working memory in rodents. *Neurosci. Biobehav. Rev.* 28 (7), 699–709. <https://doi.org/10.1016/j.neubiorev.2004.09.002>.
- Eleore, L., Lopez-Ramos, J.C., Guerra-Narbona, R., Delgado-García, J.M., 2011. Role of reuniens nucleus projections to the medial prefrontal cortex and to the hippocampal pyramidal CA1 area in associative learning. *PLoS One* 6, 1–11. <https://doi.org/10.1371/journal.pone.0023538>.
- Ferini, F., Thiery, A.M., Glowinski, J., 1987. Anatomical and electrophysiological evidence for a direct projection from Ammon's horn to the medial prefrontal cortex in the rat. *Exp. Brain Res.* 65 (2), 421–426. <https://doi.org/10.1007/BF00236315>.
- Ferraris, M., Cassel, J.C., Pereira de Vasconcelos, A., Stephan, A., Quilichini, P.P., 2021. The nucleus reuniens, a thalamic relay for cortico-hippocampal interaction in recent and remote memory consolidation. *Neurosci Biobehav Rev* 125 (the cognitive thalamus), 339–354. <https://doi.org/10.1016/j.neubiorev.2021.02.025>.
- Ferraris, M., Ghestem, A., Vicente, A.F., Nallet-Khosrofiyan, L., Bernard, C., Quilichini, P. P., 2018. The nucleus reuniens controls long-range hippocampo-prefrontal gamma synchronization during slow oscillations. *J. Neurosci.* 38 (12), 3026–3038. <https://doi.org/10.1523/JNEUROSCI.3058-17.2018>.
- Fillingner, C., Yalcin, I., Barot, M., Veinante, P., 2017. Afferents to anterior cingulate areas 24a and 24b and midcingulate areas 24a' and 24b' in the mouse. *Brain Struct. Funct.* 222 (3), 1509–1532. <https://doi.org/10.1007/s00429-016-1290-1>.
- Fizet, J., Cassel, J.C., Kelche, C., Meunier, H., 2016. A review of the 5-Choice Serial Reaction Time (5-CSRT) task in different vertebrate models. *Neurosci. Biobehav. Rev.* 71, 135–153. <https://doi.org/10.1016/j.neubiorev.2016.08.027>.
- Frankland, P.W., Bontempi, B., 2005. The organization of recent and remote memories. *Nat. Rev. Neurosci.* 6 (2), 119–130. <https://doi.org/10.1038/nrn1607>.
- Freund, T.F., Buzsáki, G., 1996. Interneurons of the hippocampus. *Hippocampus* 6 (4), 347–470. [https://doi.org/10.1002/\(SICI\)1098-1063\(1996\)6:4<347::AID-HIPO1>3.0.CO;2-I](https://doi.org/10.1002/(SICI)1098-1063(1996)6:4<347::AID-HIPO1>3.0.CO;2-I).
- Fujisawa, S., Buzsáki, G., 2011. A 4 Hz oscillation adaptively synchronizes prefrontal, VTA, and hippocampal activities. *Neuron* 72 (1), 153–165. <https://doi.org/10.1016/j.neuron.2011.08.018>.
- Gazarini, L., Stern, C.A., Carobrez, A.P., Bertoglio, L.J., 2013. Enhanced noradrenergic activity potentiates fear memory consolidation and reconsolidation by differentially recruiting α 1- and β -adrenergic receptors. *Learn. Mem.* 20 (4), 210–219. <https://doi.org/10.1101/lm.030007.112>.
- Gazarini, L., Stern, C.A., Piornedo, R.R., Takahashi, R.N., Bertoglio, L.J., 2014. PTSD-like memory generated through enhanced noradrenergic activity is mitigated by a dual step pharmacological intervention targeting its reconsolidation. *Int. J. Neuropsychopharmacol.* 18 (1), pyu026. <https://doi.org/10.1093/ijnp/pyu026>.
- Griffin, A.L., 2015. Role of the thalamic nucleus reuniens in mediating interactions between the hippocampus and medial prefrontal cortex during spatial working memory. *Front. Syst. Neurosci.* 9. <https://doi.org/10.3389/fnsys.2015.00029> article 29.
- Groenewegen, H.J., Berendse, H.W., 1994. The specificity of the 'non specific' midline and intralaminar thalamic nuclei. *Trends Neurosci.* 17, 52–57. [https://doi.org/10.1016/0166-2236\(94\)90074-4](https://doi.org/10.1016/0166-2236(94)90074-4).
- Gursky, Z.H., Lisa, M., Savage, L.M., Anna, Y., Klintsova, A.Y., 2019. Nucleus reuniens of the midline thalamus of a rat is specifically damaged after early postnatal alcohol exposure. *Neuroreport* 30 (10), 748–752. <https://doi.org/10.1097/WNR.0000000000001270>.
- Gursky, Z.H., Spillman, E.C., Klintsova, A.Y., 2020. Single-day postnatal alcohol exposure induces apoptotic cell death and causes long-term neuron loss in rodent thalamic nucleus reuniens. *Neuroscience* 435, 124–134. <https://doi.org/10.1016/j.neuroscience.2020.03.046>.
- Hallock, H.L., Wang, A., Griffin, A.L., 2016. Ventral midline thalamus is critical for hippocampal-prefrontal synchrony and spatial working memory. *J. Neurosci.* 36 (32), 8372–8389. <https://doi.org/10.1523/JNEUROSCI.0991-16.2016>.
- Hartung, H., Brockmann, M.D., Poschel, B., De Feo, V., Hanganu-Opatz, I.L., 2016. Thalamic and entorhinal network activity differently modulates the functional development of prefrontal-hippocampal interactions. *J. Neurosci.* 36 (13), 3676–3690. <https://doi.org/10.1523/JNEUROSCI.3232-15.2016>.
- Hauer, B.E., Pagliardini, S., Dickson, C.T., 2019. The reuniens nucleus of the thalamus has an essential role in coordinating slow-wave activity between neocortex and hippocampus. *eNeuro* 6 (5). <https://doi.org/10.1523/ENEURO.0365-19.2019>.
- Hay, Y.A., Andjelic, S., Badr, S., Lambolez, B., 2015. Orexin-dependent activation of layer V/b enhances cortical network activity and integration of non-specific thalamocortical inputs. *Brain Struct. Funct.* 220 (6), 3497–3512. <https://doi.org/10.1007/s00429-014-0869-7>.
- Hay, Y.A., Naude, J., Faure, P., Lambolez, B., 2019. Target interneuron preference in thalamocortical pathways determines the temporal structure of cortical responses. *Cereb. Cortex* 29 (7), 2815–2831. <https://doi.org/10.1093/cercor/bhy148>.
- Herkenham, M., 1978. The connections of the reuniens nucleus thalamus: evidence for a direct thalamo-hippocampal pathway in the rat. *J. Comp. Neurol.* 177, 589–610. <https://doi.org/10.1002/cne.901770405>.
- Herkenham, M., 1980. Laminar organization of thalamic projections to the rat neocortex. *Science* 207, 532–535. <https://doi.org/10.1126/science.7352263>.
- Heroux, N.A., Horgan, C.J., Pinizzotto, C.C., Rosen, J.B., Stanton, M.E., 2019. Medial prefrontal and ventral hippocampal contributions to incidental context learning and memory in adolescent rats. *Neurobiol. Learn. Mem.* 166, 107091. <https://doi.org/10.1016/j.nlm.2019.107091>.
- Hirayasu, Y., Wada, J.A., 1992a. N-methyl-D-aspartate injection into the massa intermedia facilitates development of limbic kindling in rats. *Epilepsia* 33, 965–970. <https://doi.org/10.1111/j.1528-1125.1992.tb01745.x>.
- Hirayasu, Y., Wada, J.A., 1992b. Convulsive seizures in rats induced by N-methyl-D-aspartate injection into the massa intermedia. *Brain Res.* 577, 36–40. [https://doi.org/10.1016/0006-8993\(92\)90534-g](https://doi.org/10.1016/0006-8993(92)90534-g).
- Hoover, W.B., Vertes, R.P., 2007. Anatomical analysis of afferent projections to the medial prefrontal cortex in the rat. *Brain Struct. Funct.* 212 (2), 149–179. <https://doi.org/10.1007/s00429-007-0150-4>.
- Hoover, W.B., Vertes, R.P., 2012. Collateral projections from reuniens nucleus of thalamus to hippocampus and medial prefrontal cortex in the rat: a single and double retrograde fluorescent labeling study. *Brain Struct. Funct.* 217, 191–209. <https://doi.org/10.1007/s00429-011-0345-6>.
- Hsu, D.T., Price, J.L., 2007. Midline and intralaminar thalamic connections with the orbital and medial prefrontal networks in macaque monkeys. *J. Comp. Neurol.* 504, 89–111. <https://doi.org/10.1002/cne.21440>.
- Huang, X., Huang, P., Huang, L., Hu, Z., Liu, X., Shen, J., Xi, Y., Yang, Y., Fu, Y., Tao, Q., Lin, S., Xu, A., Xu, F., Xue, T., So, K.F., Li, H., Ren, C., 2021. A visual circuit related to the nucleus reuniens for the spatial-memory-promoting effects of light treatment. *Neuron* 109, 1–16. <https://doi.org/10.1016/j.neuron.2020.10.023>.
- Hyman, J.M., Zilli, E.A., Paley, A.M., Hasselmo, M.E., 2005. Medial prefrontal cortex cells show dynamic modulation with the hippocampal theta rhythm dependent on behavior. *Hippocampus* 15 (6), 739–749. <https://doi.org/10.1002/hipo.20106>.
- Igarashi, K.M., Lu, L., Colgin, L.L., Moser, M.B., Moser, E.I., 2014. Coordination of entorhinal-hippocampal ensemble activity during associative learning. *Nature* 510 (7503), 143–147. <https://doi.org/10.1038/nature13162>.
- Ito, H.T., Zhang, S.-J., Witter, M.P., Moser, E.I., Moser, M.-B., 2015. A prefrontal-thalamo-hippocampal circuit for goal-directed spatial navigation. *Nature* 522 (7554), 50–55. <https://doi.org/10.1038/nature14396>.
- Ito, H.T., Moser, E.I., Moser, M.-B., 2018. Supramammillary nucleus modulates spike-time coordination in the prefrontal-thalamo-hippocampal circuit during navigation. *Neuron* 99 (3), 576–587. <https://doi.org/10.1016/j.neuron.2018.07.021> e5.
- Jankowski, M.M., Islam, M.N., Wright, N.F., Vann, S.D., Erichsen, J.T., Aggleton, J.P., O'Mara, S.M., 2014. Nucleus reuniens of the thalamus contains head direction cells. *Elife* 3, e03075. <https://doi.org/10.7554/eLife.03075>.
- Jankowski, M.M., Passecker, J., Islam, M.N., Vann, S.D., Erichsen, J.T., Erichsen, J.T., Aggleton, J.P., O'Mara, S.M., 2015. Evidence for spatially-responsive neurons in the rostral thalamus. *Front. Behav. Neurosci.* 9, 256. <https://doi.org/10.3389/fnbeh.2015.00256>.
- Jay, T.M., Witter, M.P., 1991. Distribution of hippocampal CA1 and subicular efferents in the prefrontal cortex of the rat studied by means of anterograde transport of Phaseolus vulgaris-leucoagglutinin. *J. Comp. Neurol.* 313 (4), 574–586. <https://doi.org/10.1002/cne.903130404>.
- Jayachandran, M., Linley, S.B., Schlecht, M., Mahler, S.V., Vertes, R.P., Allen, T.A., 2019. Prefrontal pathways provide top-down control of memory for sequences of events. *Cell Rep.* 28 (3), 640–654. <https://doi.org/10.1016/j.celrep.2019.06.053> e6.

- Jedlicka, P., Hoon, M., Papadopoulos, T., Vlachos, A., Winkels, R., Pouloupoulos, A., Betz, H., Deller, T., Brose, N., Varoqueaux, F., Schwarzscher, S.W., 2011. Increased dentate gyrus excitability in neuroligin-2-deficient mice in vivo. *Cereb. Cortex* 21 (2), 357–367. <https://doi.org/10.1093/cercor/bhq100>. Epub 2010 Jun 7.
- Jin, J., Maren, S., 2015. Prefrontal-hippocampal interactions in memory and emotion. *Front. Syst. Neurosci.* 9, 170. <https://doi.org/10.3389/fnsys.2015.00170>.
- Johnson, E.C.B., Kang, J., 2016. A small molecule targeting protein translation does not rescue spatial learning and memory deficits in the hAPP-J20 mouse model of Alzheimer's disease. *Peer J* 4, e2565. <https://doi.org/10.7717/peerj.2565>. eCollection2016.
- Jones, M.W., Wilson, M.A., 2005. Theta rhythms coordinate hippocampal-prefrontal interactions in a spatial memory task. *PLoS Biol.* 3 (12), e402. <https://doi.org/10.1371/journal.pbio.0030402>.
- Jung, D., Huh, Y., Cho, J., 2019. The ventral midline thalamus mediates hippocampal spatial information processes upon spatial cue changes. *J. Neurosci.* 39 (12), 2276–2290. <https://doi.org/10.1523/JNEUROSCI.2127-18.2019>.
- Kafetzopoulos, V., Kokras, N., Sotiropoulos, I., Oliveira, J.F., Leite-Almeida, H., Vasalou, A., Sardinha, V.M., Papadopoulou-Daifoti, Z., Almeida, O.F.X., Antoniou, K., Sousa, N., Dalla, C., 2018. The nucleus reuniens: a key node in the neurocircuitry of stress and depression. *Mol. Psychiatry* 23 (3), 579–586. <https://doi.org/10.1038/mp.2017.55>.
- Karl, T., Bhatia, S., Cheng, D., Kim, W.S., Garner, B., 2012. Cognitive phenotyping of amyloid precursor protein transgenic J20 mice. *Behav. Brain Res.* 228 (2), 392–397. <https://doi.org/10.1016/j.bbr.2011.12.021>.
- Kassam, S.M., Herman, P.M., Goodfellow, N.M., Alves, N.C., Lambe, E.K., 2008. Developmental excitation of corticothalamic neurons by nicotinic acetylcholine receptors. *J. Neurosci.* 28 (35), 8756–8764. <https://doi.org/10.1523/JNEUROSCI.2645-08.2008>.
- Kerr, K.M., Agster, K.L., Furtak, S.C., Burwell, R.D., 2007. Functional neuroanatomy of the parahippocampal region: the lateral and medial entorhinal areas. *Hippocampus* 17 (9), 697–708. <https://doi.org/10.1002/hipo.20315>.
- Klein, M.M., Cholvin, T., Cosquer, B., Salvadori, A., Le Mero, J., Kourouma, L., Boufillier, A.L., Pereira de Vasconcelos, A., Cassel, J.C., 2019. Ventral midline thalamus lesion prevents persistence of new (learning-triggered) hippocampal spines, delayed neocortical spinogenesis, and spatial memory durability. *Brain Struct. Funct.* 224 (4), 1659–1676. <https://doi.org/10.1007/s00429-019-01865-1>.
- Kondrakiewicz, S., Kostecki, M., Szadzinska, W., Knapka, E., 2019. Ecological validity of social interaction tests in rats and mice. *Genes Brain Behav.* 18 (1), e12525. <https://doi.org/10.1111/gbb.12525>.
- Krout, K.E., Loewy, A.D., 2000. Parabrachial nucleus projections to midline and intralaminar thalamic nuclei of the rat. *J. Comp. Neurol.* 428 (3), 475–494. [https://doi.org/10.1002/1096-9861\(20001218\)428:3<475::aid-cne6>3.0.co;2-9](https://doi.org/10.1002/1096-9861(20001218)428:3<475::aid-cne6>3.0.co;2-9).
- Krout, K.E., Belzer, R.E., Loewy, A.D., 2002. Brainstem projections to midline and intralaminar thalamic nuclei of the rat. *J. Comp. Neurol.* 448, 53–101. <https://doi.org/10.1002/cne.10236>.
- Kubota, Y., Shigematsu, N., Karube, F., Sekigawa, A., Kato, S., Yamaguchi, N., Hirai, Y., Morishima, M., Kawaguchi, Y., 2011. Selective coexpression of multiple chemical markers defines discrete populations of neocortical GABAergic neurons. *Cereb. Cortex* 21 (8), 1803–1817. <https://doi.org/10.1093/cercor/bhq252>.
- Kwapis, J.L., Wood, M.A., 2014. Epigenetic mechanisms in fear conditioning: implications for treating post-traumatic stress disorder. *Trends Neurosci.* 37 (12), 706–720. <https://doi.org/10.1016/j.tins.2014.08.005>.
- Lara-Vasquez, A., Espinosa, N., Durán, E., Stockle, M., Fuentealba, P., 2016. Midline thalamic neurons are differentially engaged during hippocampus network oscillations. *Sci. Rep.* 6, 29807. <https://doi.org/10.1038/srep29807>.
- Layfield, D.M., Patel, M., Hallock, H., Griffin, A.L., 2015. Inactivation of the nucleus reuniens/rhomboid causes a delay-dependent impairment of spatial working memory. *Neurobiol. Learn. Mem.* 125, 163–167. <https://doi.org/10.1016/j.nlm.2015.09.007>.
- Lee, J.L.C., Nader, K., Schiller, D., 2017. An update on memory reconsolidation updating. *Trends Cogn. Sci. (Regul. Ed.)* 21 (7), 531–545. <https://doi.org/10.1016/j.tics.2017.04.006>.
- Lesburgueres, E., Gobbo, O.L., Alaux-Cantin, S., Hambucken, A., Trifilieff, P., Bontempi, B., 2011. Early tagging of cortical networks is required for the formation of enduring associative memory. *Science* 331 (6019), 924–928. <https://doi.org/10.1126/science.1196164>.
- Li, Y., Lopez-Huerta, V.G., Adiconis, X., Levandowski, K., Choi, S., et al., 2020. Distinct subnetworks of the thalamic reticular nucleus. *Nature* 583 (7818), 819–824. <https://doi.org/10.1038/s41586-020-2504-5>.
- Lin, Y.-J., Chiou, R.-J., Chang, C.-H., 2020. The reuniens and rhomboid nuclei are required for acquisition of pavlovian trace fear conditioning in rats. *eNeuro* 7 (3). <https://doi.org/10.1523/ENEURO.0106-20.2020>. ENEURO.0106-20.2020.
- Linley, S.B., Gallo, M.M., Vertes, R.P., 2016. Lesions of the ventral midline thalamus produce deficits in reversal learning and attention on an odor texture set shifting task. *Brain Res.* 1649 (Pt A), 110–122. <https://doi.org/10.1016/j.brainres.2016.08.022>.
- Lorente de No, R., 1938. Cerebral cortex: architecture, intracortical connections, motor projections. In: Fulton, J. (Ed.), *Physiology of the Nervous System*. Oxford University Press, London, pp. 291–340.
- Loureiro, M., Cholvin, T., Lopez, J., Merienne, N., Latreche, A., Cosquer, B., Geiger, K., Kelche, C., Cassel, J.C., Pereira de Vasconcelos, A., 2012. The ventral midline thalamus (reuniens and rhomboid nuclei) contributes to the persistence of spatial memory in rats. *J. Neurosci.* 32, 9947–9959. <https://doi.org/10.1523/JNEUROSCI.0410-12.2012>.
- Mably, A.J., Liu, W., Mc Donald, J.M., Dodart, J.C., Bard, F., Lemere, C.A., O'Nuallain, B., Walsh, D.M., 2015. Anti-A β antibodies incapable of reducing cerebral A β oligomers fail to attenuate spatial reference memory deficits in J20 mice. *Neurobiol. Dis.* 82, 372–384. <https://doi.org/10.1016/j.nbd.2015.07.008>.
- Maissen, D.J.-N., Gemzik, Z.M., Griffin, A.L., 2018. Optogenetic suppression of the nucleus reuniens selectively impairs encoding during spatial working memory. *Neurobiol. Learn. Mem.* 155, 78–85. <https://doi.org/10.1016/j.nlm.2018.06.010>.
- Marek, R., Sun, Y., Sah, P., 2019. Neural circuits for a top-down control of fear and extinction. *Psychopharmacology (Berl.)* 236 (1), 313–320. <https://doi.org/10.1007/s00213-018-5033-2>.
- Maren, S., 2011. Seeking a spotless mind: extinction, deconsolidation, and erasure of fear memory. *Neuron* 70 (5), 830–845. <https://doi.org/10.1016/j.neuron.2011.04.023>.
- Mathiasen, M.L., Amin, E., Nelson, A.J.D., Dillingham, C.M., O'Mara, S.M., Aggleton, J.P., 2019. Separate cortical and hippocampal cell populations target the rat nucleus reuniens and mammillary bodies. *Eur. J. Neurosci.* 49 (12), 1649–1672. <https://doi.org/10.1111/ejn.14341>.
- Mathiasen, M.L., O'Mara, S.M., Aggleton, J.P., 2020. The anterior thalamic nuclei and nucleus reuniens: so similar but so different. *Neurosci. Biobehav. Rev.* 119, 268–280. <https://doi.org/10.1016/j.neubiorev.2020.10.006>.
- McKenna, J.T., Vertes, R.P., 2004. Afferent projections to nucleus reuniens of the thalamus. *J. Comp. Neurol.* 480 (2), 115–142. <https://doi.org/10.1002/cne.20342>.
- Morales, G.J., Ramcharan, E.J., Sundararaman, N., Morgera, S.D., Vertes, R.P., 2007. Analysis of the actions of reuniens nucleus and the entorhinal cortex on EEG and evoked population behaviour of the hippocampus. *Conf. Proc. IEEE Eng. Med. Biol. Soc.* 2007, 2480–2484. <https://doi.org/10.1109/IEMBS.2007.4352831>.
- Morison, R.S., Dempsey, E.W., 1942. A study of thalamo-cortical relations. *Am. J. Physiol.* 135, 281–292.
- Moruzzi, G., Magoun, H.W., 1949. Brain stem reticular formation and activation of the EEG. *Electroencephalogr. Clin. Neurophysiol.* 1, 455–473.
- Moscarello, J.M., 2020. Prefrontal cortex projections to the nucleus reuniens suppress freezing following two-way signaled avoidance training. *Learn. Mem.* 27 (3), 119–123. <https://doi.org/10.1101/lm.050377.119>.
- Moscarello, J.M., Maren, S., 2018. Flexibility in the face of fear: hippocampal-prefrontal regulation of fear and avoidance. *Curr. Opin. Behav. Sci.* 19, 44–49. <https://doi.org/10.1016/j.cobeha.2017.09.010>.
- Muir, J.L., 1996. Attention and stimulus processing in the rat. *Brain Res. Cogn. Brain Res.* 3 (3–4), 215–225. [https://doi.org/10.1016/0926-6410\(96\)00008-0](https://doi.org/10.1016/0926-6410(96)00008-0).
- Nagalski, A., Puelles, L., Dabrowski, M., Wegierski, T., Kuznicki, J., Wisniewska, M.B., 2016. Molecular anatomy of the thalamic complex and the underlying transcription factors. *Brain Struct. Funct.* 221 (5), 2493–2510. <https://doi.org/10.1007/s00429-015-1052-5>.
- Nelson, A.J.D., Olarte-Sanchez, C.M., Eman Amin, E., John, P., Aggleton, J.P., 2016. Perirhinal cortex lesions that impair object recognition memory spare landmark discriminations. *Behav. Brain Res.* 313, 255–259. <https://doi.org/10.1016/j.bbr.2016.07.031>.
- Ogundele, O.M., Lee, C.C., Francis, J., 2017. Thalamic dopaminergic neurons project to the paraventricular nucleus-rostral ventrolateral medulla/C1 neural circuit. *Anat. Rec. Hoboken (Hoboken)* 300 (7), 1307–1314. <https://doi.org/10.1002/ar.23528>.
- Olarte-Sanchez, C.M., Amin, E., Warburton, E.C., Aggleton, J.P., 2015. Perirhinal cortex lesions impair tests of object recognition memory but spare novelty detection. *Eur. J. Neurosci.* 42 (12), 3117–3127. <https://doi.org/10.1111/ejn.13106>.
- Parent, M.A., Wang, L., Su, J., Netoff, T., Yuan, L.L., 2010. Identification of the hippocampal input to medial prefrontal cortex in vitro. *Cereb. Cortex* 20 (2), 393–403. <https://doi.org/10.1093/cercor/bhp108>.
- Patton, M.H., Bizup, B.T., Grace, A.A., 2013. The infralimbic cortex bidirectionally modulates mesolimbic dopamine neuron activity via distinct neural pathways. *J. Neurosci.* 33 (43), 16865–16873. <https://doi.org/10.1523/JNEUROSCI.2449-13.2013>.
- Pedraza, L.K., Sierra, R.O., Giachero, M., Nunes-Souza, W., Lotz, F.N., de Oliveira Alvares, L., 2019. Chronic fluoxetine prevents fear memory generalization and enhances subsequent extinction by remodeling hippocampal dendritic spines and slowing down systems consolidation. *Transl. Psychiatry* 9 (1), 53. <https://doi.org/10.1038/s41398-019-0371-3>.
- Pereira de Vasconcelos, A., Cassel, J.C., 2015. The non-specific thalamus: a place in a wedding bed for making memories last. *Neurosci. Biobehav. Rev.* 54, 175–196. <https://doi.org/10.1016/j.neubiorev.2014.10.021>.

- Pezze, M.A., Marshall, H.J., Fone, K.C., Cassaday, H.J., 2015. Dopamine D1 receptor stimulation modulates the formation and retrieval of novel object recognition memory: role of the prelimbic cortex. *Eur. Neuropsychopharmacol.* 25 (11), 2145–2156. <https://doi.org/10.1016/j.euroneuro.2015.07.018>.
- Prasad, J.A., Macgregor, E.M., Chudasama, Y., 2013. Lesions of the thalamic reuniens cause impulsive but not compulsive responses. *Brain Struct. Funct.* 218 (1), 85–96. <https://doi.org/10.1007/s00429-012-0378-5>.
- Prasad, J.A., Abela, A.R., Chudasama, Y., 2017. Midline thalamic reuniens lesions improve executive behaviors. *Neuroscience* 345, 77–88. <https://doi.org/10.1016/j.neuroscience.2016.01.071>.
- Qi, C.C., Wang, Q.J., Ma, X.Z., Chen, H.C., Gao, L.P., Yin, J., Jing, Y.H., 2018. Interaction of basolateral amygdala, ventral hippocampus and medial prefrontal cortex regulates the consolidation and extinction of social fear. *Behav. Brain Funct.* 14 (1), 7. <https://doi.org/10.1186/s12993-018-0139-6>.
- Quef, E., Majchrzak, M., Cosquer, B., Marvan, T., Wolff, M., Cassel, J.C., Pereira de Vasconcelos, A., Stephan, A., 2020a. The reuniens and rhomboid nuclei are necessary for contextual fear memory persistence in rats. *Brain Struct. Funct.* 225 (3), 955–968. <https://doi.org/10.1007/s00429-020-02048-z>.
- Quef, E., Cassel, J.C., Cosquer, B., Galloux, M., Pereira de Vasconcelos, A., Stéphan, A., 2020b. Ventral midline thalamus is not necessary for systemic consolidation of a social memory in the rat. *Brain Neurosci. Adv.* 4 (1–9), 973. <https://doi.org/10.1177/2398212820939738.8>.
- Ragozzino, M.E., Detrick, S., Kesner, R.P., 2002. The effects of prelimbic and infralimbic lesions on working memory for visual objects in rats. *Neurobiol. Learn. Mem.* 77 (1), 29–43. <https://doi.org/10.1006/nlme.2001.4003>.
- Ramanathan, K.R., Maren, S., 2019. Nucleus reuniens mediates the extinction of contextual fear conditioning. *Behav. Brain Res.* 374, 112114. <https://doi.org/10.1016/j.bbr.2019.112114>.
- Ramanathan, K.R., Ressler, R.L., Jin, J., Maren, S., 2018a. Nucleus reuniens is required for encoding and retrieving precise, hippocampal-dependent contextual fear memories in rats. *J. Neurosci.* 38 (46), 9925–9933. <https://doi.org/10.1523/JNEUROSCI.1429-18.2018>.
- Ramanathan, K.R., Jin, J., Giustino, T.F., Payne, M.R., Maren, S., 2018b. Prefrontal projections to the thalamic nucleus reuniens mediate fear extinction. *Nat. Commun.* 9 (1), 4527. <https://doi.org/10.1038/s41467-018-06970-z>.
- Roy, A., Petterson Svensson, F., Mazeh, A., Kocsis, B., 2017. Prefrontal-hippocampal coupling by theta rhythm and by 2–5 Hz oscillation in the delta band: the role of the nucleus reuniens of the thalamus. *Brain Struct. Funct.* 222 (6), 2819–2830. <https://doi.org/10.1007/s00429-017-1374-6>.
- Russo, S.J., Nestler, E.J., 2013. The brain reward circuitry in mood disorders. *Nat. Rev. Neurosci.* 14 (9), 609–625. <https://doi.org/10.1038/nrn3381>.
- Salay, L.D., Ishiko, N., Huberman, A.D., 2018. A midline thalamic circuit determines reactions to visual threat. *Nature* 557 (7704), 183–189. <https://doi.org/10.1038/s41586-018-0078-2>.
- Santini, L.J., Rubio, S., Begega, A., Arias, J.L., 1999. Non-effects of mammillary body lesions on spontaneous alternation: pre and postoperative study. *Behav. Processes* 44 (3), 323–329. [https://doi.org/10.1016/s0376-6357\(98\)00055-2](https://doi.org/10.1016/s0376-6357(98)00055-2).
- Savage, L.M., Nunes, P.T., Gursky, Z.H., Katrina, A., Milbocker, K.A., Anna, Y., Klintsova, A.Y., 2020. Midline thalamic damage associated with alcohol-use disorders: disruption of distinct thalamocortical pathways and function. *Neuropsychol. Rev.* <https://doi.org/10.1007/s11065-020-09450-8>. Aug 12.
- Schall, K.P., Kerber, J., Dickson, C.T., 2008. Rhythmic constraints on hippocampal processing: state and phase-related fluctuations of synaptic excitability during theta and the slow oscillation. *J. Neurophysiol.* 99 (2), 888–899. <https://doi.org/10.1152/jn.00915.2007>.
- Scheel, N., Wulff, P., de Mooij-van Malsen, J.G., 2020. Afferent connections of the thalamic nucleus reuniens in the mouse. *J. Comp. Neurol.* 528 (7), 1189–1202. <https://doi.org/10.1002/cne.24811>.
- Sierra, R.O., Pedraza, L.K., Zanona, Q.K., Santana, F., Boos, F.Z., Crestani, A.P., Haubrich, J., de Oliveira Alvares, L., Calcagnotto, M.E., Quilfeldt, J.A., 2017. Reconsolidation-induced rescue of a remote fear memory blocked by an early cortical inhibition: involvement of the anterior cingulate cortex and the mediation by the thalamic nucleus reuniens. *Hippocampus* 27 (5), 596–607. <https://doi.org/10.1002/hipo.22715>.
- Silva, B.A., Burns, A.M., Graff, J., 2018. A cFos activation map of remote fear memory "attenuation". *Psychopharmacology (Berl.)* 236 (1), 369–381. <https://doi.org/10.1007/s00213-018-5000-y>.
- Squire, L.R., Genzel, L., Wixted, J.T., Morris, R.G., 2015. Memory consolidation. *Cold Spring Harb. Perspect. Biol.* 7 (8), a021766. <https://doi.org/10.1101/cshperspect.a021766>.
- Swanson, L.W., 1981. A direct projection from Ammon's horn to prefrontal cortex in the rat. *Brain Res.* 217 (1), 150–154. [https://doi.org/10.1016/0006-8993\(81\)90192-x](https://doi.org/10.1016/0006-8993(81)90192-x).
- Sziklas, V., Petrides, M., 1998. Memory and the region of the mammillary bodies. *Prog. Neurobiol.* 54 (1), 55–70. [https://doi.org/10.1016/s0301-0082\(97\)00064-6](https://doi.org/10.1016/s0301-0082(97)00064-6).
- Takagishi, M., Chiba, T., 1991. Efferent projections of the infralimbic (area 25) region of the medial prefrontal cortex in the rat: an anterograde tracer PHA-L study. *Brain Res.* 566 (1–2), 26–39. [https://doi.org/10.1016/0006-8993\(91\)91677-s](https://doi.org/10.1016/0006-8993(91)91677-s).
- Tan, H.M., Wills, T.J., Cacucci, F., 2017. The development of spatial and memory circuits in the rat. *Wiley Interdiscip. Rev. Cogn. Sci.* 8 (3) <https://doi.org/10.1002/wcs.1424>.
- Taube, J.S., 2007. The head direction signal: origins and sensory-motor integration. *Annu. Rev. Neurosci.* 30, 181–207. <https://doi.org/10.1146/annurev.neuro.29.051605.112854>.
- Thierry, A.M., Gioanni, Y., Degenetis, E., Glowinski, J., 2000. Hippocampo-prefrontal cortex pathway: anatomical and electrophysiological characteristics. *Hippocampus* 10 (4), 411–419. [https://doi.org/10.1002/1098-1063\(2000\)10:4<411::AID-IPO7>3.0.CO;2-A](https://doi.org/10.1002/1098-1063(2000)10:4<411::AID-IPO7>3.0.CO;2-A).
- Tomasella, E., Bechelli, L., Ogando, M.B., Mininni, C., Di Guilmi, M.N., De Fino, F., Zanutto, S., Elgoyhen, A.B., Marin-Burgin, A., Gelman, D.M., 2018. Deletion of dopamine D2 receptors from parvalbumin interneurons in mouse causes schizophrenia-like phenotypes. *Proc. Natl. Acad. Sci. U.S.A.* 115 (13), 3476–3481. <https://doi.org/10.1073/pnas.1719897115>.
- Tomasella, E., Falasco, G., Urrutia, L., Bechelli, L., Padilla, L., Gelman, D.M., 2020. Impaired brain glucose metabolism and presynaptic dopaminergic functioning in a mouse model of schizophrenia. *EJNMMI Res.* 10 (1), 39. <https://doi.org/10.1186/s13550-020-00629-x>.
- Troyner, F., Bicca, M.A., Bertoglio, L.J., 2018. Nucleus reuniens of the thalamus controls fear memory intensity, specificity and long-term maintenance during consolidation. *Hippocampus* 28 (8), 602–616. <https://doi.org/10.1002/hipo.22964>.
- Van Der Werf, Y.D., Witter, M.P., Groenenwegen, H.J., 2002. The intralaminar and midline nuclei of the thalamus. Anatomical and functional evidence for participation in processes of arousal and awareness. *Brain Res. Rev.* 39, 107–140. [https://doi.org/10.1016/s0165-0173\(02\)00181-9](https://doi.org/10.1016/s0165-0173(02)00181-9).
- Vann, S.D., Nelson, A.J., 2015. The mammillary bodies and memory: more than a hippocampal relay. *Prog. Brain Res.* 219, 163–185. <https://doi.org/10.1016/bs.pbr.2015.03.006>.
- Varela, C., Kumar, S., Yang, J.Y., Wilson, M.A., 2014. Anatomical substrates for direct interactions between hippocampus, medial prefrontal cortex, and the thalamic nucleus reuniens. *Brain Struct. Funct.* 219, 911–929. <https://doi.org/10.1007/s00429-013-0543-5>.
- Vertes, R.P., 2002. Analysis of projections from the medial prefrontal cortex to the thalamus in the rat, with emphasis on nucleus reuniens. *J. Comp. Neurol.* 442 (2), 163–187. <https://doi.org/10.1002/cne.10083>.
- Vertes, R.P., 2004. Differential projections of the infralimbic and prelimbic cortex in the rat. *Synapse* 51, 32–58. <https://doi.org/10.1002/syn.10279>.
- Vertes, R.P., Hoover, W.B., Do Valle, A.C., Sherman, A., Rodriguez, J.J., 2006. Efferent projections of reuniens and rhomboid nuclei of the thalamus in the Rat. *J. Comp. Neurol.* 499, 768–796. <https://doi.org/10.1002/cne.21135>.
- Vertes, R.P., Hoover, W.B., Szigeti-Buck, K., Leranath, C., 2007. Nucleus reuniens of the midline thalamus: link between the medial prefrontal cortex and the hippocampus. *Brain Res. Bull.* 71 (6), 601–609. <https://doi.org/10.1016/j.brainresbull.2006.12.002>.
- Vertes, R.P., Linley, S.B., Hoover, W.B., 2010. Pattern of distribution of serotonergic fibers to the thalamus of the rat. *Brain Struct. Funct.* 215 (1), 1–28. <https://doi.org/10.1007/s00429-010-0249-x>.
- Vertes, R.P., Linley, S.B., Hoover, W.B., 2015. Limbic circuitry of the midline thalamus. *Neurosci. Biobehav. Rev.* 54, 89–107. <https://doi.org/10.1016/j.neubiorev.2015.01.014>.
- Viana Di Prisco, G., Vertes, R.P., 2006. Excitatory actions of the ventral midline thalamus (Rhomboid/reuniens) on the medial prefrontal cortex in the rat. *Synapse* 60, 45–55. <https://doi.org/10.1002/syn.20271>.
- Viana, T.D., Linley, S.B., Vertes, R.P., 2018. Inactivation of nucleus reuniens impairs spatial working memory and behavioral flexibility in the rat. *Hippocampus* 28 (4), 297–311. <https://doi.org/10.1002/hipo.22831>.
- Viana, T.D., Rasch, G.E., Silva, D., Allen, T.A., 2020. Calretinin and calbindin architecture of the midline thalamus associated with prefrontal-hippocampal circuitry. *Hippocampus* 2020. <https://doi.org/10.1002/hipo.23271>. Oct 21.
- Vu, T., Gugustea, R., Leung, L.S., 2020. Long-term potentiation of the nucleus reuniens and entorhinal cortex to CA1 distal dendritic synapses in mice. *Brain Struct. Funct.* 225 (6), 1817–1838. <https://doi.org/10.1007/s00429-020-02095-6>.
- Walsh, D.A., Brown, J.T., Randall, A.D., 2017. In vitro characterization of cell-level neurophysiological diversity in the rostral nucleus reuniens of adult mice. *J. Physiol. (Paris)* 595 (11), 3549–3572. <https://doi.org/10.1113/JP273915>.
- Walsh, D.A., Brown, J.T., Randall, A.D., 2020. Neurophysiological alterations in the nucleus reuniens of a mouse model of Alzheimer's disease. *Neurobiol. Aging* 88, 1–10. <https://doi.org/10.1016/j.neurobiolaging.2019.12.006>.
- Webster, S.J., Bachstetter, A.D., Nelson, P.T., Schmitt, F.A., Van Eldik, L.J., 2014. Using mice to model Alzheimer's dementia: an overview of the clinical disease and the preclinical behavioral changes in 10 mouse models. *Front. Genet.* 5, 88. <https://doi.org/10.3389/fgene.2014.00088>.
- Whitesell, J.D., Buckley, A.R., Knox, J.E., Kuan, L., Graddis, N., Pelos, A., Mukora, A., Wakeman, W., Bohn, P., Ho, A., Hirokawa, K.E., Harris, J.A., 2019. Whole brain imaging reveals distinct spatial patterns of amyloid beta deposition in three mouse models of Alzheimer's disease. *J. Comp. Neurol.* 527 (13), 2122–2145. <https://doi.org/10.1002/cne.24555>.

- Wolff, M., Alcaraz, F., Marchand, A.R., Coutureau, E., 2015. Functional heterogeneity of the limbic thalamus: from hippocampal to cortical functions. *Neurosci. Biobehav. Rev.* 54, 120–130.
<https://doi.org/10.1016/j.neubiorev.2014.11.011>.
- Xu, W., Südhof, T.C., 2013. A neural circuit for memory specificity and generalization. *Science* 339, 1290–1295.
<https://doi.org/10.1126/science.1229534>.
- Zimmerman, E.C., Grace, A.A., 2016. The nucleus reuniens of the midline thalamus gates prefrontal-hippocampal modulation of ventral tegmental area dopamine neuron activity. *J. Neurosci.* 36 (34), 8977–8984.
<https://doi.org/10.1523/JNEUROSCI.1402-16.2016>.