



**HAL**  
open science

## Extending the Balbi fire spread Model for field scale conditions: the case of shrubland fires

François Joseph Chatelon, Jacques Henri Balbi, Miguel Cruz, Dominique Morvan, Jean Louis Rossi, Carmen Awad, Nicolas Frangieh, Jacky Fayad, Thierry Marcelli

### ► To cite this version:

François Joseph Chatelon, Jacques Henri Balbi, Miguel Cruz, Dominique Morvan, Jean Louis Rossi, et al.. Extending the Balbi fire spread Model for field scale conditions: the case of shrubland fires. International Journal of Wildland Fire, 2022, 31 (2), pp.176-192. 10.1071/WF21082 . hal-04064057

**HAL Id: hal-04064057**

**<https://amu.hal.science/hal-04064057v1>**

Submitted on 10 Apr 2023

**HAL** is a multi-disciplinary open access archive for the deposit and dissemination of scientific research documents, whether they are published or not. The documents may come from teaching and research institutions in France or abroad, or from public or private research centers.

L'archive ouverte pluridisciplinaire **HAL**, est destinée au dépôt et à la diffusion de documents scientifiques de niveau recherche, publiés ou non, émanant des établissements d'enseignement et de recherche français ou étrangers, des laboratoires publics ou privés.

1     **Extending the Balbi fire spread Model for field scale conditions:**  
2                                   **the case of shrubland fires**

3

4     **François Joseph CHATELON<sup>1</sup>, Jacques Henri BALBI<sup>1</sup>, Miguel G. CRUZ<sup>2</sup>, Dominique**  
5 **MORVAN<sup>3</sup>, Jean Louis ROSSI<sup>1</sup>, Carmen AWAD<sup>1</sup>, Nicolas FRANGIEH<sup>1</sup>, Jacky FAYAD<sup>1</sup>**  
6                                   **and Thierry MARCELLI<sup>1,\*</sup>**

7     <sup>1</sup>Université de Corse, Systèmes Pour l'Environnement UMR-CNRS 6134, Campus Grimaldi,  
8                                   BP 52 20250 Corte, France.

9                                   <sup>2</sup>CSIRO, GPO Box 1700, Canberra, ACT 2601, Australia.

10                                  <sup>3</sup>Aix Marseille Univ, CNRS, Centrale Marseille, M2P2, Marseille, France.

11

12     **Abstract:** The ‘Balbi model’ is a simplified rate of fire spread model aimed at providing fast  
13 and accurate simulations for fire spread that can be used by fire managers under operational  
14 conditions. This model describes the steady-state spread rate of surface fires by accounting for  
15 both radiation and convection heat transfer processes. In the present work the original Balbi  
16 model developed for laboratory conditions is improved with changes that address specificities  
17 of outdoor fires, such as fuel complexes with a mix of live and dead materials, a larger scale  
18 and an open environment. The model is calibrated against a small training dataset (n=25) of  
19 shrubland fires conducted in Turkey. A sensitivity analysis of model output is presented and its  
20 predictive capacity against a larger independent dataset of experimental fires in shrubland fuels

---

\* Corresponding Author. Email: marcelli\_t@univ-corse.fr

21 from different regions of the world (Europe, Australia, New-Zealand and South Africa) is  
22 tested. A comparison with older versions of the model and a generic-empirical model is also  
23 conducted to investigate contrasts with other models and quantify improvements in the  
24 predictive capacity of the model. The improved model remains physics-based, faster than real  
25 time and fully predictive.

26

27

28 **Keywords:** Fire spread, shrubs, live fuel, radiation, convection, fire dynamics, model  
29 performance, physical model, steady-state model

30

31

## 32 **Introduction**

33 Many regions of the world are severely hit by severe wildfires. As the result of interactions  
34 between climate, fuels, topography and people, wildfires can have negative socioeconomic and  
35 ecological consequences (Finlay *et al.* 2012; Meyer *et al.* 2013; Youssouf *et al.* 2014; Castro  
36 Rego *et al.* 2018; Dupuy *et al.* 2020; European Science & Technology Advisory Group 2020).  
37 They represent a significant factor changing ecosystem function and resilience (Wotton *et al.*  
38 2003; Running 2006; Sağlam *et al.* 2008; Fernandes 2013; San-Miguel-Ayanz *et al.* 2013; Tang  
39 *et al.* 2015) and they pose a threat to human life, infrastructure and activities, particularly when  
40 fires spread into the Wildland-Urban Interface (Radeloff *et al.* 2005; Hammer *et al.* 2007;  
41 Keane *et al.* 2010). These negative impacts of wildfires have been exacerbated as a result of  
42 climate change (European Science & Technology Advisory Group 2020). The need for fire  
43 spread simulation tools (e.g. Finney (1998); Filippi *et al.* (2011); Mandel *et al.* (2011)) that aid  
44 emergency response, firefighting and fire management decision making has become more and  
45 more crucial. Development of new fire spread models that overcome previous ones constraints  
46 and limitations is one of the main aims of fire behaviour scientists around the globe.

47 Over the last three decades, significant advances made on physical and chemical modelling of  
48 wildland fire processes has contributed to the development of a significant number of models  
49 describing wildfire propagation. This model evolution reviewed by several authors (Weber  
50 1991; Perry 1998; Pastor *et al.* 2003; Sullivan 2009a; b; c) is basically categorized in three main  
51 approaches: (1) mathematical or empirical models, (2) semi-empirical models and (3) physical  
52 models.

53 Statistical or empirical models (McArthur 1966; Noble *et al.* 1980; Cheney *et al.* 1998;  
54 Anderson *et al.* 2015; Rossa and Fernandes 2018) are generally built over a large set of  
55 observational data and they do not describe any physical mechanisms for heat transfer. The fire  
56 rate of spread is usually defined as a function of several independent variables such as wind

57 velocity, terrain slope angle, fuel moisture content and fuel structure variables (Cheney *et al.*  
58 1998; Fernandes 2001; Keane 2019a). Semi-empirical models, such as the well-known  
59 Rothermel model (Rothermel 1972), are able to simplify the physical description of the fire  
60 spread processes while incorporating some key principles. Both the empirical and semi-  
61 empirical approach produced models that are applicable to operational conditions. For example,  
62 the Rothermel (1972) is at the core of fire behaviour prediction systems like BEHAVE  
63 (Andrews 1986) and FARSITE (Finney 1998). It is also incorporated in more comprehensive  
64 fire - weather prediction systems like WRF-SFIRE (Mandel *et al.* 2011; Kochanski *et al.* 2013).

65 In contrast, physical models are based on the understanding of physical and chemical processes  
66 determining wildland fire behaviour. These models describe how the heat, mass and momentum  
67 fluxes are transferred from the fuel burning zone or from the flame body to the unburnt fuel  
68 (Lattimer 2019). Detailed physical models based on multiphase modelling (Grishin 1997;  
69 Morvan *et al.* 2000) solve a system of partial differential equations strongly coupled obtained  
70 from the gaseous phase and the different solid phases and represent the physical basis of  
71 computational fluid dynamics (CFD) simulators such as FireStar2D (Morvan *et al.* 2009),  
72 FireStar3D (Frangieh *et al.* 2018; Morvan *et al.* 2018), FIRETEC (Linn and Cunningham 2005)  
73 or Wildland Urban Interface Fire Dynamics Simulator, WFDS (Mell *et al.* 2007). These CFD-  
74 models are of great interest to extend our understanding of the physics of the fire dynamics but  
75 they are not suitable for simulating fire spread at large scales and under time constraints because  
76 of the high computational requirements.

77 Simplified physical models (Pagni and Peterson 1973; Albini 1985, 1986; Koo *et al.* 2005;  
78 Balbi *et al.* 2007) are a family of models that can bridge the gap between the simple empirical  
79 models and complex physical models. They incorporate the most important physical processes  
80 without having the computational needs of a full physical model, allowing for their use in  
81 operational settings. These models require parameterization of certain intermediate processes,

82 but this parameterization can be done with only a few fires in contrast with the data needs for  
83 the development of empirical models. This is significant due to the costs and inherent  
84 limitations of conducting large scale, high intensity experimental fire programs.

85 The ‘Balbi model’ (Balbi *et al.* 2020) follows this concept. The model is a fully predictive  
86 simplified physical model for surface fire spread which takes into account meteorological (wind  
87 velocity), topographical (terrain slope angle) and fuel (fuel moisture and fuel bed structure)  
88 conditions. The model has been developed and parameterized to describe fire propagation in  
89 free spreading fires at a laboratory scale (e.g. Nelson Jr. and Adkins (1986); Catchpole *et al.*  
90 (1998)).

91 The main goal of this paper is to extend the previous work by introducing changes that allow  
92 its use in outdoor fires, where scale and fuel characteristics depart from the original model  
93 fitting. The parameterization is applied to shrubland fuel types, an interesting challenge for the  
94 proposed model due to the stratified fuel complex arrangement composed of vertically  
95 separated fuel layers (Cruz *et al.* 2013). The new formulation is evaluated through the analysis  
96 of the effect of environmental variables in the model output and against a large set of outdoor  
97 shrubland fires given in (Anderson *et al.* 2015). A comparison between the obtained model fit  
98 statistics with results from other models is also made.

## 99 **Methods**

### 100 *Model idealization*

#### 101 *The Balbi et al. (2020) model*

102 The global structure of the model proposed by Balbi *et al.* (2020) is kept, with changes  
103 introduced that aim at simulate relevant processes occurring in shrubland fires. Following  
104 Chatelon *et al.* (2017) and Balbi *et al.* (2020), it is still assumed that the fresh airstream which

105 enters the flame base (the pyrolysis area) is divided in two layers (Fig. 1): the hot gases from  
106 the upper layer are driven to the top of the flame base, due to buoyancy and create the free  
107 flame structure above the vegetal stratum. The mixed air-pyrolysis gases from the lower layer  
108 go out through the front panel of the fuel burning particles area and create an internal, or  
109 combustion zone, flame which directly contacts the unburnt fuel.

110 The four energy contributions suggested by Balbi *et al.* (2020) are considered: (1) flame base  
111 radiation (the fuel burning particles radiate towards the unburnt fuel); (2) flame radiation (the  
112 flame body acts as a grey radiant panel); (3) convective cooling (the flame body creates a  
113 indraught of fresh air coming from the unburnt zone which offsets the flame radiation and the  
114 periodic free flame contact with unburnt fuels because of turbulent effects); and (4) convective  
115 heating (hot gases flow from the combustion zone and impinge the unburnt fuel particles by  
116 direct contact). Note that the convective cooling effect did not explicitly appear in the equation  
117 of the model but is incorporated in the flame radiation modelling (Balbi *et al.* 2010).

118 The rate of spread was obtained using a simplified preheating balance and based on the fuel  
119 load  $\sigma$  and fuel moisture content  $m$  of the dead fuel. The main equation of the model, in a  
120 condensed form, is the following:

$$121 \quad R = R_b + R_c + R_r \quad (1)$$

122 With

$$123 \quad R_b = a_{b\sigma} \frac{\phi_b}{q} \quad (2)$$

$$124 \quad R_c = a_{c\sigma} \frac{\phi_c}{q} \quad (3)$$

$$125 \quad R_r = a_{r\sigma} \frac{\phi_r}{q} \quad (4)$$

126 where  $R_{\bullet}$ ,  $\phi_{\bullet}$ ,  $a_{\bullet}$ , are the contributions of heat transfer mechanisms to the ROS, heat fluxes and  
127 scaling factors, respectively. The term  $q$  represents the energy required for ignition:

$$128 \quad q = C_p(T_i - T_a) + m(\Delta h + C_{pw}(T_{vap} - T_a)) \quad (5)$$

129 where  $C_p$ ,  $C_{pw}$ ,  $T_i$ ,  $T_a$ ,  $T_{vap}$ ,  $\Delta h$ ,  $m$  are specific heat of fuel and water, ignition, ambient and  
130 vaporization temperature, heat of latent evaporation and fuel moisture content respectively (see  
131 Table 1).

### 132 *Changes in the scaling factors*

133 The scaling factors in Eqns 2-4 are modified in order to take into account the live fuel. As the  
134 flame base scaling factor  $a_b$  increases with the fuel height and decreases with the extinction  
135 depth  $\delta$ , it was defined in (Balbi *et al.* 2020) by the following relationship:

$$136 \quad a_b = \min\left(2\frac{h}{\delta}, 1\right) \quad (6)$$

137 Two slight changes are made on Eqn 6. First, the factor 2 in Eqn 6 is removed because it is  
138 assumed that at field scale the soil absorbs a part of the flame base radiative flux unlike the  
139 laboratory experiments in which the ground reflects the flame base radiation. Second, following  
140 the work of De Mestre *et al.* (1989) about optical depth, Balbi *et al.* (2020) have defined the  
141 extinction depth as inversely proportional to the fuel porosity ( $\delta = 2\pi/(s\beta_t)$ ), where  $s$  is the  
142 surface area to volume ratio and  $\beta_t$  is the total packing ratio (dead and live fuel load). So,  
143 considering the total leaf area  $S_t$  (equal to the double of total LAI (Keane 2019b)), the scaling  
144 factor  $a_b$  is changed in:

$$145 \quad a_b = \min\left(\frac{S_t}{2\pi}, 1\right) \quad (7)$$



146 Moreover, as one part of the heat release affects the live fuel and assuming that the spread of  
 147 the ignition interface mainly depends on the catalytic effect of dead fuel, the leaf areas ratio  
 148 (dead and total) is added to the scaling factor  $a_b$ :

$$149 \quad a_b = \min\left(\frac{S_t}{2\pi'}1\right)\left(\frac{S}{S_t}\right)^2 \quad (8)$$

150 The square on the ratio  $S/S_t$  expresses the action of this ‘energy sink’ effect on both emitted and  
 151 absorbed flame base radiation, where  $S$  is the leaf area ( $2 \times \text{LAI}$ ). As noticed by Chandler *et al.*  
 152 (1983), it seems that live fuel properties have a role on fire behaviour but this role is not clear  
 153 (Pimont *et al.* 2019) and still discussed in the literature. Inhere, it is assumed that the live fuel  
 154 is not directly involved in movement of the ignition interface, but as it contributes a proportion  
 155 of the heat released, the part of the heat which does not impinge the dead fuel material is added  
 156 in the improved model as the ratio between dead leaf area and total leaf area (which is related  
 157 to a ratio between dead and total packing ratio).

158 The scaling factor  $a_r$  related to the flame radiation heat flux is similarly modified but only the  
 159 absorption of this heat flux by the unburnt fuel is concerned:

$$160 \quad a_r = \min\left(\frac{h}{\delta'}1\right)\frac{S}{S_t} = \min\left(\frac{S_t}{2\pi'}1\right)\frac{S}{S_t} = \min\left(\frac{S}{2\pi'S_t}\right) \quad (9)$$

161 The scaling factor  $a_c$  related to the convective heat flux is significantly changed. It is now split  
 162 up in three contributions which corresponds to energy losses:

$$163 \quad a_c = a_{up} a_{lat} a_{liv} \quad (10)$$

164 The factor  $a_{liv}$  represents the heat provided to the unburnt live fuel and the same modelling as  
 165 in the scaling factors  $a_b$  and  $a_r$  is chosen:

$$166 \quad a_{liv} = \frac{S}{S_t} \quad (11)$$

167 The factor  $a_{lat}$  describes the heat loss on the lateral edges of the fire front. Balbi *et al.* (2020)  
 168 assumed this factor was equal to 1 for a laboratory set up where lateral walls constrained lateral  
 169 heat losses at the combustion zone level (Catchpole *et al.* 1998). In our present formulation it  
 170 is assumed that this factor explicitly depends on the effective fireline width  $W_0$  (Cheney and  
 171 Gould 1995) but remains equal to 1 when  $W_0$  is greater than 50 m. For the current analysis  $W_0$   
 172 is represented by the ignition line length in (Anderson *et al.* 2015).  $W_0$  in the dataset change  
 173 with experimental source/fuel type. See appendix B for further discussion):

$$174 \quad a_{lat} = \min\left(\frac{W_0}{50}, 1\right) \quad (12)$$

175 Finally the factor  $a_{up}$  expresses two combined effects. The first one corrects the amount of  
 176 pyrolysis gases produced by the airstream below the streamline which enters the flame base at  
 177 point  $E$  (see Fig. 1). Indeed, this zone delimited by points  $BB_0A_0E$  was approximated by the  
 178 surface of the triangle  $BB_0F$ . The second effect corresponds to the heat remaining in the fuel  
 179 burning particles area when the heat released to the upper part of the fuel is removed. This  
 180 effect is assumed to be proportional to the total leaf area  $S_t$  ( $S_t = s h \beta_t$ , where  $h$  is the fuel bed  
 181 depth and  $\beta_t$  the total packing ratio) and inversely proportional to the flux of gases moving  
 182 upward i.e the upward gas velocity in the preheating zone which is proportional to the root  
 183 square of the fuel bed depth (due to buoyancy forces). The parameter  $a_{up}$  is modelled according  
 184 to the following empirical relationship:

$$185 \quad a_{up} = a_M s \beta_t \sqrt{h} \quad (13)$$

186 With  $a_M$  being an empirically parameter fitted to a training dataset through a calibration  
 187 protocol. After this fitting,  $a_M$  is considered a constant for the application of the model to  
 188 simulating fire spread in shrubland fuel complexes.

189 Finally, combining Eqns 11-13, Eqn 10 yields:

190  $a_c = a_{MS} \beta_t \sqrt{h} \min\left(\frac{W_0}{50}, 1\right) \frac{S}{S_t}$  (14)

191 *Changes in the convective heat contribution*

192 According to (Balbi *et al.* 2020) the convective heat flux is modelled as:

193  $\phi_c = \frac{\Delta H}{2\tau_0} \sigma s \min(h, \delta) \tan \gamma_c$  (15)

194 Where  $\Delta H$  and  $\tau_0$  are the heat of combustion of pyrolysis gases and the flame residence time  
 195 parameter, respectively. The angle  $\gamma_c$  is defined as in Fig. 1 by:

196  $\tan \gamma_c = \tan \alpha + \frac{U(L)}{u_c}$  (16)

197 where  $U(L)$ ,  $u_c$  and  $\alpha$  are horizontal wind speed at point  $B$ , upward gas velocity at the top of  
 198 the flame base and terrain slope angle, respectively.

199 Due to the vertical dimension of the fuel bed, namely due to the existence of live fuels on its  
 200 top, the definition of  $U(L)$  is slightly changed. It is expressed as a function of wind velocity  $U$   
 201 at flame mid-height and drag forces:

202  $U(L) = U \frac{h}{h + \frac{H}{2}} \exp(-K^* L)$  (17)

203 where  $H$ ,  $L$  and  $K^*$  are the flame height, flame depth and a drag coefficient, respectively. This  
 204 decrease in wind velocity along the flame base has been reported by Anderson *et al.* (2010).

205 Flame depth  $L$  is equal to the product of the  $R$  and flame residence time  $\tau$  ( $L = R \tau$ ). In the  
 206 current formulation flame residence time is estimated from surface area-to-volume ratio ( $\tau =$   
 207  $\tau_0/s$ ) as parameterised by Anderson (1969). The modelling of drag forces is slightly modified  
 208 in order to take into account the whole fuel (live and dead fuel) and the drag coefficient  $K^*$  is

209 assumed to linearly depend on fuel porosity ( $K^* = K_1 s \beta_t$ ) with  $K_1$  is a drag coefficient. So Eqn  
 210 17 yields

$$211 \quad U(L) = U \frac{h}{h + \frac{h}{2}} \text{Exp}(-KR) \quad (18)$$

212 where the drag forces law  $K$  is defined as follows:

$$213 \quad K = \frac{\beta_t}{\min\left(\frac{W_0}{50}, 1\right)} \quad (19)$$

214 Note that, contrary to (Balbi *et al.* 2020), the model coefficient  $K_1$  depends on  $W_0$  and thus it is  
 215 removed from Eqn 19 and is not a model parameter anymore.

216 Finally, after some simplifications (see Appendix C for further calculus), combining Eqns 4,  
 217 15-16 and 18-19 yields

$$218 \quad R_c = a_M \min\left(\frac{W_0}{50}, 1\right) \frac{\Delta H \rho_a T_a s \sqrt{h}}{2q(s_t + 1) \rho_v T} \left( \frac{(s_t + 1) \rho_v T}{\tau_0 \rho_a T_a} \min\left(S, \frac{2\pi S}{S_t}\right) \tan \alpha + U \text{Exp}\left(-\frac{\beta_t}{\min\left(\frac{W_0}{50}, 1\right)} R\right) \right) \quad (20)$$

219 *Main equations of the improved model*

220 Combining Eqns 2-4, 8, 9, 15 and 20, the equation (1) of the ROS is written in its detailed  
 221 expression:

$$222 \quad R = \min\left(\frac{S_t}{\pi}, 1\right) \left(\frac{S}{S_t}\right)^2 \frac{BT^4}{\beta \rho_v q} + AR \frac{(1 + \sin \gamma - \cos \gamma)}{1 + \frac{R \cos \gamma}{sr_{00}}} +$$

$$223 \quad + a_M \min\left(\frac{W_0}{50}, 1\right) \frac{\Delta H \rho_a T_a s \sqrt{h}}{2q(s_t + 1) \rho_v T} \left( \frac{(s_t + 1) \rho_v T}{\tau_0 \rho_a T_a} \min\left(S, \frac{2\pi S}{S_t}\right) \tan \alpha + U \text{Exp}\left(-\frac{\beta_t}{\min\left(\frac{W_0}{50}, 1\right)} R\right) \right) \quad (21)$$

224 where the radiative factor  $A$  is defined as following:

$$225 \quad A = \min\left(\frac{S}{2\pi S_t}, \frac{S}{S_t}\right) \frac{\chi_0 \Delta H}{4q} \quad (22)$$

226 Equations for the flame tilt angle  $\gamma$ , flame height  $H$  and flame temperature  $T$  are not changed  
227 since (Balbi *et al.* 2020):

$$228 \quad \tan \gamma = \tan \alpha + \frac{U}{u_0} \quad (23)$$

$$229 \quad T = T_a + \frac{\Delta H (1 - \chi)}{(s_t + 1) C_{pa}} \quad (24)$$

$$230 \quad H = \frac{u_0^2}{g \left( \frac{T}{T_a} - 1 \right)} \quad (25)$$

231 Eqns 21-25 can be summed up in one non linear algebraic equation (Eqn 21). As the ROS given  
232 in eqn 21 depends on environmental parameters (wind velocity, terrain slope angle, ignition  
233 line length, ambient temperature), fuel characteristics (dead FMC, total leaf area, packing ratio,  
234 fuel density, surface area-to-volume ratio, heat of combustion of pyrolysis gases, specific heat  
235 of fuel) and on the ROS itself, an iterative method is necessary to numerically solve this  
236 equation. A convergent series is built in which its first term is the solution of the radiative model  
237 defined by Eqn A2 (solution of second order polynomial). Then a loop is performed up to  
238 convergence.

239 Note that Eqn 21 depends on four model parameters: the air-pyrolysis gases mass ratio in the  
240 flame body ( $s_t$ ), a model coefficient ( $r_{00}$ ), a radiant factor ( $\chi_0$ ) and a fitted model parameter ( $a_M$ ).  
241 Of these all but  $a_M$  have been determined by Balbi *et al.* (2020) and are not expected to vary for  
242 the current model parameterization. Parameter  $a_M$  needs to be determined for field scale fires.  
243 As the various parameter values are assumed to not vary with fuel characteristics in free-  
244 spreading shrubland fires, the proposed model is fully predictive.

245 **Data**

246 Two distinct field scale, experimental fire datasets were used in the present analysis. One for  
247 model calibration and the other for model evaluation against independent data.

#### 248 *Model calibration*

249 Model calibration for its application to field scale shrubland fires required the estimation of the  
250  $a_M$  parameter. This model calibration used the experimental dataset published by Bilgili and  
251 Saglam (2003). This series was carried out in a shrubland fuel type (maquis) in Turkey. These  
252 authors reported on a study where 25 experimental shrubland fires were conducted on flat  
253 ground under a range of weather and fuel conditions. Plot size was 20 x 30 m, for a 20 m  
254 ignition line and 30 m run. Wind speed (measured at 1.8 m height) varied between 0.27 m s<sup>-1</sup>  
255 and 4.11 m s<sup>-1</sup>. Fuel height ranged between 0.35 m and 1.15 m. Fine fuel load for the dead and  
256 live components ranged between 0.46 and 0.82 kg m<sup>-2</sup>, and 0.95 and 1.49 kg m<sup>-2</sup>, respectively.  
257 Rate of fire spread varied between 0.013 and 0.11 m s<sup>-1</sup>. Further details on environmental  
258 conditions are given in the original publication. The estimation of the  $a_M$  parameter was based  
259 on the parameter that would minimize error and bias.

#### 260 *Sensitivity analysis*

261 A univariate sensitivity (Millington et al. 2009) analysis was conducted to quantify the effect  
262 of different fuel parameters on the modelled  $R$ . This analysis allows to identify the most  
263 influential variables in the  $R$  output. This analysis considers a benchmark simulation on flat  
264 ground under a 2 m s<sup>-1</sup> fuel level wind velocity, 10% dead fuel moisture content and a total fine  
265 fuel loading of 0.5 kg m<sup>-2</sup>. The full list of variables tested in the analysis and their default values  
266 is given in Table 2). The sensitivity analysis consists in calculating the percent change in ROS  
267 between the benchmark environment and the simulation with the fuel parameter perturbed by  
268 plus or minus 10%. This analysis considers the effects of the variable perturbation separately

269 applied to each fuel characteristic. Note that the perturbation of total fine fuel loading only  
270 affects the fine live fuel load because the dead fuel loading of  $0.3 \text{ kg m}^{-2}$  does not vary.

#### 271 *Model evaluation*

272 The proposed model predictive capacity was evaluated through its application to the data given  
273 in (Anderson *et al.* 2015) and (van Wilgen *et al.* 1985). Anderson *et al.* (2015) gathered a large  
274 set of experimental field fires from several regions of the world, namely from (New Zealand,  
275 Spain, Portugal, Australia and South Africa. The dataset in Anderson *et al.* (2015) provides the  
276 necessary detail relative to fire environment and fuel variables that allow the evaluation of Eqn  
277 (21). Of the 135 fires reported in the Anderson's database (Table A1 in (Anderson *et al.* 2015)),  
278 only fires where live fuel data, quantity and moisture content were given ( $n = 109$ ) were used.

279 This dataset was complemented with the data from 14 experimental fires conducted on fynbos  
280 vegetation by van Wilgen *et al.* (1985) in South Africa. This data was used by Anderson *et al.*  
281 (2015) but the data not given in their table A1. A usual power law wind profile (Peterson and  
282 Hennessey Jr 1978) is used to calculate the wind speed at fuel height necessary to run the  
283 proposed model.

#### 284 *Benchmark models used for model fit comparison purposes*

285 To better understand the relevance of the obtained model fit statistics, the evaluation statistics  
286 obtained with Eqn 21 are compared to the results obtained using other existent models against  
287 the same datasets. The following models were run against the (Anderson *et al.* 2015) dataset  
288 (equations of each model are provided in appendix A): (1) a predictive version of the radiative  
289 only model presented by Balbi *et al.* (2010) (Eqn A1), (2) the generic shrubland fire spread  
290 model provided by Anderson *et al.* (2015) (Eqn A4) and (3) the simplified physical model given  
291 by Balbi *et al.* (2020) (Eqn A5). We note that the evaluation data being use here was part of the  
292 dataset used to develop the Anderson *et al.* (2015) model.

### 293 *Statistics used*

294 The error between predicted and measured values is quantified through a number of metrics.  
295 To estimate the overall deviations we used the normalized mean square error (NMSE)  
296 introduced by Poli and Cirillo (1993). The fractional bias (FB, see (Warner *et al.* 2004)) was  
297 used to understand the model's under-predictions or over-predictions trends. This normalized  
298 tool makes the bias non-dimensionless. It varies from -2 to +2 and a positive value indicates an  
299 overestimated measured value. An ideal model is obtained for an ideal value of zero for NMSE  
300 and FB. Residuals ( $\text{res} = \text{predicted } R - \text{observed } R$ ) and relative error ( $\text{res}/\text{observed } R$ ) are also  
301 used in the analysis.

## 302 **Numerical Results**

### 303 *Model calibration*

304 The proposed model (Eqn 21) exhibits four model parameters. The values of three of these  
305 parameters ( $s_t = 16$ ,  $r_{00} = 2.5 \times 10^{-5}$ ,  $\chi_0 = 0.3$ ) are set in (Balbi *et al.* 2020) and do not change in  
306 the proposed model. Indeed these three parameters are related to flame radiation whose  
307 modelling did not evolved. The  $a_M$  parameter was found to be most suitable parameter to  
308 parametrize the model for its application against outdoor fires. A value of 0.025 for the  $a_M$   
309 parameter leads to the best agreement between the predicted and the observed ROS in (Bilgili  
310 and Saglam 2003) dataset (see Fig. 2). This value and the ensuing fit produce a small deviation  
311 (NMSE=0.038) without bias (FB=0.00). This parameter is assumed to be a universal  
312 coefficient, with its value not changing when applying the model to other field fires, i.e. it is  
313 independent of environmental, topographical and fuel conditions.

### 314 *Model behaviour*



315 Fig. 3 illustrates the predicted  $R$  with changes in some of the most influential environmental  
316 variables in shrubland fires, namely wind speed, fuel moisture and fuel height (e.g. (Fernandes  
317 *et al.* 2000; Anderson *et al.* 2015)). Benchmark values are given in Table 2.

318 Modelled ROS against wind velocity for 5 different values of the dead fuel load (0.1, 0.15, 0.2,  
319 0.25 and 0.3 kg m<sup>2</sup>) shows  $R$  increasing linearly with wind speed (Fig 3a) for the lower fuel  
320 loads (0.1 and 0.15 kg m<sup>2</sup>). For the higher fuel loads simulated (0.2, 0.25 and 0.3 kg m<sup>2</sup>) the  
321 model suggests a slow increase of the ROS for low wind speeds and then a faster increase for  
322 wind speeds greater than 2.5 m s<sup>-1</sup>. Fig. 3a also shows that for each value of wind speed, the  
323 ROS increases with the dead fuel load but the difference between ROS calculated for two  
324 consecutive dead fuel loads tends to decrease with increasing fuel load. This suggests that the  
325 model identify the relative influence of fuel load on the ROS to gradually decline with  
326 increasing fuel loads. For example, for a 10 m s<sup>-1</sup> wind speed, the variation of the ROS  
327 calculated from consecutive dead fuel loads are 0.12, 0.10, 0.07 and 0.05 m s<sup>-1</sup>. These  
328 simulations assume a constant fuel bed height, with changes in fuel load affecting the fuel layer  
329 bulk density, a fuel bed parameter influencing a number of fluid flow and heat transfer  
330 efficiencies (Rothermel 1972; Anderson *et al.* 2015). The effect of fuel load, fuel height and  
331 bulk density on fire propagation in shrubland vegetation are intimately connected, and it is often  
332 difficult, if not impossible, to extract the effect of one variable independently from the effect of  
333 the other two in natural fuel beds. We did not explicitly investigate the effect of fuel bulk density  
334 on model behaviour in this analysis due to space constraints.

335 The effect of FMC on ROS is presented in Fig. 3b, using the ratio the predicted ROS and an  
336 hypothetical ROS for zero FMC ( $R/ROS(m=0)$ ), as per (Morvan 2013). The observed decay in  
337  $ROS/ROS(m=0)$  expressing the relative influence of FMC on ROS follows the trends obtained  
338 by Balbi *et al.* (2020), by simulations carried out with FireStar2D (Morvan 2013) and the  
339 exponential decay in ROS as a function of FMC modelled by Anderson *et al.* (2015), Fernandes

340 *et al.* (2009) or Rossa *et al.* (2016). As found by Anderson *et al.* (2015), the effect is not  
341 pronounced.

342 The influence of fuel bed height on ROS is illustrated in Fig. 3c for four different wind  
343 velocities (2.5, 5, 7.5 and 10 m s<sup>-1</sup>). The ROS is found to increase with fuel height  
344 independently of wind speed. A doubling in fuel height from 1 to 2 meters results in a 31%  
345 increase on average in *R* but it is noticeable that this increase in the *R* output is more pronounced  
346 for low wind speeds (42.8%, 31.4%, 27.3%, 25.2%, for wind speeds of 2.5, 5, 7.5 and 10 m s<sup>-1</sup>  
347 respectively). Results also indicate that the higher the fuel bed height the lower the effect of  
348 height increases (whatever the wind speed).

#### 349 *Sensitivity analysis*

350 The univariate sensitivity analysis shows that the fuel characteristics leading to the most  
351 important variation in ROS are surface area-to-volume ratio, fuel density, heat of combustion  
352 of pyrolysis gases and specific heat (see Table 2). All these variables showed an effect  
353 approximately proportional to the 10% perturbation. It is important to notice that these  
354 variables, with the exception of surface area-to-volume ratio, tend to be considered constant in  
355 fire behaviour modelling. The ±10% change in fuel height and dead fuel moisture content result  
356 in an approximate 5% change in the *R* output. Fuel load parameters, dead and total, were the  
357 fuel variables showing the least impact on the change in *R*, with the perturbation leading to an  
358 absolute percent change varying between 0.8 and 3.5%. These results are restricted to the range  
359 of the default values used in the sensitivity analysis. A more comprehensive sensitivity analysis  
360 over the natural range of the fuel variables tested would likely show areas where the model will  
361 be more sensitive to changes in environment conditions.

#### 362 *Model evaluation and comparison*

363 The scatter diagram plotted in Fig. 4a compares predicted and observed ROS for fires conducted  
364 in New Zealand (NZ), Australia (WC and SA), Portugal (PT), Spain (SP) and South Africa  
365 (SoA). The solid line and dashed lines represent the line of perfect agreement and  $\pm 35\%$  error  
366 levels, respectively. A good overall agreement is found with an average NMSE of 0.132 and a  
367 slight under-estimation of the predicted ROS (FB=-0.03). Larger relative errors presented in  
368 Fig. 4c seem to concentrate in the lower rates of fire spread. Table 3 displays the full model  
369 performance results for each experimental series. It is noticeable that deviation results are very  
370 low (NMSE close to 0) for all the experimental fire series, with the exception of the Portugal  
371 fire dataset that yield a NMSE of 0.308. Fig. 4c illustrates behaviour with the Portugal fires  
372 subset showing the largest relative error of all data subsets. Fig. 5a and b plot residuals and  
373 relative error as a function of observed ROS in four broad classes. The residual distribution  
374 shows the model to produce unbiased results within the three lower  $R$  classes ( $R < 0.5 \text{ m s}^{-1}$ ) and  
375 a higher under-prediction for the faster spreading fires ( $R > 0.5 \text{ m s}^{-1}$ ). The analysis of the  
376 percent error shows that this increase in residuals for faster fires is associated with the lowest  
377 percent errors (Fig. 5b). The model error in a relative sense decreases considerably as the  
378 observed  $R$  increases.

### 379 *Analysis of modelled convective and radiative heat transfer*

380 The bubble diagram (Fig. 6) plots the convective ( $R_c$ , Eqn 3) v. radiative ( $R_b+R_r$ , Eqns 2 and 4)  
381 contributions calculated on the datasets of Anderson *et al.* (2015) and Bilgili and Saglam  
382 (2003). Wind speed is the third variable and the larger the bubble sizes, the larger the wind  
383 speed. The solid line represents the perfect equilibrium between these two contributions. Fig. 6  
384 shows the model identifying convection as the main heat transfer mechanism for 79.7% of the  
385 fires (118 of 148). Radiation is identified as dominant in all the 10 fires of one of the Australia  
386 fire group (SA). If convection is found to drive all the South African (SoA), Turkish (TU) and  
387 Australian (WC), the convective contribution to the ROS also outweighs the radiative effects

388 in the major part of New Zealander (NZ), Portuguese (PT) and Spanish (SP) fires (89.2%,  
389 79.2% and 72.73% respectively). So, overall, the model formulation identified convection as  
390 the most influential heat transfer mechanism driving fire propagation. As an exception, two  
391 Spanish fires burning under nil, or zero, wind conditions had radiative heat transfer largely  
392 dominating fire propagation.

### 393 *Comparison with other models*

394 The comparison of model fit statistics obtained with the eqn 21 model and previous published  
395 models is presented in Table 3. The Balbi *et al.* (2010) radiative model yields the largest NMSE  
396 and a strong underestimation. The results obtained by the Anderson *et al.* (2015) empirical  
397 model (NMSE=0.180, FB=-0.05) were expected to a good approximation of the observed ROS  
398 as the data used in this evaluation was part of the data used in the development of the model  
399 (Eqn A4). The Balbi *et al.* (2020) model also produced very encouraging results, with an overall  
400 NMSE of 0.183 and a FB of -0.02. This corroborates Balbi *et al.* (2020) claims that their model  
401 could be used at field scale even if it was developed at laboratory scale. Overall, the eqn 21  
402 model produced the best results of all the models analysed, with small overall deviations  
403 (NMSE=0.132) and a bias close to zero (FB=-0.03). Fig. 7 presents the comparison between  
404 the previous models as a scatter plot; the Balbi *et al.* (2010) radiative model was removed from  
405 this plot because of its poor agreement with observed data.

## 406 **Discussion**

### 407 *Effect of dominant environmental variables*

408 The proposed model produces a quasi-linear relationship between  $R$  and wind speed, with the  
409 increase in wind speed resulting in an increase in  $R$  following expectations from laboratory and  
410 field observations (Bilgili and Saglam 2003; Mendes-Lopes *et al.* 2003; Butler *et al.* 2019). The

411 wind speed effect depends on other fuel characteristics, due to the effect of structural fuel  
412 characteristics on heat transfer processes. As example, fuel load affects the radiative coefficient  
413 (0.1 and 0.15 kg m<sup>-2</sup> lead to  $A=0.27$  and  $A=0.41$ , respectively), and this effect is dependent on  
414 wind speed as well. The linear (when  $A < 1/2$ ) or quasi-linear ( $A > 1/2$ ) ROS trend agrees with  
415 experimental results presented by Beer (1991) on match splints, Rothermel and Anderson  
416 (1966) on ponderosa pine and white pine needles fuel beds or Cheney *et al.* (1993) on grass  
417 fuel (where the exponent modelling the effect of wind speed on ROS,  $R \propto aU^b$  is close to 1).

418 At zero wind speed, both the convective effects and the radiative contribution from the flame  
419 body are nil (on flat ground) or close to zero (on sloped ground) and the fire is driven by the  
420 flame base radiation ( $R_b$ ). As wind speed  $U$  increases, the convective ( $R_c$ ) and radiative ( $R_r$ )  
421 contributions increase as well, directly through  $U$  in  $R_c$  (Eqn 20) and through the increasing  
422 flame tilt angle for  $R_r$  (Eqn 23). Note that if  $R_r$  is always an increasing function of the wind  
423 speed,  $R_c$  theoretically increases with wind speed up to a threshold wind speed value because  
424 of the exponential in its definition. This threshold value is difficult to assess but it is quite an  
425 extreme value of the wind speed. As example, selecting the ROS obtained in the numerical  
426 simulations for a dead fuel load of 0.2 kg m<sup>-2</sup>,  $R_c$  increases from 0 to 0.65 m s<sup>-1</sup>, which means  
427 that the threshold value is not reached, even for a 25 m s<sup>-1</sup> wind speed.

428 The model suggests an effect of fuel height on  $R$  to be dependent on other fire environmental  
429 variables. For low wind speeds a doubling in fuel height results in an approximately 50%  
430 increase in  $R$ , as found in the univariate sensitivity analysis. The same doubling in fuel height  
431 at high wind speeds can result in a 25 to 35% increase in  $R$ . The effect captured by the model  
432 is comparable to the effect captured by Anderson et al. (2015) model. Nonetheless, the physics  
433 nature of the proposed model allowed to capture a more nuanced effect as influenced by other  
434 environmental and fuel conditions. It is noticeable that the most sensitive fuel characteristics  
435 for the proposed model are intrinsic fuel properties (fuel characteristics directly related to the

436 fuel species). Nonetheless, it should be noticed that these intrinsic fuel characteristics vary  
437 within a narrow range comparatively to the range in structural variables such as fuel load or  
438 fuel height. Our results also show that the sensitivity of the model to the variation in the extrinsic  
439 fuel characteristics (FMC, height and load) does not cause large errors on the ROS output. This  
440 is encouraging from the point of view that within an operational fire simulation setting, an error  
441 in these estimates leads to a controlled error on the ROS.

#### 442 *Model predictive performance*

443 The overall comparison between predicted and observed ROS on the Anderson's dataset leads  
444 to a NMSE of 0.132 with a bias close to zero (FB=-0.03). We consider this to be a very good  
445 result for the application of fire spread models at a field scale, especially when the model was  
446 applied to shrubland fires from different sources and covering a broad range of fuel structures.  
447 The results showed that the model performance was worse for the dataset of Portuguese fires,  
448 where the NMSE was more than doubled the average NMSE for all fires. This result was  
449 observed in (Anderson *et al.* 2015) analysis, with the Portugal fire subset showing a distinct  
450 dynamics than the remaining data. The source of this differences was unclear to Anderson *et*  
451 *al.* (2015).

452 Our results suggest the model relative accuracy to increase with an increase in observed rate of  
453 spread, or severity of burning conditions. For a model designed to be used operationally, errors  
454 in the slow spreading fires are somewhat inconsequential. The reduction in relative error for  
455 the fast spreading fires ensures the model can be better trusted under operational conditions  
456 where simulations for these type of fires are most needed.

457 Overall, the good agreement between predicted and observed ROS presented by the proposed  
458 model, with errors comparable but slightly lower than obtained with Anderson *et al.* (2015)  
459 model, suggests that it is qualified to be used to predict the propagation of shrubland fires in an

460 operational setting. The current formulation predicted shrubland fire spread more accurately  
461 than the radiative model derived from (Balbi *et al.* 2010) which has been implemented in the  
462 Forefire simulator (Filippi *et al.* 2011).

### 463 *Heat transfer mode*

464 The relative contribution of the convective and radiative heat transfer to the ROS was also  
465 analysed. The ratio of convective to radiative heat transfer for the experimental shrubland fires  
466 used in model evaluation was above 1 for 79.7% of the fires, implying convection to be the  
467 dominant heat transfer mode in these fires. These results agree with the simulations conducted  
468 by Morvan and Dupuy (2004) on mediterranean shrubs. The convection dominance is more  
469 pronounced when the model is tested against the NZ data which present the higher wind speeds  
470 and high fuel loads. The same effect is found for the South African fires which has the second  
471 higher wind speed average of the whole dataset. So convection seems to be more dominant with  
472 high wind speeds. This trend agrees with the main tendencies provided by detailed physical  
473 models such as FireStar3D (Morvan *et al.* 2018) in which convection increases with wind  
474 speed. It was expected because of the definition of the ROS in the model (Eqn 21) in which the  
475 convective contribution linearly depends on wind speed. But according to the ROS expression  
476 of the proposed model, an increasing ROS reduces the value of the exponential in Eqn 21 and  
477 very fast ROS will finally cause a decreasing convective contribution to the ROS. This decrease  
478 happens for extreme wind speed values (no decrease was found in the numerical simulations  
479 performed under wind speeds up to  $25 \text{ m s}^{-1}$ ). Radiation prevails in all the fires of the Australian  
480 (SA) group which are conducted in a semi-arid environment (smaller average dead and live  
481 FMC and low fuel loads). Radiation is also dominant for fires spreading under zero wind  
482 conditions because the convective contribution is zero (Eqn 21) and the ROS is mainly driven  
483 by the flame base radiation ( $R = R_b$ ).

## 484 **Conclusion**

485 This work deals with the adaptation of the Balbi *et al.* (2020) convective-radiative surface fire  
486 propagation model originally developed to describe laboratory scale fires, to fires propagating  
487 at a field scale in shrubland fuels. The improved model is a simplified physical model which  
488 takes into account convective and radiative effects as heat transfer mechanisms and is designed  
489 to allow its application under operational conditions. The main physical characteristics of the  
490 fire front are assessed through algebraic equations. The ROS is calculated using a non-linear  
491 algebraic equation solved through an iterative method. It depends on environmental (wind  
492 velocity, ambient temperature), topographical (terrain slope angle) conditions and a number of  
493 intrinsic and extrinsic fuel characteristics (e.g. FMC, thickness, packing ratio, surface area to  
494 volume ratio, dead and live fuel load). The living part of the fuel is mainly taken into account  
495 through the contribution of live fuel load.

496 Like other simplified physical models, the improved model is not able to use a detailed  
497 description of the fuel complex when the available biomass is composed of multiple species or  
498 layers with distinct physical structures, it needs an equivalent idealized fuel description in order  
499 to be run.

500 The level of detail in the physical conservation laws, the low computational cost (faster than  
501 real time) and the observed good agreement obtained against independent data are encouraging  
502 results obtained in the present work. With model parameterization requiring only a restricted  
503 number of experimental fires, the model framework has potential to be extended to different  
504 fuel types such as grasslands and conifer forests, by using existent datasets. The model can be  
505 implemented in fire spread simulators such as ForeFire (Filippi *et al.* 2011) and it is currently  
506 being tested within the couple atmosphere-fire model WRF-Sfire (Kochanski *et al.* 2013).

## 507 **Conflict of Interest**



508 The authors declare they have no conflicts of interest.

## 509 **Acknowledgements**

510 The present work was supported in part by the Corsican Region under Grant GOLIAT 2020–  
511 2023. The authors also wish to thank Dr. E. Bilgili for sharing its corrected data on his field  
512 experiments.

## 513 **References**

- 514 Albini FA (1985) A Model for Fire Spread in Wildland Fuels by-Radiation. *Combustion*  
515 *Science and Technology* **42**, 229–258. doi:10.1080/00102208508960381.
- 516 Albini FA (1986) Wildland Fire Spread by Radiation - a Model Including Fuel Cooling by  
517 Natural Convection. *Combustion Science and Technology* **45**, 101–113.
- 518 Anderson HE (1969) Heat transfer and fire spread. (U.S. Department of Agriculture, Forest  
519 Service, Research Paper INT-69)
- 520 Anderson WR, Catchpole EA, Butler BW (2010) Convective heat transfer in fire spread through  
521 fine fuel beds. *International Journal of Wildland Fire* **19**, 284–298.  
522 doi:10.1071/WF09021.
- 523 Anderson WR, Cruz MG, Fernandes PM, McCaw L, Vega JA, Bradstock RA, Fogarty L, Gould  
524 J, McCarthy G, Marsden-Smedley JB, Matthews S, Mattingley G, Pearce HG, Van Wilgen  
525 BW (2015) A generic, empirical-based model for predicting rate of fire spread in  
526 shrublands. *International Journal of Wildland Fire* **24**, 443–460. doi:10.1071/WF14130.
- 527 Andrews PLPP (1986) BEHAVE: Fire Behavior Prediction and Fuel Modeling System - BURN  
528 Subsystem, Part 1. (Ogden, UT 84401) <http://digitalcommons.usu.edu/barkbeetles/151/>.

- 529 Balbi JH, Chatelon FJ, Morvan D, Rossi JL, Marcelli T, Morandini F (2020) A convective–  
530 radiative propagation model for wildland fires. *International Journal of Wildland Fire* **29**,  
531 723–738. doi:10.1071/WF19103.
- 532 Balbi J-H, Morandini F, Silvani X, Filippi JB, Rinieri F (2009) A physical model for wildland  
533 fires. *Combustion and Flame* **156**, 2217–2230. doi:10.1016/j.combustflame.2009.07.010.
- 534 Balbi J-H, Rossi J-L, Marcelli T, Chatelon F-J (2010) Physical Modeling of Surface Fire Under  
535 Nonparallel Wind and Slope Conditions. *Combustion Science and Technology* **182**, 922–  
536 939. <http://www.tandfonline.com/doi/abs/10.1080/00102200903485178>.
- 537 Balbi J-H, Rossi J-L, Marcelli T, Santoni P-A (2007) A 3D Physical Real-Time Model of  
538 Surface Fires Across Fuel Beds. *Combustion Science and Technology* **179**, 2511–2537.  
539 <http://dx.doi.org/10.1080/00102200701484449>  
540 <http://www.tandfonline.com/doi/pdf/10.1080/00102200701484449>.
- 541 Beer T (1991) The interaction of wind and fire. *Boundary-Layer Meteorology* **54**, 287–308.  
542 doi:10.1007/BF00183958.
- 543 Bilgili E, Saglam B (2003) Fire behavior in maquis fuels in Turkey. *Forest Ecology and*  
544 *Management* **184**, 201–207. doi:10.1016/S0378-1127(03)00208-1.
- 545 Butler B, Quarles S, Standohar-Alfano C, Morrison M, Jimenez D, Sopko P, Wold C, Bradshaw  
546 L, Atwood L, Landon J, O’Brien J, Hornsby B, Wagenbrenner N, Page W (2019)  
547 Exploring fire response to high wind speeds: Fire rate of spread, energy release and flame  
548 residence time from fires burned in pine needle beds under winds up to 27 m s<sup>-1</sup>.  
549 *International Journal of Wildland Fire* **29**, 81–92. doi:10.1071/WF18216.
- 550 Castro Rego FMC, Moreno Rodriguez JM, Vallejo Calzada VR, Xanthopoulos G (2018) Forest  
551 Fires - Sparking firesmart policies in the EU (Nicolas Faivre, Ed.). Publications Office of

552 the European Union, (Luxembourg) doi:10.2777/181450.

553 Catchpole WR, Catchpole EA, Butler BW, Rothermel RC, Morris GA, Latham DJ (1998) Rate  
554 of Spread of Free-Burning Fires in Woody Fuels in a Wind Tunnel. *Combustion Science  
555 and Technology* **131**, 1–37. doi:10.1080/00102209808935753.

556 Chandler C, Cheney P, Thomas P, Trabaud L, Williams D (1983) ‘Fire in forestry. Volume 1.  
557 Forest fire behavior and effects. Volume 2. Forest fire management and organization.’  
558 (John Wiley & Sons, Inc.: New York, NY, USA)

559 Chatelon FJ, Balbi JH, Morvan D, Rossi JL, Marcelli T (2017) A convective model for  
560 laboratory fires with well-ordered vertically-oriented fuel beds. *Fire Safety Journal* **90**,  
561 54–61. doi:10.1016/j.firesaf.2017.04.022.

562 Cheney N, Gould J (1995) Fire Growth in Grassland Fuels. *International Journal of Wildland  
563 Fire* **5**, 237–247. doi:https://doi.org/10.1071/WF9950237.

564 Cheney NP, Gould JS, Catchpole WR (1993) The Influence Of Fuel, Weather And Fire Shape  
565 Variables On Fire-Spread In Grasslands. *International Journal of Wildland Fire* **3**, 31–44.  
566 doi:10.1071/WF9930031.

567 Cheney NP, Gould JS, Catchpole WR (1998) Prediction of fire spread in grasslands.  
568 *International Journal of Wildland Fire* **8**, 1–13. doi:10.1071/WF9980001.

569 Cruz MG, McCaw WL, Anderson WR, Gould JS (2013) Fire behaviour modelling in semi-arid  
570 mallee-heath shrublands of southern Australia. *Environmental Modelling and Software* **40**,  
571 21–34. doi:10.1016/j.envsoft.2012.07.003.

572 Dupuy J-L, Fargeon H, Martin-StPaul N, Pimont F, Ruffault J, Guijarro M, Hernando C,  
573 Madrigal J, Fernandes P (2020) Climate change impact on future wildfire danger and

574 activity in southern Europe: a review. *Annals of Forest Science* **77**, 24.  
575 doi:10.1007/s13595-020-00933-5.

576 European Science & Technology Advisory Group (2020) Evolving Risk of Wildfires in Europe  
577 - The changing nature of wildfire risk calls for a shift in policy focus from suppression to  
578 prevention. (Brussels, Belgium) [https://www.undrr.org/publication/evolving-risk-](https://www.undrr.org/publication/evolving-risk-wildfires-europe-thematic-paper-european-science-technology-advisory)  
579 [wildfires-europe-thematic-paper-european-science-technology-advisory](https://www.undrr.org/publication/evolving-risk-wildfires-europe-thematic-paper-european-science-technology-advisory).

580 Fernandes PAM (2001) Fire spread prediction in shrub fuels in Portugal. *Forest Ecology and*  
581 *Management* **144**, 67–74. doi:10.1016/S0378-1127(00)00363-7.

582 Fernandes PM (2013) Fire-smart management of forest landscapes in the Mediterranean basin  
583 under global change. *Landscape and Urban Planning* **110**, 175–182.  
584 doi:10.1016/j.landurbplan.2012.10.014.

585 Fernandes PM, Botelho HS, Rego FC, Loureiro C (2009) Empirical modelling of surface fire  
586 behaviour in maritime pine stands. *International Journal of Wildland Fire* **18**, 698–710.  
587 doi:10.1071/WF08023.

588 Fernandes PM, Catchpole WR, Rego FC (2000) Shrubland fire behaviour modelling with  
589 microplot data. *Canadian Journal of Forest Research-Revue Canadienne De Recherche*  
590 *Forestiere* **30**, 889–899. doi:DOI 10.1139/cjfr-30-6-889.

591 Filippi JB, Bosseur F, Pialat X, Santoni PA, Strada S, Mari C (2011) Simulation of coupled  
592 fire/atmosphere interaction with the MesoNH-ForeFire models. *Journal of Combustion*  
593 **2011**,. doi:10.1155/2011/540390.

594 Finlay SE, Moffat A, Gazzard R, Baker D, Murray V (2012) Health impacts of wildfires. *PLoS*  
595 *Currents* **4**, e4f959951cce2c. doi:10.1371/4f959951cce2c.

- 596 Finney MA (1998) FARSITE: Fire Area Simulator - Model Development and Evaluation.  
597 doi:10.2737/RMRS-RP-4.
- 598 Finney MA, Forthofer J, Grenfell IC, Adam BA, Akafuah NK, Saito K (2013) A study of flame  
599 spread in engineered cardboard fuelbeds: Part I: Correlations and observations. In ‘Proc.  
600 Seventh Int. Symp. Scale Model.’, Hirosaki, Japan.(Hirosaki, Japan)
- 601 Frangieh N, Morvan D, Meradji S, Accary G, Bessonov O (2018) Numerical simulation of  
602 grassland fires behavior using an implicit physical multiphase model. *Fire Safety Journal*  
603 **102**, 37–47. doi:10.1016/j.firesaf.2018.06.004.
- 604 Grishin AM (1997) ‘Mathematical Modeling of Forest Fires and New Methods of Fighting  
605 Them.’ (FA Albin, Ed.). (Publishing House of the Tomsk University: Tomsk, Russia)  
606 <https://books.google.fr/books?id=MtScGwAACAAJ>.
- 607 Hammer RB, Radeloff VC, Fried JS, Stewart SI (2007) Wildland–urban interface housing  
608 growth during the 1990s in California, Oregon, and Washington. *International Journal of*  
609 *Wildland Fire* **16**, 255. doi:10.1071/WF05077.
- 610 Keane RE (2019a) Fire Ecology (SL Manzello, Ed.). *Encycl. ofWildfires Wildland-Urban*  
611 *Interface Fires* **37**, 350–353. doi:10.1007/978- 3- 319- 51727- 8\_254- 1.
- 612 Keane RE (2019b) LAI : Leaf Area Index (SL Manzello, Ed.). *Encycl. ofWildfires Wildland-*  
613 *Urban Interface Fires* **8**. doi:[https://doi.org/10.1007/978- 3- 319- 51727- 8\\_237- 1](https://doi.org/10.1007/978- 3- 319- 51727- 8_237- 1).
- 614 Keane RE, Drury SA, Karau EC, Hessburg PF, Reynolds KM (2010) A method for mapping  
615 fire hazard and risk across multiple scales and its application in fire management.  
616 *Ecological Modelling* **221**, 2–18. doi:10.1016/j.ecolmodel.2008.10.022.
- 617 Kochanski AK, Jenkins MA, Mandel J, Beezley JD, Clements CB, Krueger S (2013) Evaluation

618 of WRF-SFIRE performance with field observations from the FireFlux experiment.  
619 *Geoscientific Model Development* **6**, 1109–1126. doi:10.5194/gmd-6-1109-2013.

620 Koo E, Pagni P, Woycheese J, Stephens S, Weise D, Huff J (2005) A simple physical model  
621 for forest fire spread rate. *Fire Safety Science* **8**, 854–862. doi:10.3801/IAFSS.FSS.8-851.

622 Lattimer BY (2019) Heat Transfer from Fires (SL Manzello, Ed.). *Encycl. Wildfires Wildland-*  
623 *Urban Interface Fires* 1–10. doi:10.1007/978-3-319-51727-8\_38-1.

624 Linn RR, Cunningham P (2005) Numerical simulations of grass fires using a coupled  
625 atmosphere-fire model: Basic fire behavior and dependence on wind speed. *Journal of*  
626 *Geophysical Research Atmospheres* **110**, 1–19. doi:10.1029/2004JD005597.

627 Mandel J, Beezley JD, Kochanski AK (2011) Coupled atmosphere-wildland fire modeling with  
628 WRF 3.3 and SFIRE 2011. *Geoscientific Model Development* **4**, 591–610.  
629 doi:10.5194/gmd-4-591-2011.

630 McArthur AG (1966) ‘Weather and grassland fire behaviour.’ (Australia. Forestry and Timber  
631 Bureau: Canberra)

632 McCaffrey B (1979) Purely buoyant diffusion flames: some experimental results, NBSIR 79-  
633 1910. doi:NBSIR 79-1910.

634 Mell W, Jenkins MA, Gould J, Cheney P (2007) A physics-based approach to modelling  
635 grassland fires. *International Journal of Wildland Fire* **16**, 1–22. doi:10.1071/WF06002.

636 Mendes-Lopes JMC, Ventura JMP, Amaral JMP (2003) Flame characteristics, temperature–  
637 time curves, and rate of spread in fires propagating in a bed of *Pinus pinaster* needles.  
638 *International Journal of Wildland Fire* **12**, 67–84. doi:10.1071/WF02063.

639 De Mestre NJ, Catchpole EA, Anderson DH, Rothermel RC (1989) Uniform Propagation of a

640 Planar Fire front Without Wind. *Combustion Science and Technology* **65**, 231–2444.  
641 doi:10.1080/00102208908924051.

642 Meyer V, Becker N, Markantonis V, Schwarze R, van den Bergh JCJM, Bouwer LM, Bubeck  
643 P, Ciavola P, Genovese E, Green C, Hallegatte S, Kreibich H, Lequeux Q, Logar I,  
644 Papyrakis E, Pfuerscheller C, Poussin J, Przyluski V, Thieken AH, Viavattene C (2013)  
645 Review article: Assessing the costs of natural hazards – state of the art and knowledge  
646 gaps. *Natural Hazards and Earth System Sciences* **13**, 1351–1373. doi:10.5194/nhess-13-  
647 1351-2013.

648 Morvan D (2013) Numerical study of the effect of fuel moisture content (FMC) upon the  
649 propagation of a surface fire on a flat terrain. *Fire Safety Journal* **58**, 121–131.  
650 doi:10.1016/j.firesaf.2013.01.010.

651 Morvan D, Accary G, Meradji S, Frangieh N, Bessonov O (2018) A 3D physical model to study  
652 the behavior of vegetation fires at laboratory scale. *Fire Safety Journal* **101**, 39–52.  
653 doi:10.1016/J.FIRESAF.2018.08.011.

654 Morvan D, Dupuy JL (2004) Modeling the propagation of a wildfire through a Mediterranean  
655 shrub using a multiphase formulation. *Combustion and Flame* **138**, 199–210.  
656 doi:10.1016/j.combustflame.2004.05.001.

657 Morvan D, Dupuy JL, Porterie B, Larini M (2000) Multiphase formulation applied to the  
658 modeling of fire spread through a forest fuel bed. *Proceedings of the Combustion Institute*  
659 **28**, 2803–2809. doi:10.1016/S0082-0784(00)80702-X.

660 Morvan D, Méradji S, Accary G (2009) Physical modelling of fire spread in Grasslands. *Fire*  
661 *Safety Journal* **44**, 50–61. doi:10.1016/j.firesaf.2008.03.004.

662 Nelson Jr. RM, Adkins CW (1986) Flame characteristics of wind-driven surface fires.

- 663 *Canadian Journal of Forest Research* **16**, 1293–1300. doi:10.1139/x86-229.
- 664 Noble IR, Gill AM, Bary GAV (1980) McArthur's fire-danger meters expressed as equations.  
665 *Australian Journal of Ecology*. doi:10.1111/j.1442-9993.1980.tb01243.x.
- 666 Pagni PJ, Peterson TG (1973) Flame spread through porous fuels. *Symposium (International)*  
667 *on Combustion* **14**, 1099–1107. doi:10.1016/S0082-0784(73)80099-2.
- 668 Pastor E, Zárate L, Planas E, Arnaldos J (2003) Mathematical models and calculation systems  
669 for the study of wildland fire behaviour. *Progress in Energy and Combustion Science* **29**,  
670 139–153. doi:10.1016/S0360-1285(03)00017-0.
- 671 Perry GLW (1998) Current approaches to modelling the spread of wildland fire: a review.  
672 *Progress in Physical Geography* **22**, 222–245. doi:10.1177/030913339802200204.
- 673 Peterson EW, Hennessey Jr JP (1978) On the use of power laws for estimates of wind power  
674 potential. *Journal of applied meteorology* **17**, 390–394.
- 675 Pimont F, Ruffault J, Martin-StPaul NK, Dupuy JL (2019) Why is the effect of live fuel  
676 moisture content on fire rate of spread underestimated in field experiments in shrublands?  
677 *International Journal of Wildland Fire* **28**, 127–137. doi:10.1071/WF18091.
- 678 Poli AA, Cirillo MC (1993) On the use of the normalized mean square error in evaluating  
679 dispersion model performance. *Atmospheric Environment Part A, General Topics* **27**,  
680 2427–2434. doi:10.1016/0960-1686(93)90410-Z.
- 681 Radeloff VC, Hammer RB, Stewart SI, Fried JS, Holcomb SS, Mckeefry JF (2005) The  
682 Wildland–Urban Interface in the United States. *Communications Ecological Applications*  
683 **15**, 799–805. doi:10.1890/04-1413.
- 684 Rossa CG, Fernandes PM (2018) An Empirical Model for the Effect of Wind on Fire Spread



685 Rate. *Fire 2018, Vol 1, Page 31* **1**, 31. doi:10.3390/FIRE1020031.

686 Rossa CG, Veloso R, Fernandes PM (2016) A laboratory-based quantification of the effect of  
687 live fuel moisture content on fire spread rate. *International Journal of Wildland Fire* **25**,  
688 569–573. doi:10.1071/WF15114.

689 Rothermel RC (1972) A mathematical model for predicting fire spread in wildland fuels.  
690 (USDA Forest Service, Research Paper INT-115, Intermountain Forest and Range  
691 Experiment Station, Ogden, Utah)  
692 doi:[http://www.snap.uaf.edu/webshared/JenNorthway/AKFireModelingWorkshop/AKFireModelingWkshp/FSPRO Analysis Guide References/Rothermel 1972 INT-115.pdf](http://www.snap.uaf.edu/webshared/JenNorthway/AKFireModelingWorkshop/AKFireModelingWkshp/FSPRO%20Analysis%20Guide%20References/Rothermel%201972%20INT-115.pdf).

694 Rothermel RC, Anderson HE (1966) Fire spread characteristics determined in the laboratory.  
695 (USDA Forest Service, Research Paper INT-30, Intermountain Forest and Range  
696 Experiment Station, Ogden, Utah)

697 Running SW (2006) Is Global Warming causing more, large wildfires. *Science* **313**, 927–928.  
698 doi:10.1126/science.1130370.

699 Sağlam B, Bilgili E, Küçük Ö, Dinç Durmaz B (2008) Fire behavior in Mediterranean shrub  
700 species (Maquis). *African Journal of Biotechnology* **7**, 4122–4129.  
701 doi:10.5897/AJB08.782.

702 San-Miguel-Ayanz J, Moreno JM, Camia A (2013) Analysis of large fires in European  
703 Mediterranean landscapes: Lessons learned and perspectives. *Forest Ecology and  
704 Management* **294**, 11–22. doi:10.1016/j.foreco.2012.10.050.

705 Sullivan AL (2009a) Wildland surface fire spread modelling, 1990–2007. 1: Physical and quasi-  
706 physical models. *International Journal of Wildland Fire* **18**, 349–368.  
707 doi:10.1071/WF06144.

- 708 Sullivan AL (2009b) Wildland surface fire spread modelling, 1990–2007. 2: Empirical and  
709 quasi-empirical models. *International Journal of Wildland Fire* **18**, 369–386.  
710 doi:10.1071/WF06144.
- 711 Sullivan AL (2009c) Wildland surface fire spread modelling, 1990–2007. 3: Simulation and  
712 mathematical analogue models. *International Journal of Wildland Fire* **18**, 387–403.  
713 doi:10.1071/WF06144.
- 714 Tang Y, Zhong SY, Luo LF, Bian XD, Heilman WE, Winkler J (2015) The Potential Impact of  
715 Regional Climate Change on Fire Weather in the United States. *Annals of the Association  
716 of American Geographers* **105**, 1–21. doi:Doi 10.1080/00045608.2014.968892.
- 717 Viegas DX (2004) Slope and wind effects on fire propagation. *International Journal of  
718 Wildland Fire* **13**, 143–156. doi:10.1071/WF03046.
- 719 Warner S, Platt N, Urban JT, Heagy JF (2004) Comparisons of transport and dispersion model  
720 predictions of the joint urban 2003 field experiment. *Journal of Applied Meteorology* **43**,  
721 829–846. doi:10.1175/2007JAMC1802.1.
- 722 Weber RO (1991) Modelling fire spread through fuel beds. *Prog. Energy Combust. Sci.* **17**, 67–  
723 82. doi:10.1016/0360-1285(91)90003-6.
- 724 Weise DR, Koo E, Zhou X, Mahalingam S, Morandini F, Balbi JH (2016) Fire spread in  
725 chaparral - A comparison of laboratory data and model predictions in burning live fuels.  
726 *International Journal of Wildland Fire* **25**, 980–994. doi:10.1071/WF15177.
- 727 van Wilgen BW, Le Maitre DC, Kruger FJ (1985) Fire behaviour in South African  
728 fynbos(macchia) vegetation and predictions from Rothermel’s fire model. *Journal of  
729 Applied Ecology* **22**, 207–216. doi:10.2307/2403338.

730 Wolff MF, Carrier GF, Fendell FE (1991) Wind-aided firespread across arrays of discrete fuel  
731 elements. II. Experiment. *Combustion Science and Technology* **77**, 261–289.  
732 doi:10.1080/00102209108951731.

733 Wotton BM, Martell DL, Logan KA (2003) Climate change and people-caused fire occurrence  
734 in Ontario. *Climatic Change* **60**, 275–295. doi:10.1023/A:1026075919710.

735 Youssouf H, Liousse C, Roblou L, Assamoi E-M, Salonen R, Maesano C, Banerjee S, Annesi-  
736 Maesano I (2014) Non-Accidental Health Impacts of Wildfire Smoke. *International*  
737 *Journal of Environmental Research and Public Health* **11**, 11772–11804.  
738 doi:10.3390/ijerph11111772.

739

The manuscript proposes an extension of the Balbi model to the field scale. In addition to the necessary modelling section, we made a comparison between the results obtained with the proposed model and more than 100 experimental shrubland fires picked up in the literature. As the previous version of the Balbi model (developed at the laboratory scale) was published in IJWF (2020), and due to the very interesting comments from the fire community we received, we believe that the IJWF is the most appropriate outlet for the present manuscript given its broad reach to an operational and scientific readership.

The main interest of this work is to propose a simplified physical model designed to be used under operational conditions. The model takes explicitly into account the triangle of fire (wind, slope and main fuel characteristics), is fully predictive, faster than real time and can be easily used at the field scale with a good accuracy.

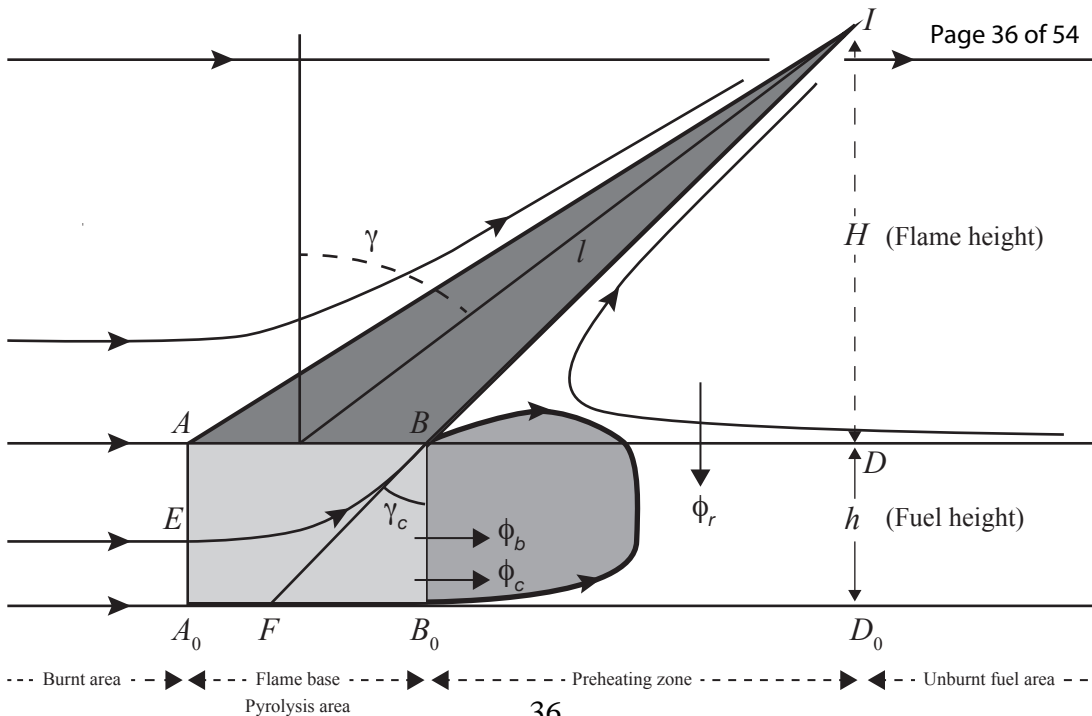

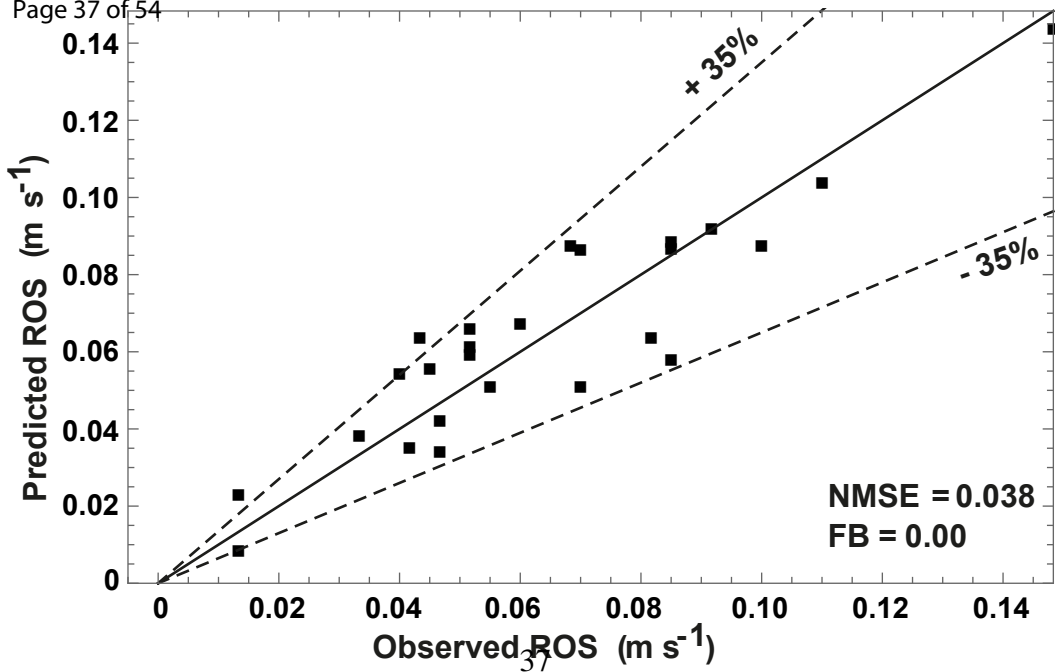

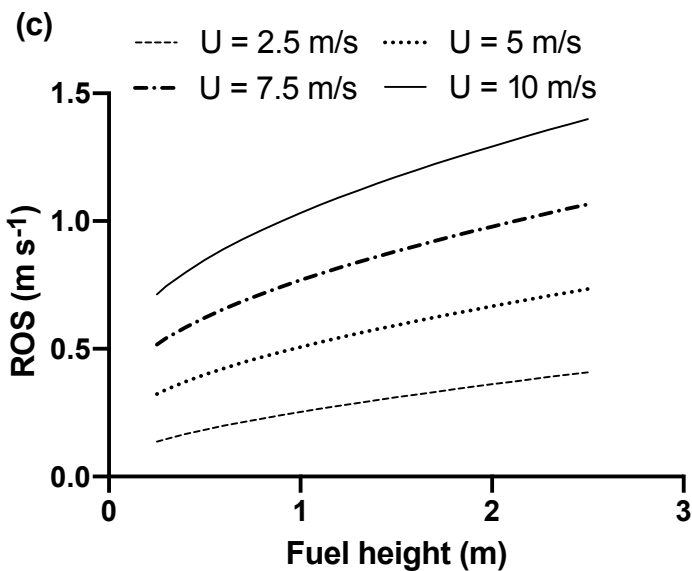
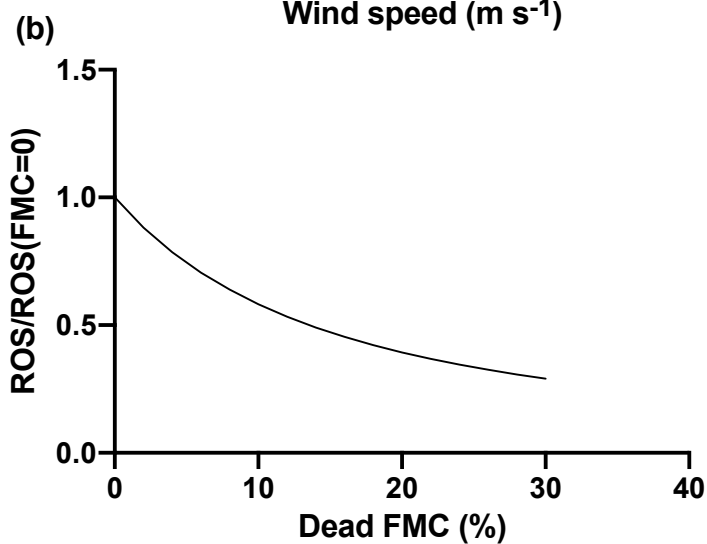
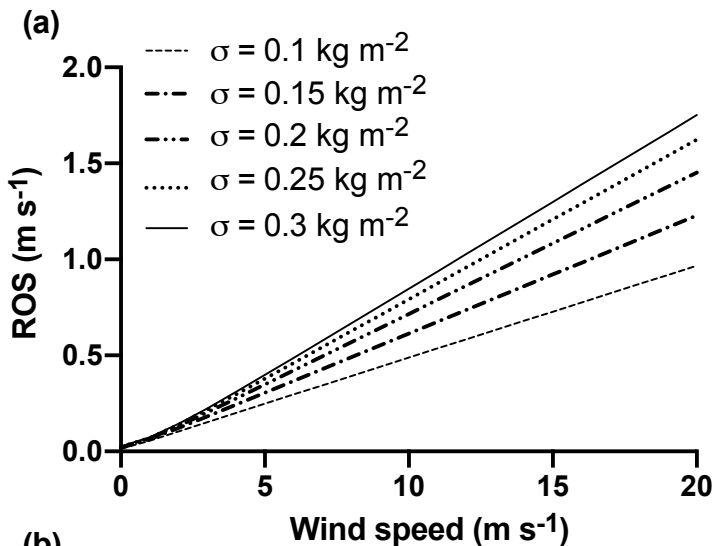

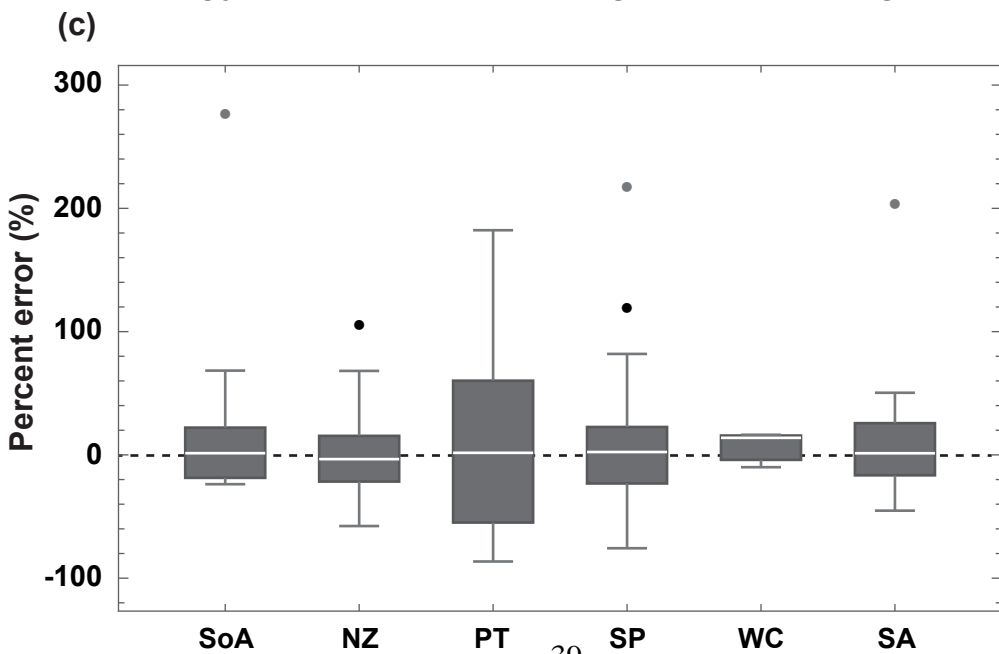
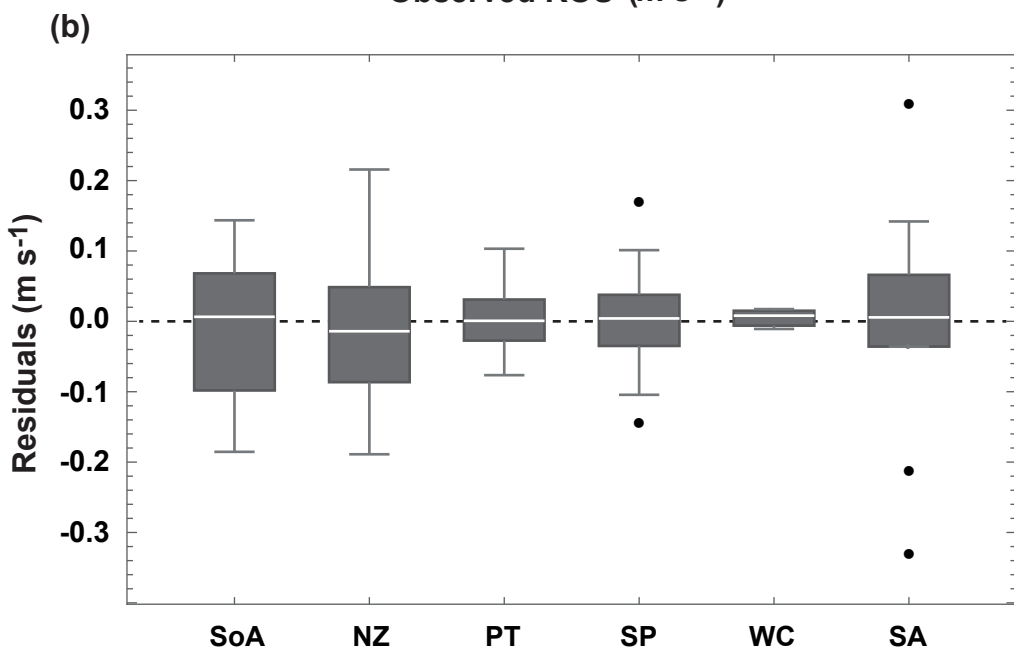
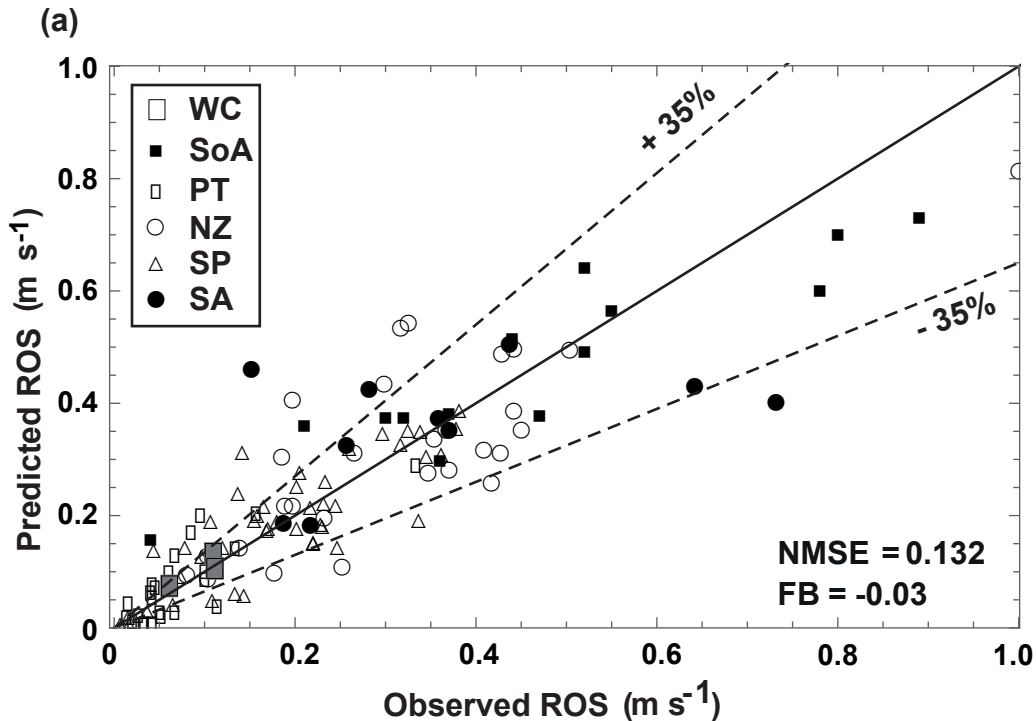



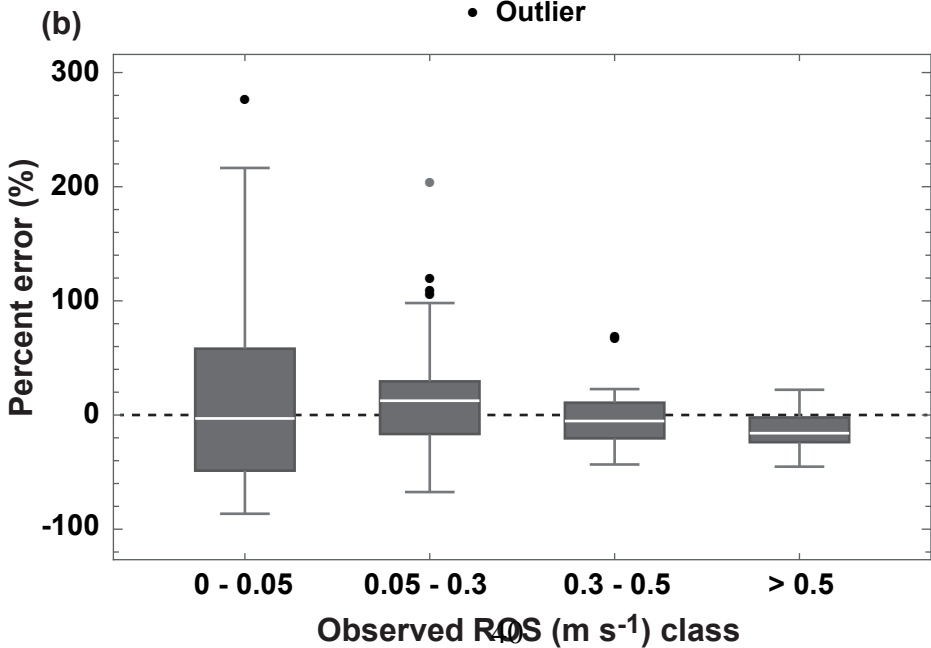
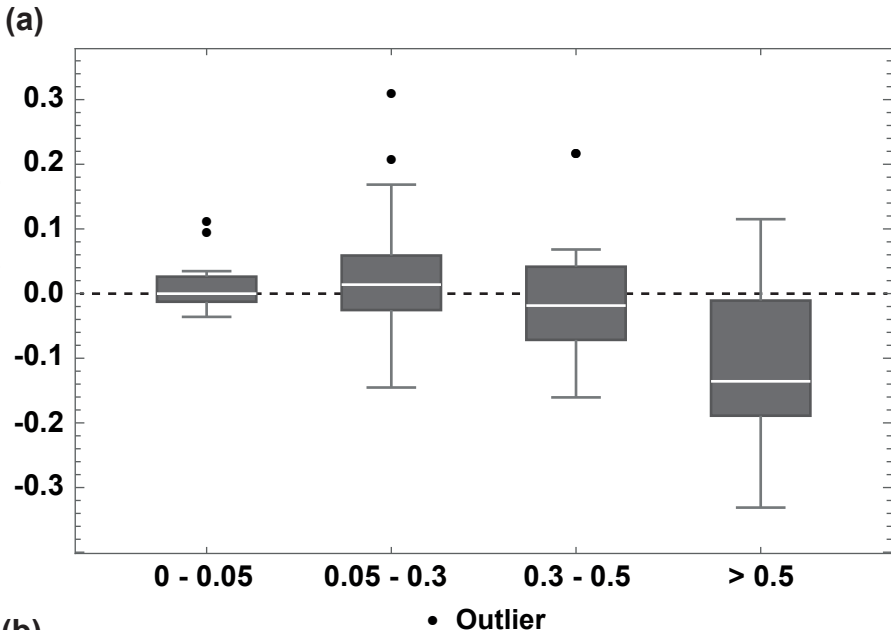

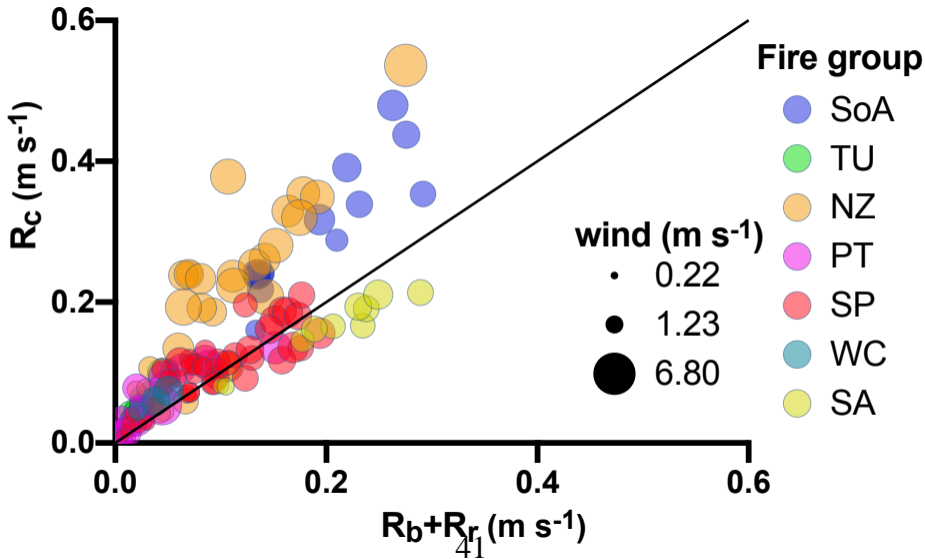

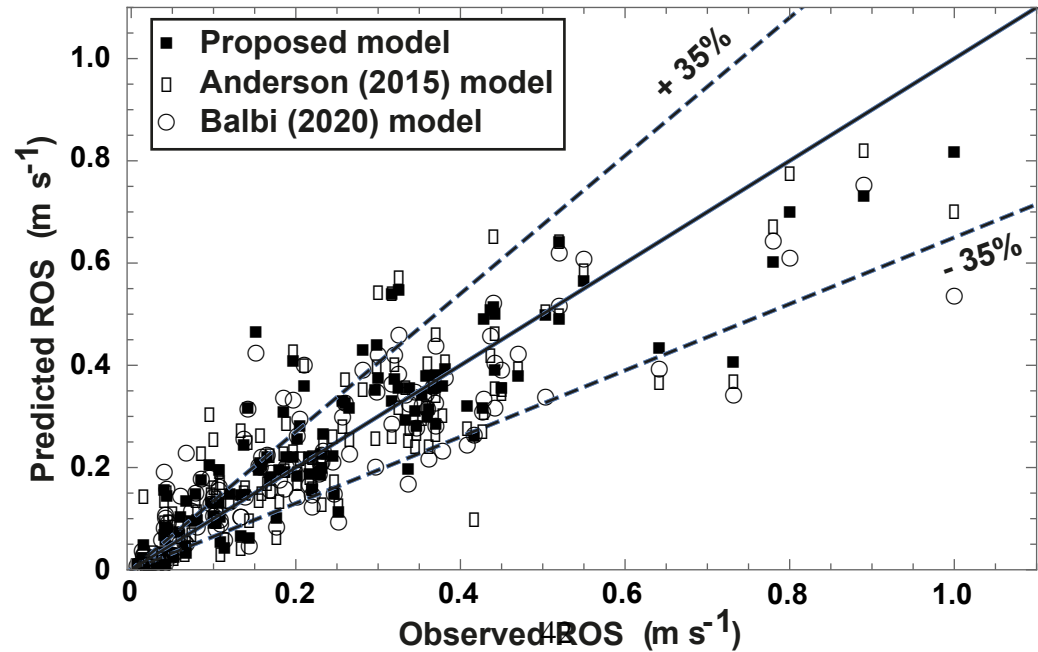

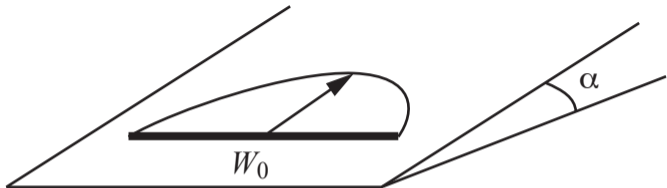

b)

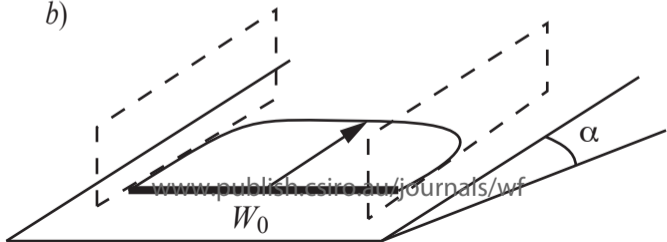

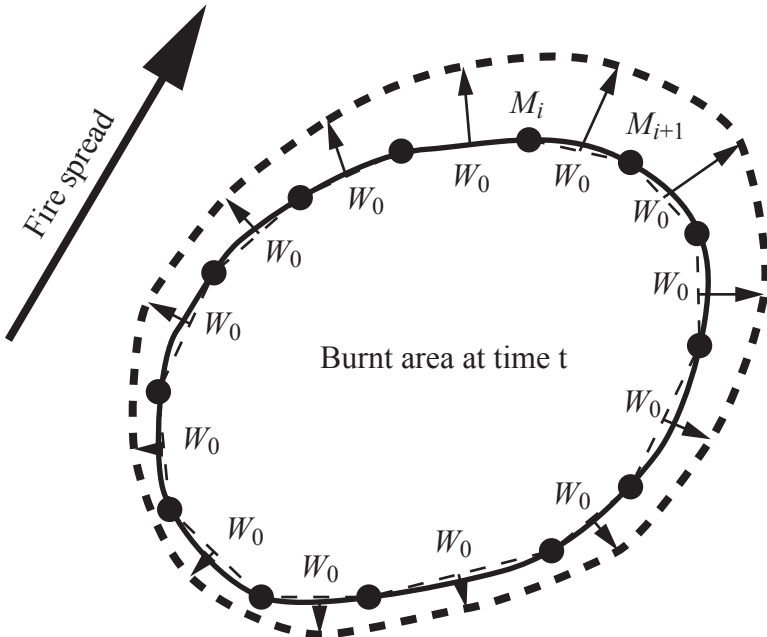

- Points  $M_i$  of the fire contour
- Fire contour at time  $t$
- - - Fire contour at time  $t + \Delta t$

*Latin symbols*

---

$A$	Radiant coefficient	
$a$	Scaling factor	
$a_{lab}, a_{liv}, a_{up}$	Intermediate Scaling factors	
$a_M$	Fitted model parameter	= 0.025
$B$	Stefan-Boltzmann constant ( $W m^{-2} K^{-4}$ )	= $5.6 \times 10^{-8}$
$C_{pw}$	Specific heat of water ( $J kg^{-1} K^{-1}$ )	= 4180
$C_p$	Specific heat of fuel ( $J kg^{-1} K^{-1}$ )	
$C_{pa}$	Specific heat of air ( $J kg^{-1} K^{-1}$ )	= 1150
$g$	Gravity acceleration ( $m s^{-2}$ )	= 9.81
$h$	Fuel bed depth (m)	
$H$	Flame height (m)	
$K$	Law for drag forces	
$K_1$	Drag coefficient ( $s m^{-1}$ )	= 130
$L$	Flame depth (m)	
$l$	Flame length (m)	
$m$	Fuel moisture content	
$q$	Ignition energy ( $J kg^{-1}$ )	
$r_{00}$	Model coefficient	= $2.5 \cdot 10^{-5}$
$R$	Rate of fire spread ( $m s^{-1}$ )	
$R_b$	Contribution of radiation of burning fuel bed to the ROS ( $m s^{-1}$ )	
$R_c$	Contribution of convection to the ROS ( $m s^{-1}$ )	
$R_r$	Contribution of flame radiation to the ROS ( $m s^{-1}$ )	
$s$	Surface area to volume ratio of fuel ( $m^{-1}$ )	
$S$	Leaf area by square meter ( $m^2 m^{-2}$ )	
$s_t$	Air-pyrolysis gases mass ratio in the flame body	= 17
$T$	Mean flame temperature (K)	
$T_a$	Ambient temperature (K)	= 300
$T_i$	Ignition temperature (K)	= 600
$T_{vap}$	Vaporization temperature (K)	= 373
$U$	Sum of normal component (to the fire front) of the natural wind velocity and fire generated inflow coming from the burnt area ( $m s^{-1}$ )	
$U(x)$	Air stream velocity within the burning fuel bed ( $m s^{-1}$ )	
$u_c$	Upward gas velocity at the top of the flame base ( $m s^{-1}$ )	
$u_0$	Upward gas velocity at mid-height flame body on flat terrain ( $m s^{-1}$ )	
$W_0$	Ignition line width (m)	

*Greek symbols*

---

$\alpha$	Terrain slope angle ( $^\circ$ )	
$\beta$	Packing ratio	
$\delta$	Extinction depth	
$\gamma$	Flame tilt angle ( $^\circ$ )	
$\gamma_c$	Angle defined in fig. 1 ( $^\circ$ )	
$\varepsilon$	Flame emissivity	
$\chi$	Radiative fraction	
$\chi_0$	Radiant factor	= 0.3
$\Delta H$	Heat of combustion of the pyrolysis gases ( $J kg^{-1}$ )	= $1.74 \times 10^7$
$\Delta h$	Heat of latent evaporation ( $J kg^{-1}$ )	= $3 \times 10^6$
$\rho_v$	Fuel particle density ( $kg m^{-3}$ )	
$\dot{\sigma}$	Derivative of the dead fuel load over time	

$\sigma$	Dead fine fuel load (kg m <sup>-2</sup> )	
$\phi$	Heat flux per unit length (W m <sup>-1</sup> )	
$\tau_0$	Flame residence time parameter (s m <sup>-1</sup> )	= 75591
$\tau$	Flame residence time (s)	

---

*Subscripts*

<i>a</i>	Related to air
<i>b</i>	Related to the flame base
<i>c</i>	Related to the convective warming
<i>r</i>	Related to the flame body
<i>t</i>	Related to total fuel (dead and live fuel)
<i>w</i>	Related to the fuel water

---

*Acronyms*

CFD	Computational fluid dynamics
FB	Fractional bias
FMC	Fuel moisture content
LAI	Leaf area index
NMSE	Normalized mean square error
ROS	Rate of spread

---

Parameter	Default value	Effect on ROS	
		(+10%)	(-10%)
Surface area to volume ratio (m <sup>-1</sup> )	6000	+8.9%	<b>-10.4%</b>
Fuel density (kg m <sup>-3</sup> )	500	<b>-12.2%</b>	<b>+13.6%</b>
Heat of combustion of pyrolysis gases (J kg <sup>-1</sup> )	1.74 × 10 <sup>7</sup>	<b>10.8%</b>	<b>-10.2%</b>
Fuel specific heat (J kg <sup>-1</sup> K <sup>-1</sup> )	2000	-8.4%	+9.8%
Fuel height (m)	0.5	+4.9%	-5.1%
Dead fuel moisture content	0.1	-4.4%	+4.7%
Dead fuel loading (kg m <sup>2</sup> )	0.3	+0.8%	-1.5%
Total fuel loading (kg m <sup>2</sup> )	0.5	-3.5%	+2.7%



<b>Dataset [nb of fires]</b>	<b>NMSE [FB]</b>			
	<b>Proposed model</b>	<b>Anderson <i>et al</i> (2015) model</b>	<b>Balbi <i>et al</i> (2010) radiative model</b>	<b>Balbi <i>et al</i> (2020) model</b>
New Zealand (NZ) [28]	0.111 [-0.02]	0.190 [-0.09]	30.956 [-1.77]	0.188 [-0.15]
Portugal (PT) [24]	0.308 [-0.14]	0.792 [0.04]	12.803 [-1.63]	0.418 [0.05]
Spain (SP) [44]	0.095 [-0.04]	0.095 [-0.16]	9.833 [-1.54]	0.146 [-0.03]
Australia (WC) [3]	0.018 [0.06]	0.146 [0.34]	48.232 [-1.92]	0.093 [0.00]
Australia (SA) [10]	0.213 [0.06]	0.241 [-0.08]	1.796 [-0.88]	0.261 [-0.04]
South Africa (SoA) [14]	0.048 [0.09]	0.056 [0.2]	9.735 [-1.53]	0.058 [0.16]
All [123]	0.132 [-0.03]	0.180 [-0.05]	11.528 [-1.56]	0.183 [-0.02]

## Appendix A – Models for comparison purpose

### *Balbi et al. (2010) model*

The first version of the Balbi model was presented in 2007. This simplified semi-physical model (Balbi *et al.* 2007) was designed to be used in operational situations. Following Albini (1985, 1986), this model assumed that radiation was the main heat transfer mode. But several limitations appeared: (1) some physical characteristics of the fire front were defined thanks to empirical relationships (for instance, the flame height is obtained with the McCaffrey correlation (McCaffrey 1979)); (2) many model parameters varied from a fire to another which lead to a non predictive model. Balbi *et al.* (2009) suggested the replacement of empirical relationships by physical laws. Actually, the flame height expression was derived from the equation for the vertical momentum applied to the flame and replaced the McCaffrey correlation. Balbi *et al.* (2010) came up with a better modelling for the radiative fraction and introduced a fresh cooling which models the backfire better. This improved radiative model was successfully applied to a set of laboratory experiments performed by Viegas (2004), under strong wind velocities (up to 11 m s<sup>-1</sup>) with non-parallel wind and slope conditions. Moreover Weise *et al.* (2016) showed that the results given by this radiative model applied to laboratory experiments across litter fuel beds provided good results. But some shortcomings remained: (1) the model was still restricted to radiation heat transfer and then poorly represented a fire spread in well-ordered, vertically oriented fuel beds where convection is the dominant heat transfer mechanism (Wolff *et al.* 1991; Finney *et al.* 2013) and (2) the model still had empirical parameters and thus was not a predictive one. Later this last point was corrected and led to the radiative Balbi model defined by Eqn A1.

$$R = \min\left(\frac{S_t}{\pi}, 1\right) \left(\frac{S}{S_t}\right)^2 \frac{BT^4}{\beta\rho_v q} + AR \frac{(1 + \sin \gamma - \cos \gamma)}{1 + \frac{R \cos \gamma}{sr_{00}}} \quad (A1)$$

This model is fully predictive and a good agreement is obtained when it is compared to laboratory experiments in which radiation is the heat dominant transfer mechanism. Note that Eqn A1 is a two order polynomial equation and its solution is given by:

$$R = \frac{-(r_0 - R_b \cos \gamma - r_0 A (1 + \sin \gamma - \cos \gamma)) + ((r_0 - R_b \cos \gamma - r_0 A (1 + \sin \gamma - \cos \gamma))^2 + 4r_0 R_b \cos \gamma)^{\frac{1}{2}}}{2 \cos \gamma} \quad (\text{A2})$$

*Anderson et al. (2015) shrubland model*

Anderson *et al.* (2015) developed two generic-empirical models based on an extended dataset of shrubland fires. In the comparative model analysis used here we used the fuel height model (in the present notations and units):

$$R = \frac{1}{60} 5.6715 (3.6 U)^{0.9102} h^{0.2227} \exp(-7.662 m) \quad (\text{A3})$$

With  $U$  being wind speed ( $\text{m s}^{-1}$  in the equation above) measured at 10-m in the open,  $h$  being fuel height (m) and  $m$  the moisture content of dead fine fuels. A correction is done for fires spreading in zero-wind conditions in order to avoid zero-ROS. This model is designed for fires with a fireline width ( $W_0$ ) greater than 50 m. Otherwise, Anderson and her co-authors adapted Eqn A3 in order to take into account fireline width in the following way:

$$R = \left( \frac{1}{60} 5.6715 (3.6 U)^{0.9102} h^{0.2227} \exp(-7.662 m) \right) \frac{1}{1 + 9 \exp(-0.00316 W_0^2)} \quad (\text{A4})$$

*Balbi et al. (2020) model*

Balbi *et al.* (2020) combined the modelling approach of Chatelon *et al.* (2017) that incorporate convective heat transfer with its radiative only model (Eqn A1) (Balbi *et al.* 2010) in order to obtain a complete simplified physical model that explicitly take into account convective and radiative heat transfer. The main equation of the model is written as follows (see (Balbi *et al.* 2020) for details):

$$R = \min \left( \frac{S}{\pi} 1 \right) \frac{BT^4}{\beta \rho_v q} + \frac{s \Delta H}{q \tau_0} \min \left( h, \frac{2\pi}{s\beta} \right) \left( \frac{h}{2h+H} \tan \alpha + \frac{U \text{Exp}(-K_1 \beta^{\frac{1}{2}} R)}{u_0} \right) + AR \frac{1 + \sin \gamma - \cos \gamma}{1 + \frac{R \cos \gamma}{s r_{00}}} \quad (\text{A5})$$

## Appendix B – Fire ignition line length

The improved model is a steady-state simplified physical model which gives the ROS for the most advanced point of the head fire front as shown in Fig. 8. The fuel bed width is usually small at laboratory scale (more or less 1 m) and the heat loss on the lateral edges of the fuel bed may be important and may play a role on the fire spread. But if the experimental apparatus is equipped with lateral walls, there is no lateral heat loss. As the (Catchpole *et al.* 1998) laboratory experiments were carried out across fuel beds lined with lateral walls, the model proposed by Balbi *et al.* (2020) does not take into account this lateral heat loss effect and the factor  $a_{lat}$  (Eqn 12) does not explicitly appear in the model because it is always equal to 1.

At field scale, except for trench fires, this effect may influence the head fire rate of spread only if the fireline width  $W_0$  is smaller than a certain value. It is assumed that this effect does not play any role on the  $R$  if  $W_0$  is greater than 50 m, which leads to the expression of the factor  $a_{lat}$  (Eqn 12).

The improved model is designed to be used under field operational conditions. For instance, if the model is inserted into a simulator, it does not need any mesh to calculate the fire contour. Each point of the fire perimeter at time  $t+\Delta t$  is obtained with the external unit normal vector to the fire front from the fire perimeter at time  $t$ . As presented in Fig. 11,  $W_0$  represents the distance between two consecutive points of the fire perimeter at time  $t$ . Indeed, as showed in Fig. 9, two points ( $M_i, M_{i+1}$ ) of the fire contour at time  $t$  allow the calculation of a point of the new fire contour at time  $t+\Delta t$  and  $W_0$  which is the distance between  $M_i$  and  $M_{i+1}$ , acts as a new ignition line length. This is one major advantage of the model.

## 1 Appendix C – Expression of the convective heat flux

2 The convective heat flux is defined by Eqn 15. Combining Eqns 15, 16 and 18-19 yields

$$3 \quad \phi_c = \frac{\Delta H}{2\tau_0} \sigma s \min(h, \delta) \left( \tan \alpha + U \frac{h}{h + \frac{H}{2}} \frac{\text{Exp}\left(-\frac{\beta_t}{\min\left(\frac{W_0}{50}, 1\right)} R\right)}{u_c} \right) \quad (\text{C1})$$

4 The expression of upward gas velocity  $u_c$  computed at the top of the flame base does not change  
5 from (Balbi *et al.* 2020):

$$6 \quad u_c = \frac{h}{h + \frac{H}{2}} \frac{u_0}{2} \quad (\text{C2})$$

7 Substituting Eqn C2 in Eqn C1, yields:

$$8 \quad \phi_c = \frac{\Delta H}{\tau_0 u_0} \sigma s \min(h, \delta) \left( \frac{u_0 \tan \alpha}{2} + U \text{Exp}\left(-\frac{\beta_t}{\min\left(\frac{W_0}{50}, 1\right)} R\right) \right) \quad (\text{C3})$$

9 Upward gas velocity at flame mid-height  $u_0$  is also slightly changed because of the living part  
10 of the fuel. Indeed, following (Balbi *et al.* 2009), the simplified mass balance at flame mid-  
11 height equilibrate the rate of gas flow which enters the flame and the sum of the pyrolysis gases  
12 flow rate and the flow rate of the fresh air absorbed by the flame:

$$13 \quad \rho u_0 \frac{L}{2} = (s_t + 1) L \dot{\sigma}_u \frac{h_u}{h} \quad (\text{C4})$$

14 where  $\rho$ ,  $s_t$ ,  $h_u$  and  $\dot{\sigma}_u$  are the gas density, a stoichiometric coefficient, the fuel bed depth under  
15 combustion and the derivative of the effective fuel load over time. The modelling of the ratio  
16  $h_u/h$  is the same as in (Balbi *et al.* 2020), except for the leaf area changed in the total leaf area:

$$17 \quad \frac{h_u}{h} = \min\left(1, \frac{h}{\delta}\right) = \min\left(1, \frac{2\pi}{s_t}\right) \quad (\text{C5})$$

18 Finally, following exactly the calculations performed in Appendix B of (Balbi *et al.* 2020), the  
 19 slight variation of the upward gas velocity is obtained:

$$20 \quad u_0 = 2 \frac{(s_t + 1) \rho_v T}{\tau_0 \rho_a T_a} \min \left( S, \frac{2\pi S}{s_t} \right) \quad (\text{C6})$$

21 Moreover, using the definition of the leaf area  $S = s h \beta$  and extinction depth  $\delta = 2\pi/(s \beta_t)$  the  
 22 following simplification is obtained:

$$23 \quad \min \left( S, \frac{2\pi S}{s_t} \right) = \min \left( s h \beta, \frac{2\pi \beta}{\beta_t} \right) = s \beta \min \left( h, \frac{2\pi}{s \beta_t} \right) = s \beta \min (h, \delta) \quad (\text{C7})$$

24 Substituting Eqns C6 and C7 in Eqn C3 yields:

$$25 \quad \phi_c = \frac{\Delta H \rho_a T_a}{2(s_t + 1) \rho_v T \beta} \sigma \left( \frac{(s_t + 1) \rho_v T}{\tau_0 \rho_a T_a} \min \left( S, \frac{2\pi S}{s_t} \right) \tan \alpha + U \text{Exp} \left( - \frac{\beta_t}{\min \left( \frac{W_0}{50}, 1 \right)} R \right) \right) \quad (\text{C8})$$

26 Finally, the contribution of the convective effects to the ROS is obtained in combining Eqns 3,  
 27 14 and C8:

$$28 \quad R_c = a_M \min \left( \frac{W_0}{50}, 1 \right) \frac{\Delta H \rho_a T_a s \sqrt{h}}{2q(s_t + 1) \rho_v T} \left( \frac{(s_t + 1) \rho_v T}{\tau_0 \rho_a T_a} \min \left( S, \frac{2\pi S}{s_t} \right) \tan \alpha + U \text{Exp} \left( - \frac{\beta_t}{\min \left( \frac{W_0}{50}, 1 \right)} R \right) \right) \quad (\text{C9})$$

29